

# Greenfield

OUTDOOR PLEASURE



Roberti®

# Greenfield

OUTDOOR PLEASURE

GREENFIELD raccoglie un ricco insieme di proposte per l'arredo residenziale e contract di aree esterne e IN/OUT. Collezioni interpretate con sapiente maestria nella ricerca estetica e materiale al fine di rendere la vita all'aperto un'esperienza di libertà e convivialità rilassata e sospesa nel tempo. Design e materia seguono un filo conduttore di eleganza e perfetta armonia integrandosi nei vari spazi d'ambiente. Lasciatevi ispirare dal lifestyle Roberti.



*GREENFIELD offers a rich collection of proposals for the residential and contract interior decoration for outdoor areas and IN/OUT. The various collections perform the result of a skilful and professional production process joined with a concrete research of design and selection of materials to make the outdoor living an experience of free and relaxing conviviality. Design and materials follow an unique line of elegance and perfect harmony integrating themselves in the different living spaces. Be inspired by the Roberti lifestyle.*

Greenfield Kollektion bietet ein reiches Sortiment für die Wohnung und für die Kontrakt-Branche an, wie auch für den IN/OUT Bereich. Die Vielfalt der Kollektionen kann die fachliche Meisterschaft, das gelernte Design und die Materialien-Suche bestens ausdrücken. Das Outdoor Leben wird somit eine freie, entspannende Lebenserfahrung die man gerne im Freundeskreis teilt. Design und Materialsuche folgen eine einzige elegante Linie und integrieren sich harmonisch in den verschiedenen Ambiente. Lassen Sie sich von Roberti Lifestyle inspirieren.

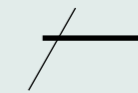

*GREENFIELD offre un riche ensemble de propositions pour l'ameublement résidentiel et prescription des espaces extérieurs et IN/OUT. Les différentes collections savent interpréter une grande maîtrise et une recherche constante de design et matériaux pour rendre la vie à l'extérieur une expérience unique et relaxante. Design et matière suivent un fil conducteur d'élegance et harmonie et sont capables de s'intégrer dans les situations les plus différentes. Laissez-vous inspirer par le lifestyle de Roberti.*

# The story begins

searching for

balance  
between  
body and

**SOUL** |



**indice**  
table of contents

04 / 27

Lipari

Design: A. De Marco - S. Fanciullacci

28 / 59

Capri

Design: S. Sevellano

60 / 71

Gravity

Design: Technical Emotions

72 / 81

Atollo

Design: A. De Marco-Simone Fanciullacci

82 / 101

Portofino

Design: Studio Balutto Associati - S. Sevellano

102 / 113

Coral Reef

Design: S. Sevellano

114 / 131

Hamptons Graphics

Design: G.V. Plazzogna - R. Papparotto

132 / 139

Hamptons

Design: G.V. Plazzogna - R. Papparotto

140 / 143

Caribe

Design: Studio Balutto Associati

144 / 149

St. Tropez

Design: Studio Balutto Associati

150 / 153

Igloo

Design: Studio Balutto Associati

154 / 167

Samba Rio

168 / 171

Technical Data & Materials

172 / 177

Fabrics & Covers

178 / 193

Drawings



01/

# Lipari

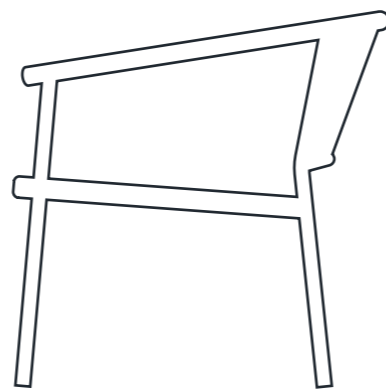

Un tratto essenziale ed elegante delimita le forme accoglienti di sedie, divano e poltrone. L'intreccio in searope ripercorre sentieri della memoria. Una bellezza abbagliante quanto il sole delle isole.

*An essential and elegant trait defines the cosy shapes of the chairs, sofas and armchairs. The Searope weaving goes back over the paths of memory. A dazzling beauty as the sunshine in the islands.*

Ein wesentliches und elegantes Merkmal erhebt die gemütliche Form der Stühle, Sofas und Sesseln. Das Geflecht Searope erweckt die Erinnerung an die Vergangenheit. Eine blendende Schönheit wie die Sonne auf den Inseln.

*Un trait essentiel et élégant délimite les formes accueillantes des chaises, canapés et fauteuils. Le tressage en Searope revient sur le cours des souvenirs. D'une beauté éblouissante comme le soleil des îles.*



Lipari (graphite\_oval searope silver) (iride beige\_dune beige) art. 4341 poltrona\_armchair\_Sessel\_fauteuil



Lipari (graphite\_oval searope silver) (iride beige\_dune beige\_natte bianco)  
art. 4341 poltrona\_armchair\_Sessel\_fauteuil  
art. 4342 divano\_Sofa\_canapé



Lipari (graphite)  
art. 4348H tavolino h. 41\_low coffee table h. 41\_Clubtisch H. 41\_table basse h. 41 (hpl slate stone)  
art. 4349H tavolino h. 36\_low coffee table h. 36\_Clubtisch H. 36\_table basse h. 36 (hpl slate stone)



hpl slate stone



Lipari (graphite\_oval searope silver\_barvline pepper)  
art. 4331 sedia\_chair\_Sessel\_chaise

Capri (graphite\_round searope dark grey)  
art. 4326 tavolo\_table\_Tisch  
(hpl light slate)

stay with  
**friends**



Lipari (graphite\_oval searope silver\_batyline pepper)  
art. 4331 sedia\_chair\_Sessel\_chaise

Capri (graphite\_round searope dark grey)  
art. 4326 tavolo\_table\_Tisch  
(hpl light slate)



Lipari (graphite\_oval searope silver) (iride turchese) art. 4331 sedia\_chair\_Sessel\_chaise  
Samba Rio (graphite) art. 9586R base tavolo\_table base\_Tischgestell\_base table  
art. 9682 piano\_top\_Tischplatte\_plateau (hpt slate stone)

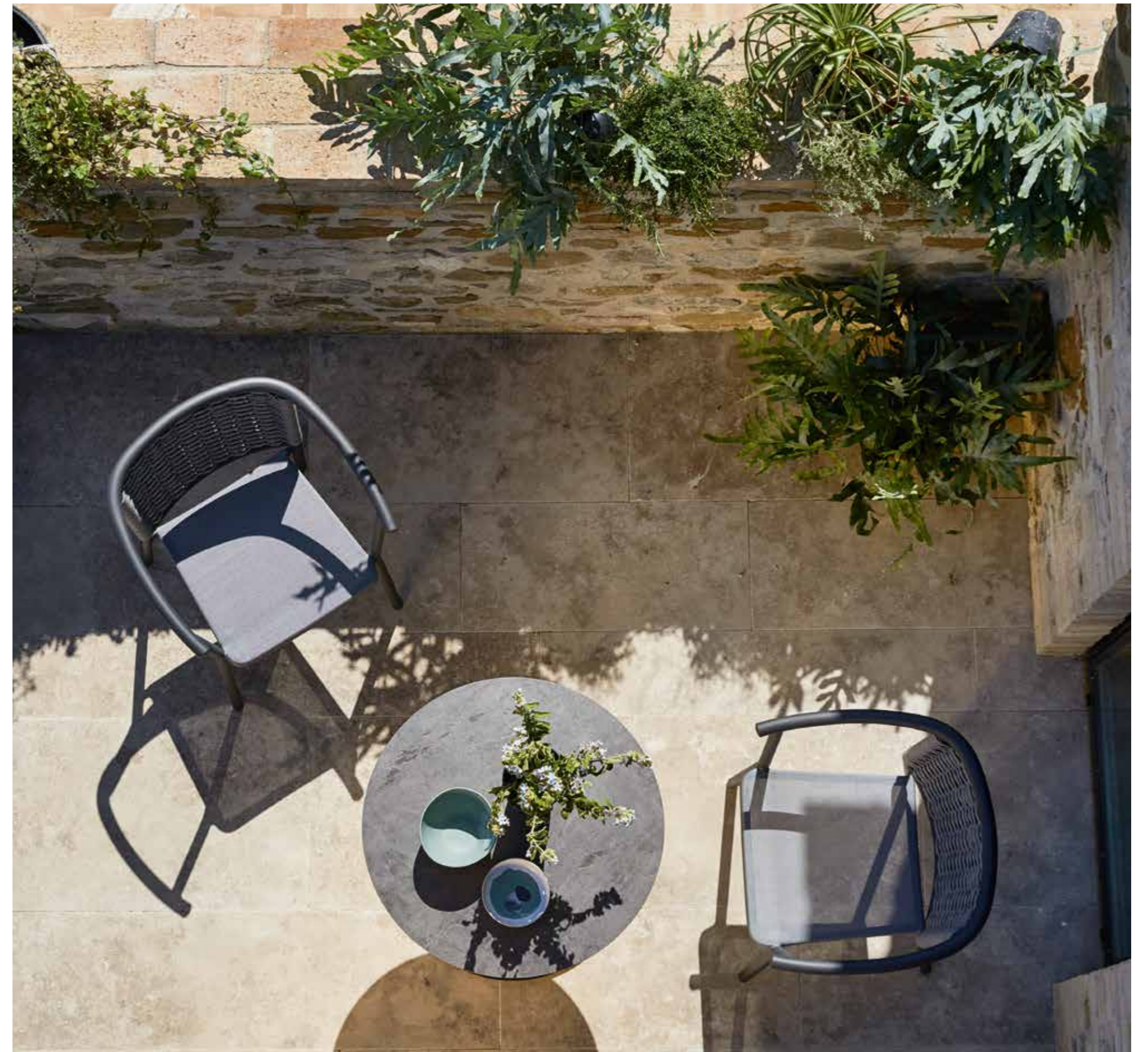

Lipari (graphite\_oval searope silver\_batyline pepper) art. 4331 sedia\_chair\_Sessel\_chaise



Lipari (white\_oval searope pearl) (iride turchese\_dune turchesi\_natte bianco) art. 4341 poltrona\_armchair\_Sessel\_fauteuil  
art. 4342 divano\_Sofa\_canapé art. 4348H tavolino h. 41\_low coffee table h. 41\_Clubtrisch H. 41\_table basse h. 41 (hpl marble white)  
art. 4349H tavolino h. 36\_low coffee table h. 36\_Clubtrisch H. 36\_table basse h. 36 (hpl marble white)

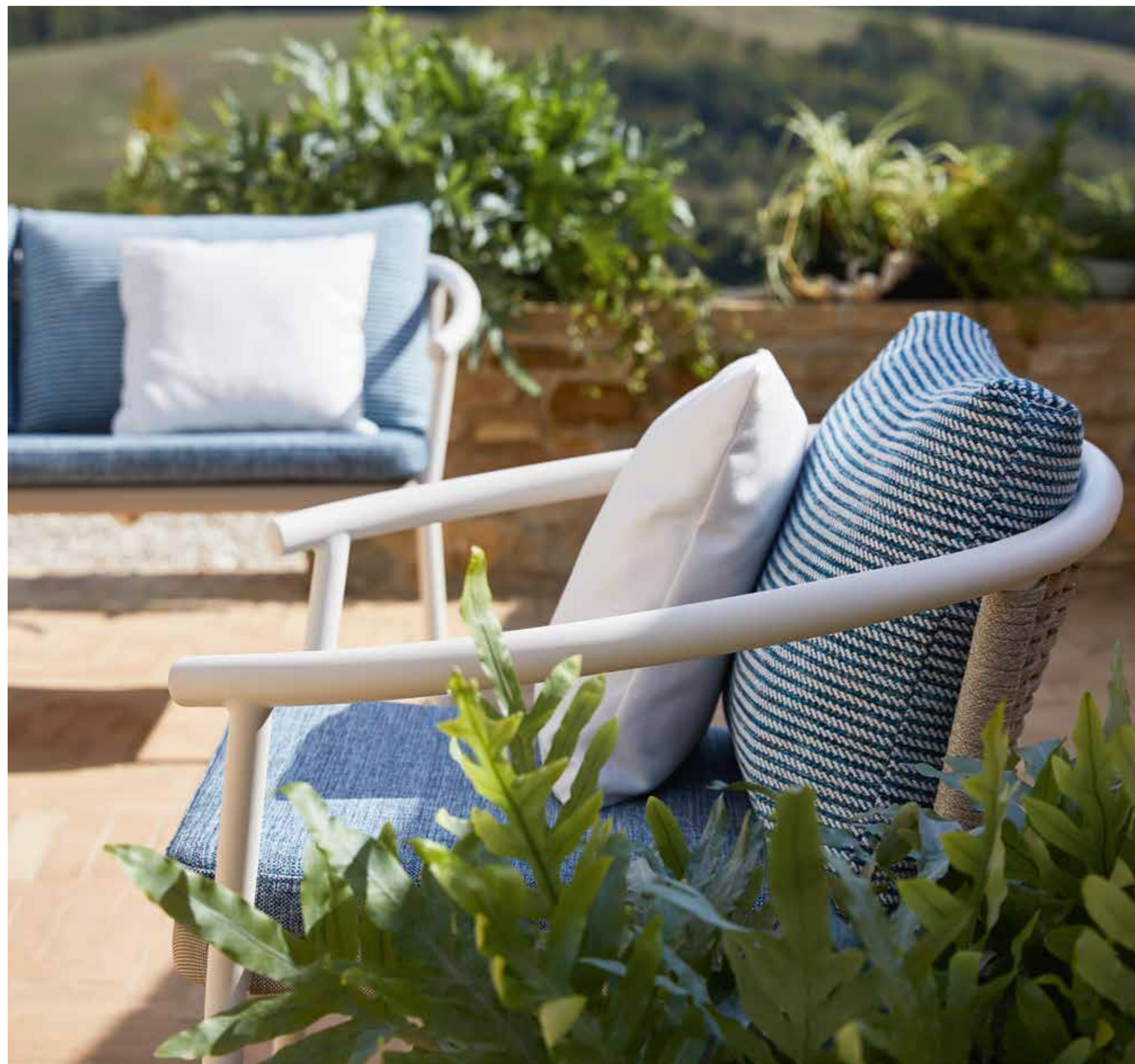

Lipari (white\_oval searope pearl)  
(iride turchese\_dune turchesi\_natte bianco)  
art. 4341 poltrona\_armchair\_Sessel\_fauteuil



Lipari (white\_oval searope pearl) (iride turchese\_dune turchesi\_natte bianco)  
art. 4341 poltrona\_armchair\_Sessel\_fauteuil



Lipari (white\_oval searope pearl\_batyline walnut) (dune turchesi\_natte bianco) art. 4341 poltrona\_armchair\_Sessel\_fauteuil  
art. 4342 divano\_Sofa\_canapé art. 4348H tavolino h. 41\_low coffee table h. 41\_Clubtrisch H. 41\_table basse h. 41 (hpl marble white)  
art. 4349H tavolino h. 36\_low coffee table h. 36\_Clubtrisch H. 36\_table basse h. 36 (hpl marble white)





# FREE yourself

and listen to  
your \_\_\_\_\_ feelings

Lipari (white\_oval searope pearl) (dune turchesi)  
art. 4331 sedia\_chair\_Sessel\_chaise  
art. 9775 tavolo\_table\_Tisch (hpl marble white)



Lipari (white\_oval searope pearl) (dune turchesi) art. 4331 sedia\_chair\_Sessel\_chaise  
art. 9775 tavolo\_table\_Tisch (hpl marble white)



hpl marble white



Lipari (white\_oval searope pearl) (dune turchesi)  
art. 4331 sedia\_chair\_Sessel\_chaise



Lipari (white\_oval searope pearl\_batyline walnut)  
art. 4331 sedia\_chair\_Sessel\_chaise  
art. 4349H tavolino\_low coffee table\_Clubtisch\_table basse (hpl marble white)





## 02 Capri

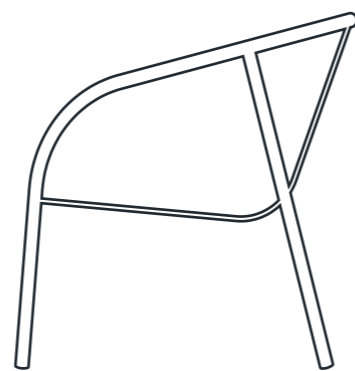

La progettualità delle linee rivisita e reinterpreta uno stile di vita intramontabile. Scenari unici evocati da una collezione sobria e glamour allo stesso tempo; vitale ed inimitabile nel suo unico mix di eleganza internazionale.

*The planning of the lines revisits and expresses a timeless lifestyle. Unique scenarios evoked by a glamorous and clean collection at the same time, vital and incomparable in its mix of international elegance.*

Die Kreativität der Linien erneuert sich und bietet einen zeitlosen Lebensstil an. Einzigartige Szenarien werden von der nüchternen Kollektion mit Glamour hervorgerufen; lebenswichtig und unvergleichlich in seinem außergewöhnlichem internationalem Mix.

*La conception des lignes revisite et réinterprète un style de vie intemporel. Un scénario unique évoqué par une collection sobre et glamour au même temps; vitale et incomparable dans le mix de élégance internationale.*



Capri (graphite\_round searope dark grey) (iride beige\_dune beige)





Capri (graphite\_round searope dark grey) (iride beige\_dune beige) art. 4311 poltrona\_armchair\_Sessel\_fauteuil  
art. 4312 divano\_Sofa\_canapé art. 4318H tavolino h. 36\_low coffee table h. 36\_Clubtisch H. 36\_table basse h. 36 (hpl slate stone)  
art. 4319H tavolino h. 45\_low coffee table h. 45\_Clubtisch H. 45\_table basse h. 45 (hpl slate stone)



Capri (graphite\_round searope dark grey) (iride beige\_dune beige) art. 4311 poltrona\_armchair\_Sessel\_fauteuil

Capri (graphite) art. 4319H tavolino\_low coffee table\_Clubtrisch\_table basse (hpl slate stone)





# Dream

about

Capri (graphite\_round searope dark grey)  
(iride beige\_dune beige)  
art. 4312 divano\_Sofa\_canapé



Capri (white round searope pearl) (petra panna)  
art. 4315 poltrona relax relax armchair Relaxsessel fauteuil relax art. 4316 pouf Höcker



what makes you  
**feel good**

be  
more  
relaxed

Capri (white\_round searope pearl)  
art. 4315 poltrona relax\_relax armchair  
Relaxessel\_fauteuil relax  
art. 4316 pouf\_Hocker





Capri (graphite\_round searope dark grey)  
art. 4301 sedia\_chair\_Sessel\_chaise  
Lipari (graphite) art. 9777 tavolo\_table\_Tisch (hpl slate stone)



Capri (graphite\_round searope dark grey)  
art. 4301 sedia\_chair\_Sessel\_chaise  
Lipari (graphite) art. 9777 tavolo\_table\_Tisch (hpl slate stone)





Capri (graphite\_round searope dark grey)  
art. 4301 sedia\_chair\_Sessel\_chaise  
art. 4318H tavolino h. 36\_low coffee table h. 36\_Clubtrisch  
H. 36\_table basse h. 36 (hpl slate stone)  
art. 4319H tavolino h. 45\_low coffee table h. 45\_Clubtrisch  
H. 45\_table basse h. 45 (hpl slate stone)





take  
your  
**time**



Capri (graphite\_round searope dark grey)  
art. 4305 sgabello\_bar stool\_Bar-Hocker\_tabouret bar

Samba Rio (graphite)  
art. 9783 base tavolo bar\_high bar table base  
Bar-Tischgestell\_base table

art. 9682 piano\_top\_Tischplatte\_plateau  
(hpl marble white)

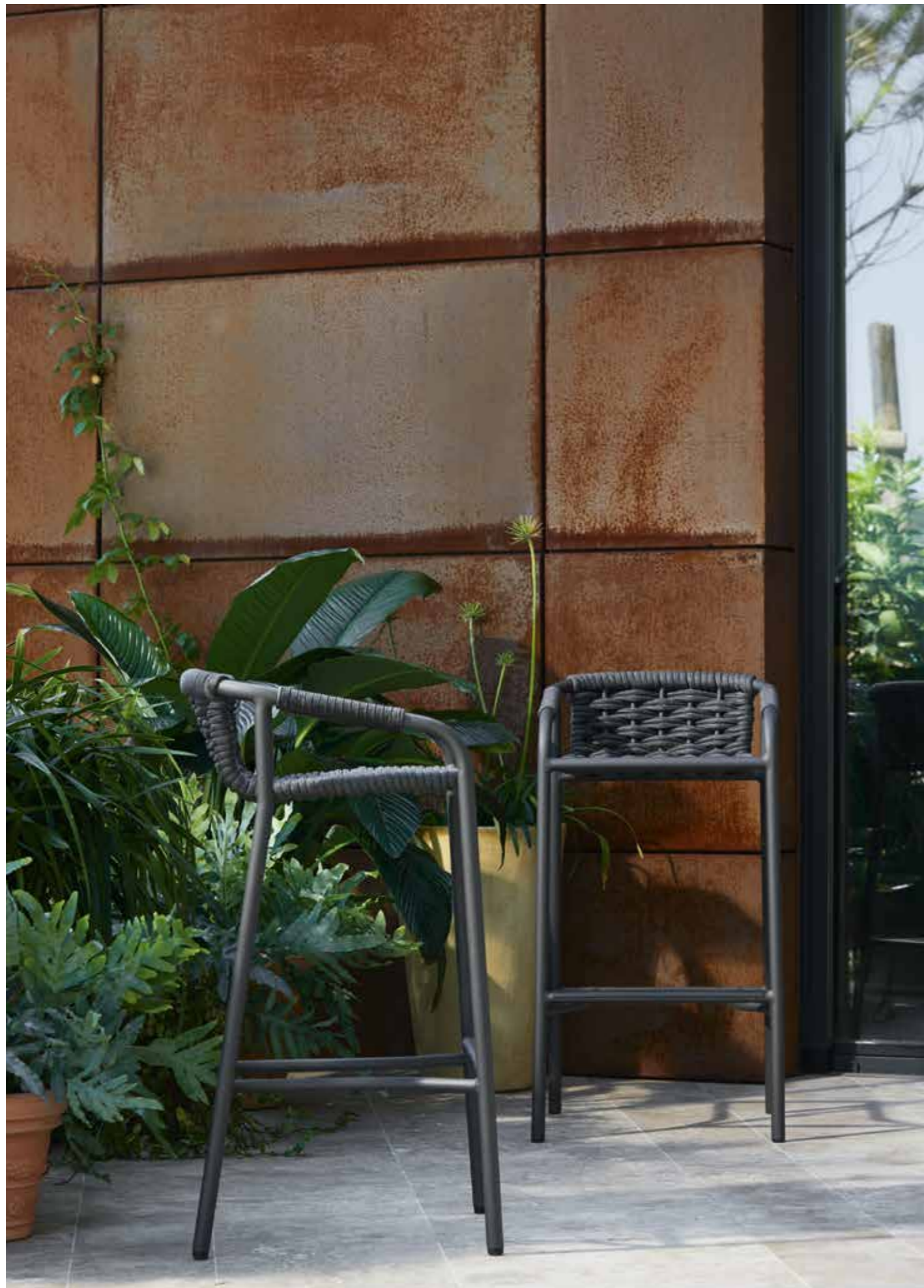

Capri (graphite\_round searope dark grey)  
art. 4305 sgabello \_bar stool\_Bar-Hocker\_tabouret bar



Capri (white\_round searope pearl) (oceano\_emerald) art. 4311 poltrona\_armchair\_Sessel\_fauteuil  
art. 4312 divano\_Sofa\_canapé art. 4318H tavolino h. 36\_low coffee table h. 36\_Clubtisch H. 36\_table basse h. 36 (hpl marble white)  
art. 4319H tavolino h. 45\_low coffee table h. 45\_Clubtisch H. 45\_table basse h. 45 (hpl marble white)



Capri (white\_round searope pearl) (oceano\_emerald) art. 4311 poltrona\_armchair\_Sessel\_fauteuil  
 art. 4312 divano\_Sofa\_canapé art. 4318H tavolino h. 36\_low coffee table h. 36\_Clubtisch H. 36\_table basse h. 36 (hpl marble white)  
 art. 4319H tavolino h. 45\_low coffee table h. 45\_Clubtisch H. 45\_table basse h. 45 (hpl marble white)

Capri (round searope pearl) (hpl marble white)

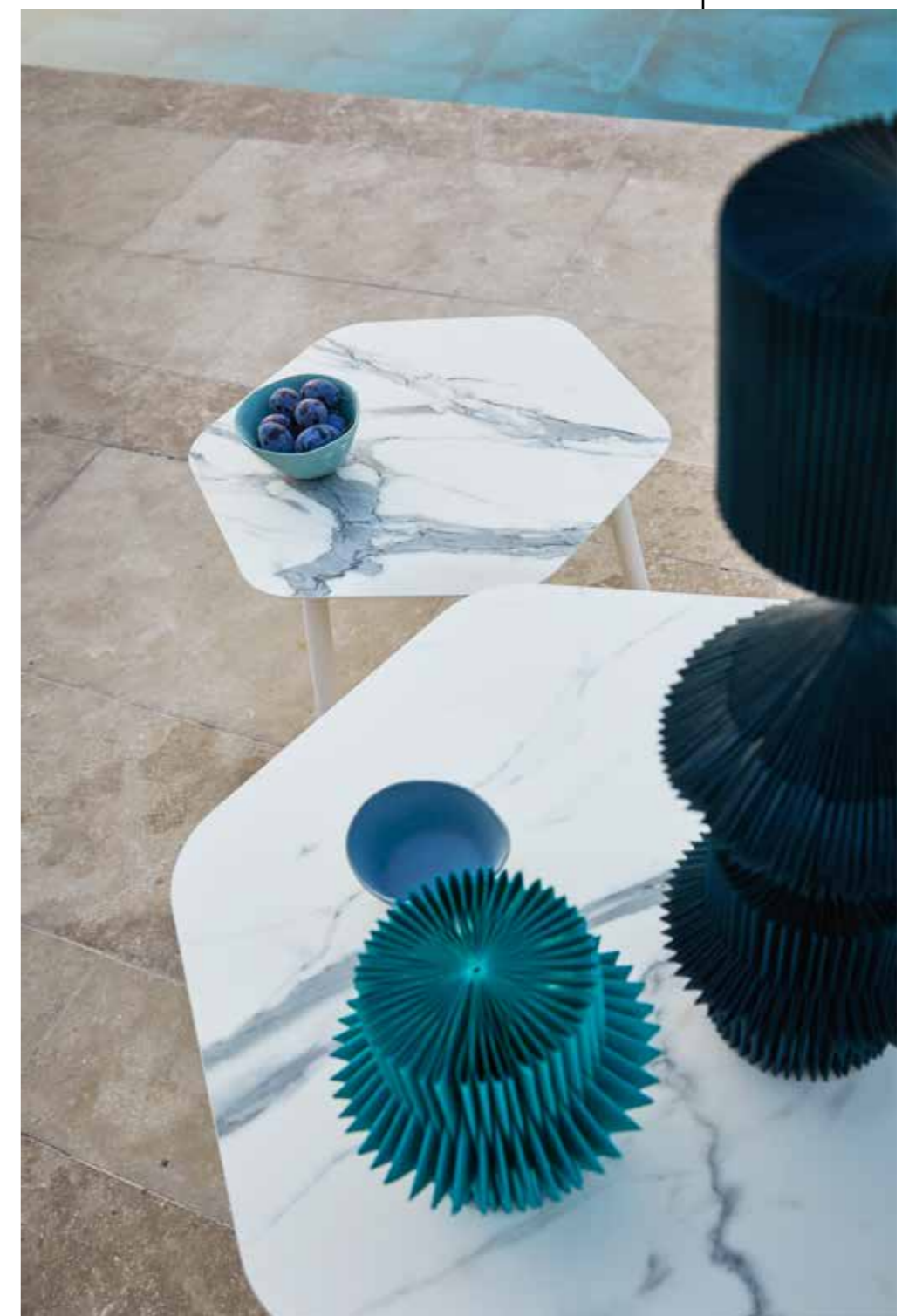

Capri (white\_round searope pearl) (ocean\_ emerald) art. 4311 poltrona \_armchair\_ Sessel\_ fauteuil  
art. 4312 divano \_Sofa\_ canapé art. 4318H tavolino h. 36\_low coffee table h. 36\_Clubtrisch H. 36 \_table basse h. 36 (hpl marble white)  
art. 4319H tavolino h. 45\_low coffee table h. 45\_Clubtrisch H. 45 \_table basse h. 45 (hpl marble white)

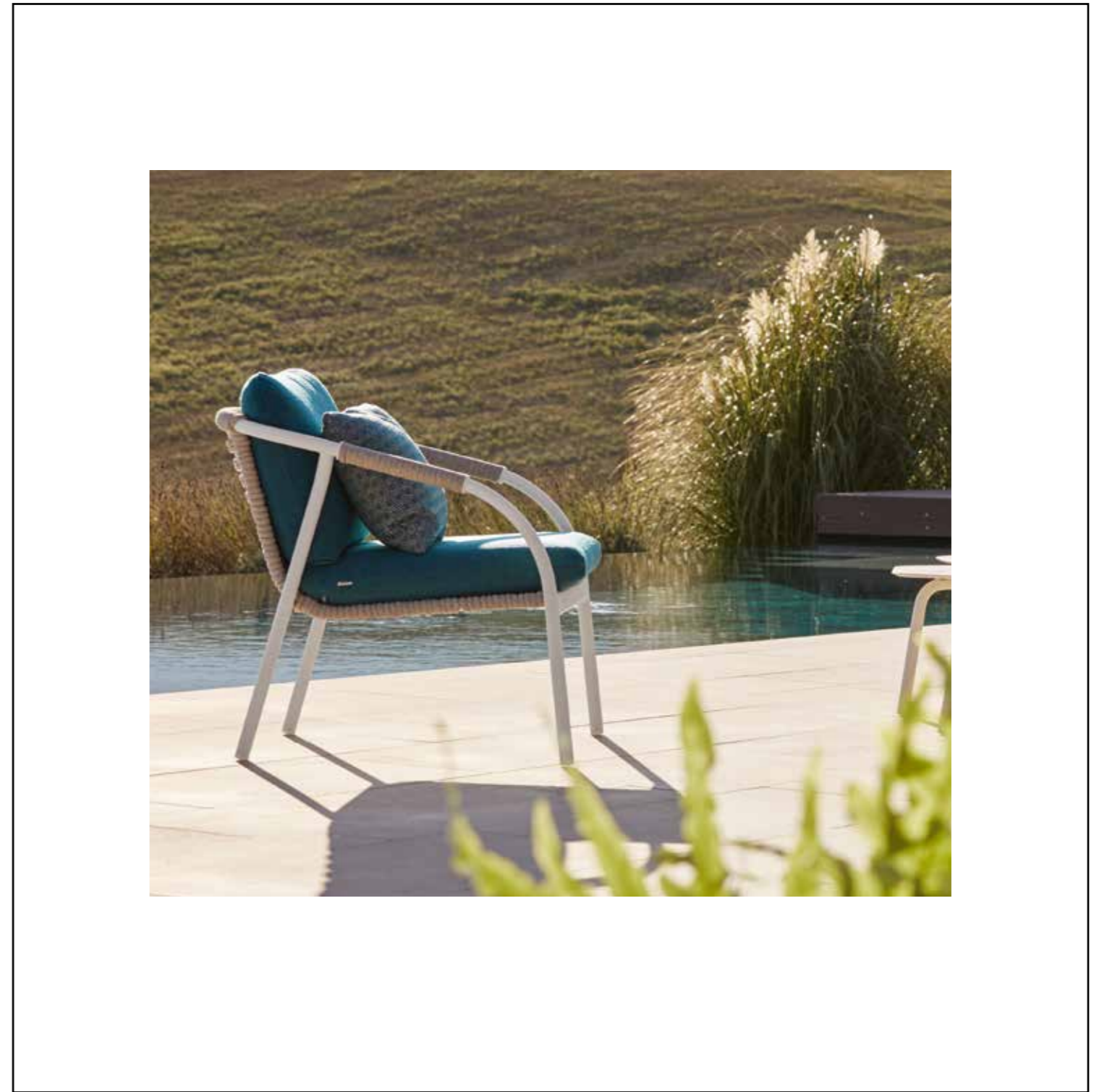
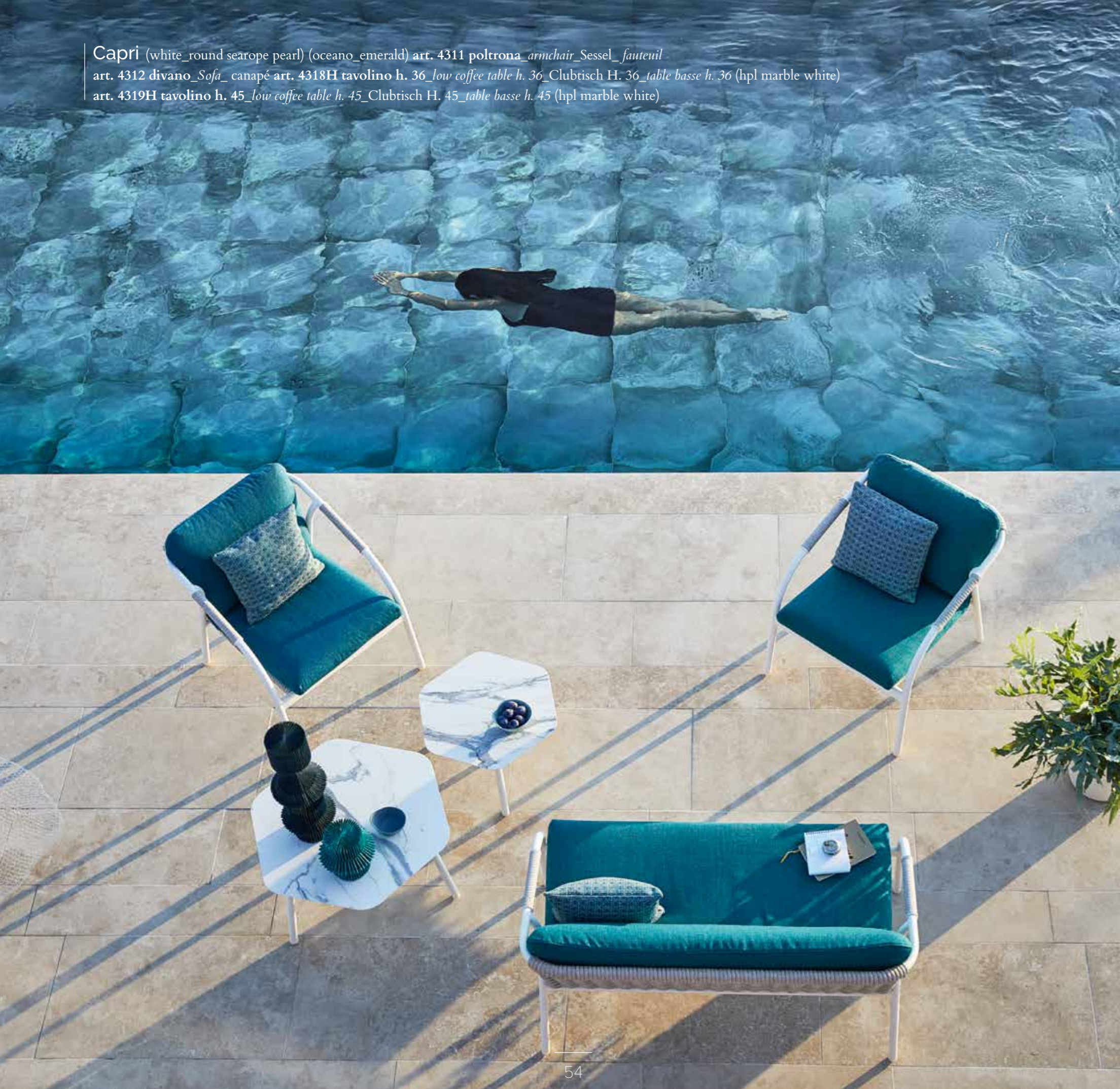

Capri (white\_round searope pearl)  
art. 4301 sedia\_chair\_Stuhl\_chaise  
art. 4326 tavolo\_table\_Tisch (hpl marble white)

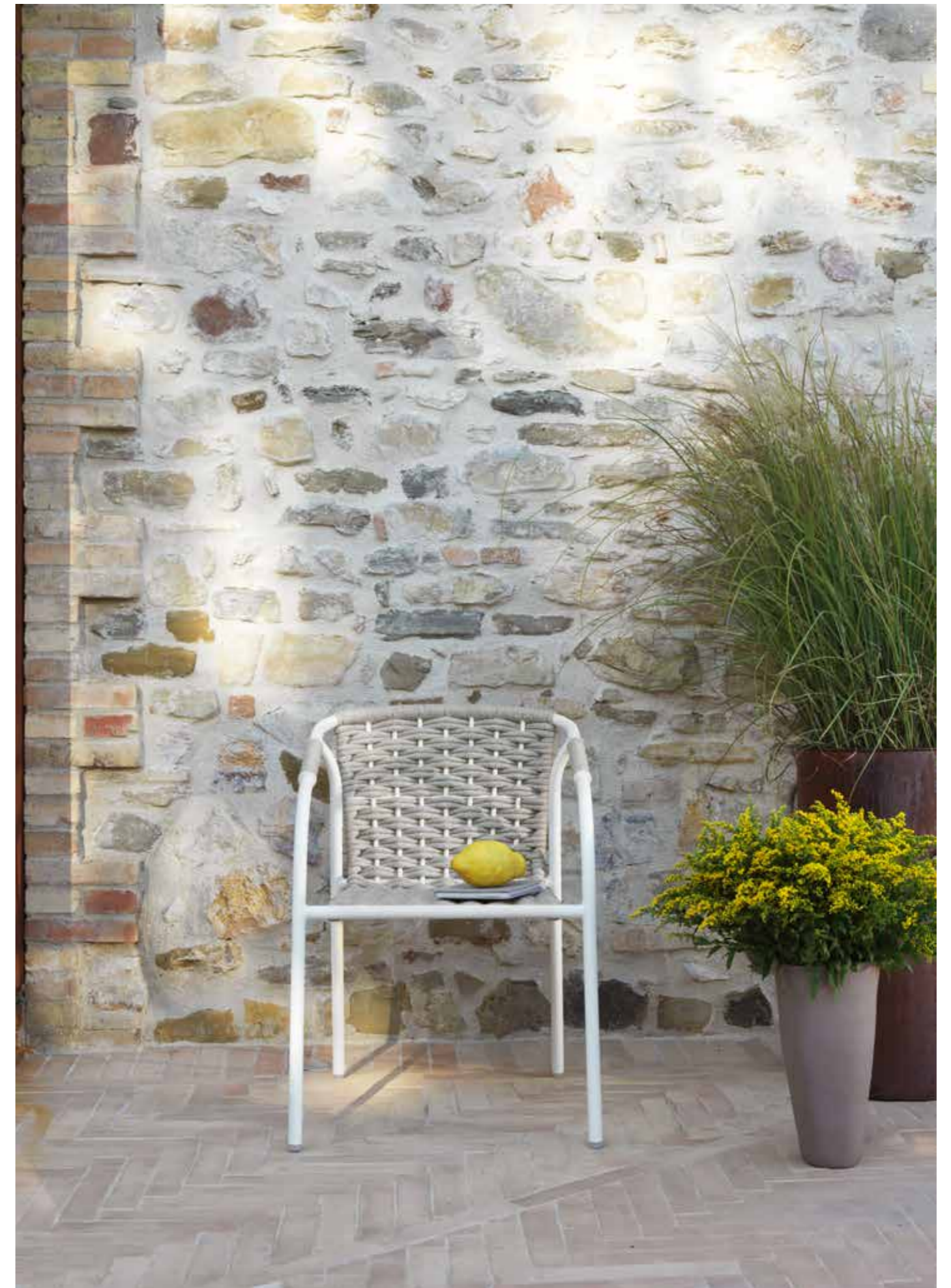



Capri (white\_round searope pearl)  
art. 4301 sedia\_chair\_Sessel\_chaise  
art. 4326 tavolo\_table\_Tisch (hpl marble white)

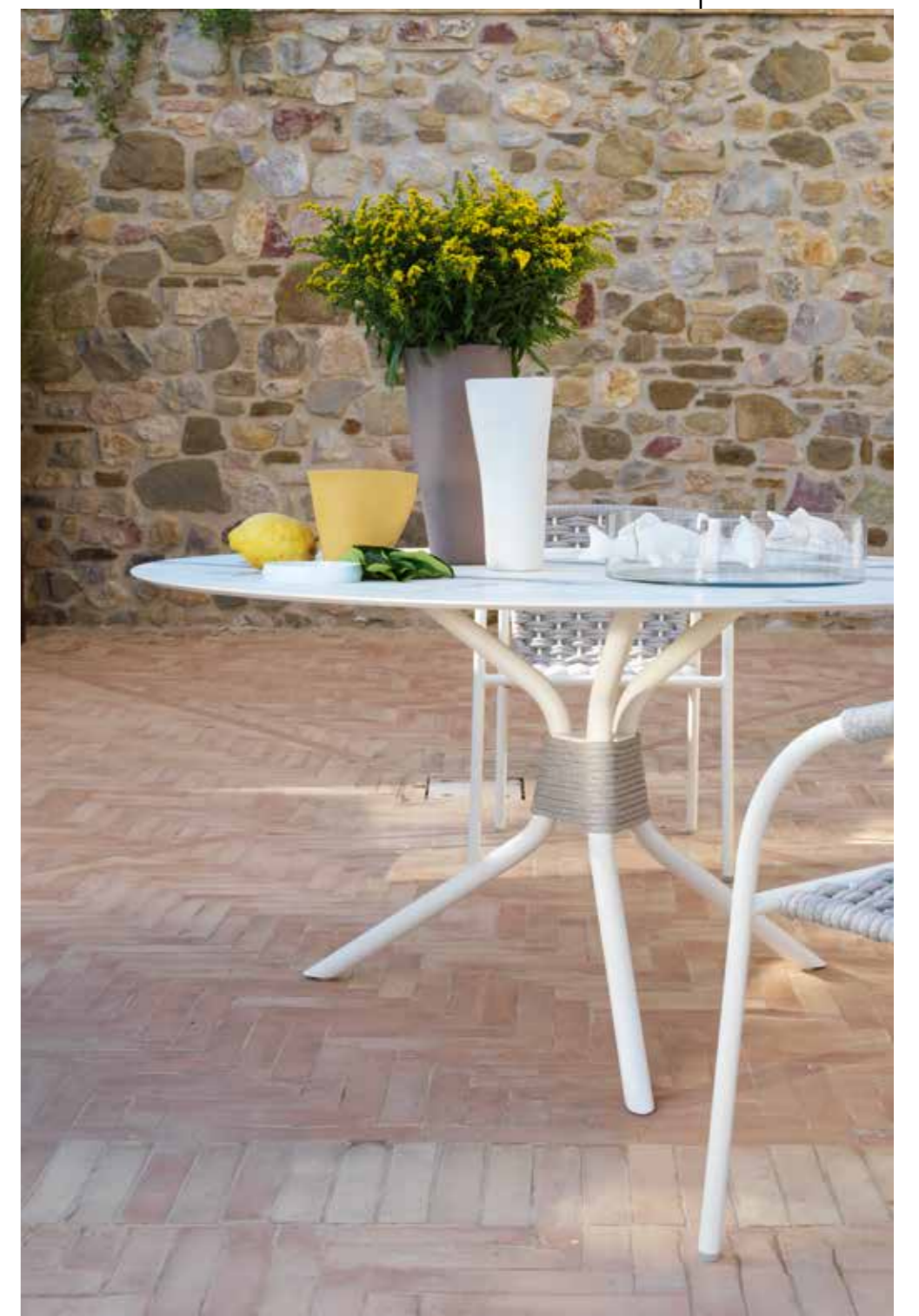



## 03 Gravity

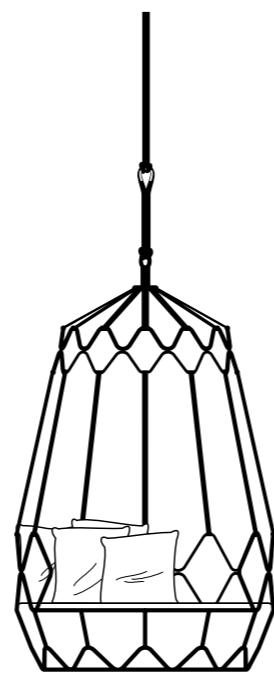

Un divano sospeso che diventa uno spazio intimo e accogliente dove affidarsi al leggero dondolare per un totale rilassamento.

*The new swing-sofa has an intimate welcoming space where you can relax on a light rocking.*

Das neue Swing-Sofa ist eine gemütliche und vertraute Nische für die volle Entspannung durch ein leichtes Schaukeln.

*Le Swing-Sofa offre un coin accueillant et intime pour se relaxer avec un léger balancement.*



Gravity (graphite) (tricot nero\_arabesque) art. 9882 divano\_Sofa\_canapè





Gravity (graphite\_nautic rope black) (tricot nero\_kristal nero\_arabesque)  
art. 9881 divano - dondolo sospeso\_Swing-sofa

Gravity (champagne) (tricot nero\_kristal nero\_righe beige)  
art. 9881 divano dondolo\_Swing-sofa



Gravity (graphite\_nautic rope black)  
(tricot nero\_kristal nero\_arabesque)



Gravity (champagne\_nautic rope sand)  
(tricot nero\_kristal nero\_righe beige)

enjoy  
nature

**Gravity** (champagne\_nautic rope sand)  
art. 9880 divano-dondolo completo di struttura portante  
*swing-sofa with supporting frame\_mit Gestell\_avec structure de support*

art. 9885 tavolino\_coffee table\_Couchtisch\_table basse  
(aluminum top)





Gravity (champagne\_nautic rope sand) (trama bianca\_pistacchio\_rombi verdi)  
art. 9881 divano - dondolo sospeso\_Swing-sofa



Gravity (champagne) (azzurro mare\_trama bianca\_orient azzurro)  
art. 9882 divano\_Sofa  
art. 9886 tavolino\_coffee table\_Couchtisch\_table basse (aluminum top)



## 04/Atollo

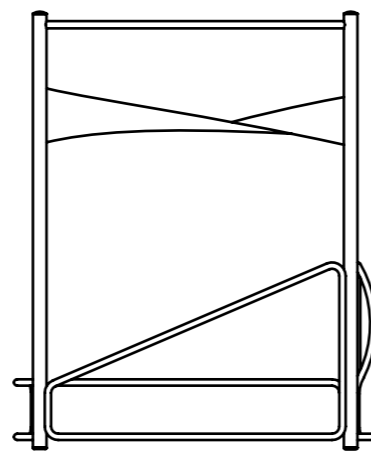

Linee dinamiche e versatilità d'uso si uniscono in una ricerca di stile e vivacità contemporanea nel nuovo maxi daybed. La funzionalità della protezione ombreggiante caratterizza l'estetica in modi sempre diversi. L'ergonomicità della rete di seduta offre il massimo comfort anche non convenzionale.

*Contemporary lines and versatility merge into a research in style and contemporary liveliness in the new maxi daybed. The functionality of the shading protection features the aesthetic in many different ways. The ergonomics of the seat offers the best comfort.*

Das dynamisches Design und die Vielseitigkeit des neuen Daybeds erlauben einen modernen und lebhaften Lifestyle. Die Abschattung ist funktionsfähig und schenkt immer ein neues Aussehen. Das Sitznetz trifft eine gute Ergonomie und erlaubt den maximalen unkonventionellen Komfort.

*Lignes dynamiques et versatilité d'utilisation se mélangent dans une recherche de style et vivacité contemporaine pour le nouveau maxi daybed. La fonctionnalité de la protection et l'ombrage caractérise l'esthétique de manières toujours différentes. L'ergonomie de l'assise offre le maximum confort aussi non conventionnel.*

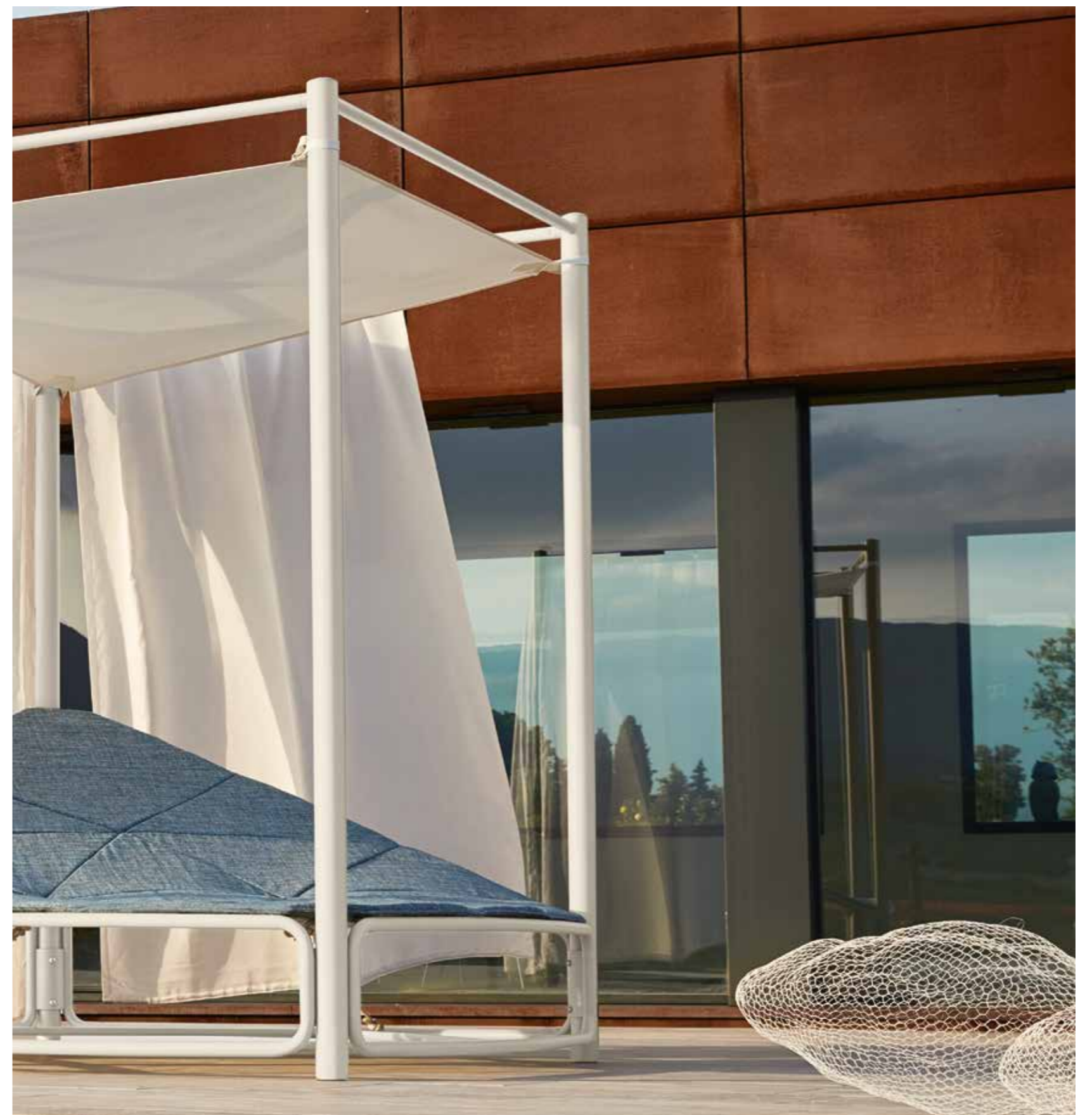

Atollo (white) (iride turchese) art. 4361 day-bed con baldacchino, vela e tende parasole \_canopied day-bed with sun protection and curtains \_Day-Bed mit Himmel-Sonnenschutz und Vorhänge \_day-bed avec parasol et rideaux



Atollo (white) (iride turchese) art. 4361 day-bed con baldacchino, vela e tende parasole\_ canopied day-bed with sun protection and curtains  
Day-Bed mit Himmel-Sonnenschutz und Vorhänge\_ day-bed avec baldaquin- parasol et rideaux  
Key west (cipria) art. 4266 tavolino\_ side table\_ Beistelltisch\_ table basse (aluminum top)



**Atollo** (cipria) (iride turchese)  
art. 4360 day-bed con baldacchino e vela parasole  
*art. 4360 day-bed with sun protection*  
Day-Bed mit Himmel-Sonnenschutz  
*day-bed avec baldaquin-parasol*





Atollo (cipria) (petra azzurro)  
art. 4365 day-bed\_Day-bed



listen to  
your  
wishes



**Atollo** (white)  
art. 4365 day-bed\_Day-bed



05/P

# Portofino

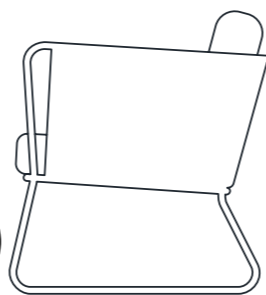

Dalla cultura del mare nasce la collezione Portofino; terra, cielo ed il blu del mare: questi i colori proposti per arredi dal gusto mediterraneo.

*The Portofino collection comes from the seafaring culture; it has the colours of the earth, of the clear sky and of the deep blue water: a true mediterranean style.*

Die Kollektion Portofino kommt von einem Seemanns-Lebenstil: hat die Farben von der Erde, vom Himmel und tiefes blaues Wasser: echtes mediterrän Styl.

*La collection Portofino a ses origines dans la culture marine: les couleurs de la terre, du ciel clair et le bleu de l'eau. Un véritable style méditerranéen.*



Portofino (terra\_nautic rope sand) (pistacchio)

art. 9770 altalena con funi\_swing whith ropes\_Hängeschaukel mit Seil\_balançoire avec cordes



Portofino (terra\_nautic rope sand) (pistacchio)  
art. 9770 altalena con funi \_swing whith ropes\_Hängeschaukel mit Seil\_balançoire avec cordes



Portofino (terra\_nautic rope sand) (onde azzurro)  
art. 9770 altalena con funi\_swing whith ropes\_Hängeschaukel mit Seil\_balançoire avec cordes

Portofino (terra\_nautic rope sand) (menta)  
art. 9770 altalena con funi\_swing whith ropes\_Hängeschaukel mit Seil\_balançoire avec cordes



just  
**breathe**



Portofino (terra\_nautic rope sand) (azzurro mare\_righe azzurro\_bianco)

art. 9768 Day-bed con baldacchino e 2 tavolini

Canopied Day-bed with sun protection and 2 side tables

Day-Bed mit Himmel-Sonnenschutz und 2 Seitentische

Day-bed avec baldaquin-parasol et 2 petites tables

Portofino (terra\_nautic rope sand)



Portofino (terra\_nautic rope sand) (petra sabbia\_petra azzurro\_onde azzurro)  
art. 9766 day-bed con 2 tavolini\_day-bed with 2 side tables\_Day-Bed mit 2 Seitentische\_day-bed avec 2 petites tables



Portofino (terra\_nautic rope sand) (petra azzurro\_onde azzurro\_petra sabbia)  
art. 9742 art. 9743 divano\_Sofa\_canapé  
art. 9746 tavolino\_coffee table\_Couchtisch\_table basse (hpl corten)







Portofino (terra\_nautic rope sand) (mosaic oromix\_kristal oromix)  
art. 9741 poltrona\_armchair\_Sessel\_fauteuil art. 9742 divano\_Sofa\_canapé  
art. 9745 tavolino\_coffee table\_Couchtisch\_table basse (hpl corten)



Portofino (terra\_nautic rope sand)  
art. 9740/B sedia con braccioli\_armchair\_Armliehnstuhl\_Chaise avec accoudoirs  
art. 9776 tavolo\_table\_Tisch (hpl corten)

Portofino (terra\_nautic rope sand)  
art. 9740\_sedia\_chair\_Stuhl\_chaise

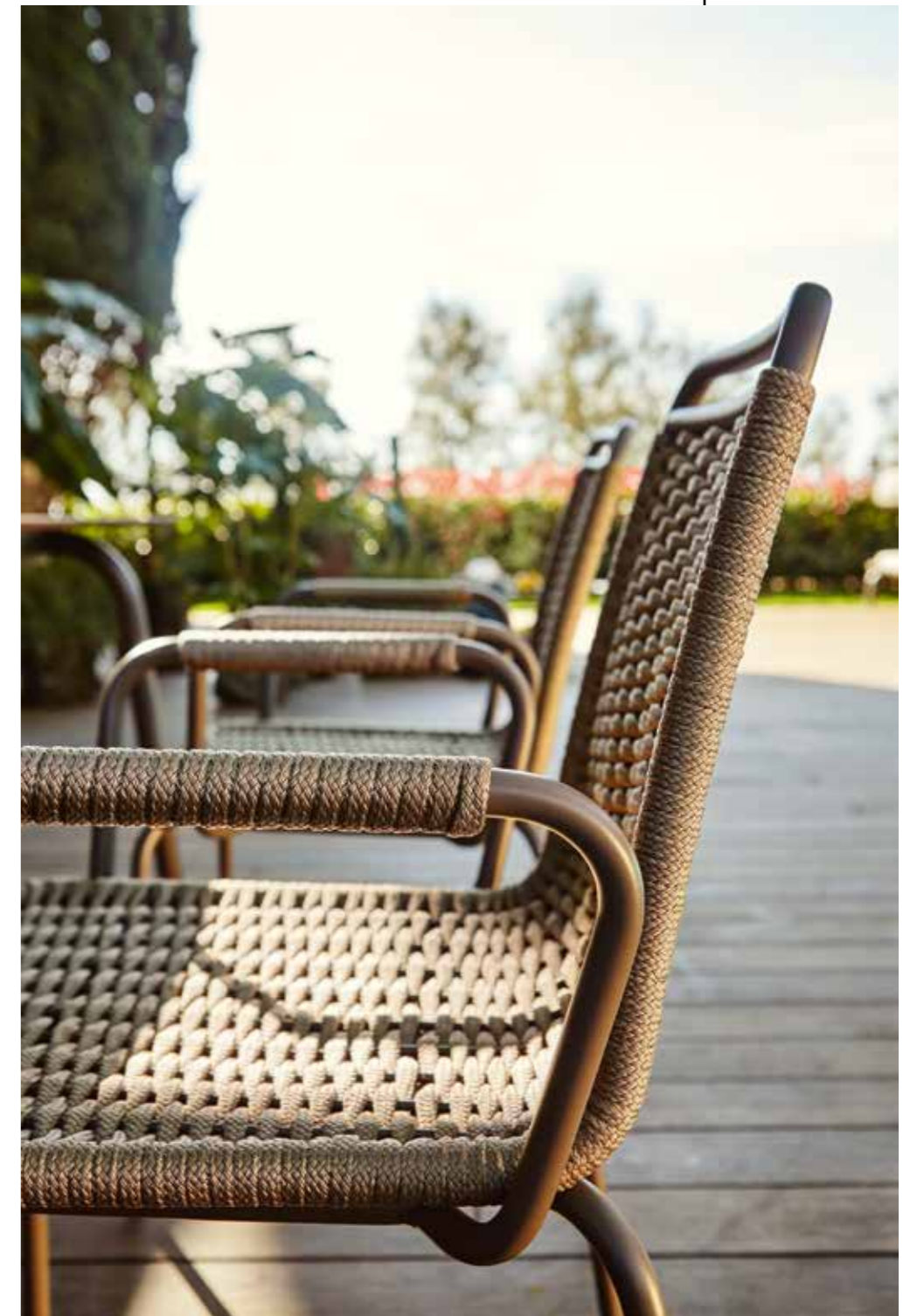

Portofino (terra\_nautic rope sand)  
art. 9740/B sedia con braccioli\_armchair\_Armliehnstuhl\_chaise avec accoudoirs



Take it

slow

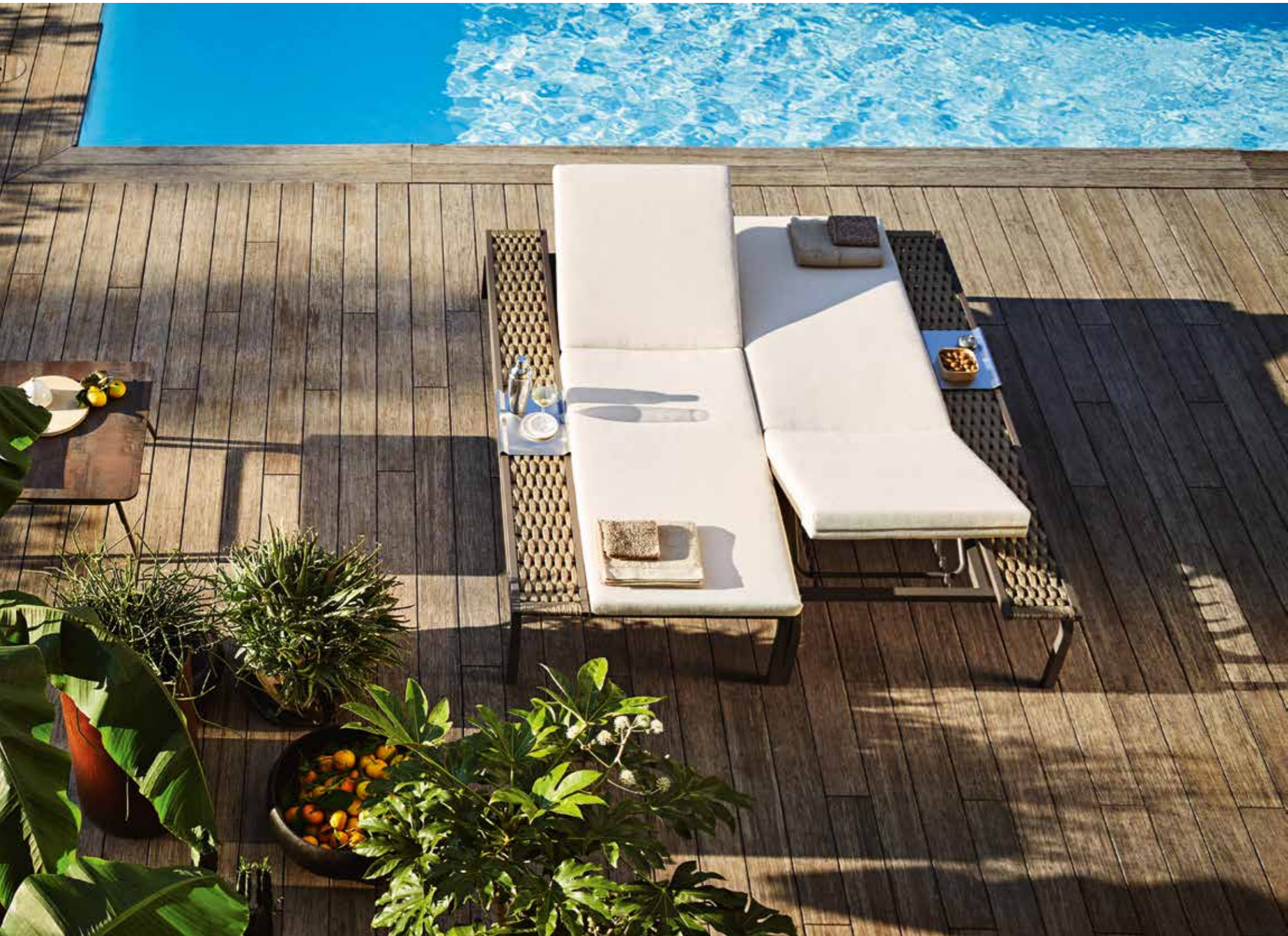

Portofino (terra\_nautic rope sand) (mosaic oromix)  
art. 9749 lettino\_sun bed\_Sonnenliege\_bain de soleil  
art. 9748 vassoio\_tray\_Tablett\_plateau

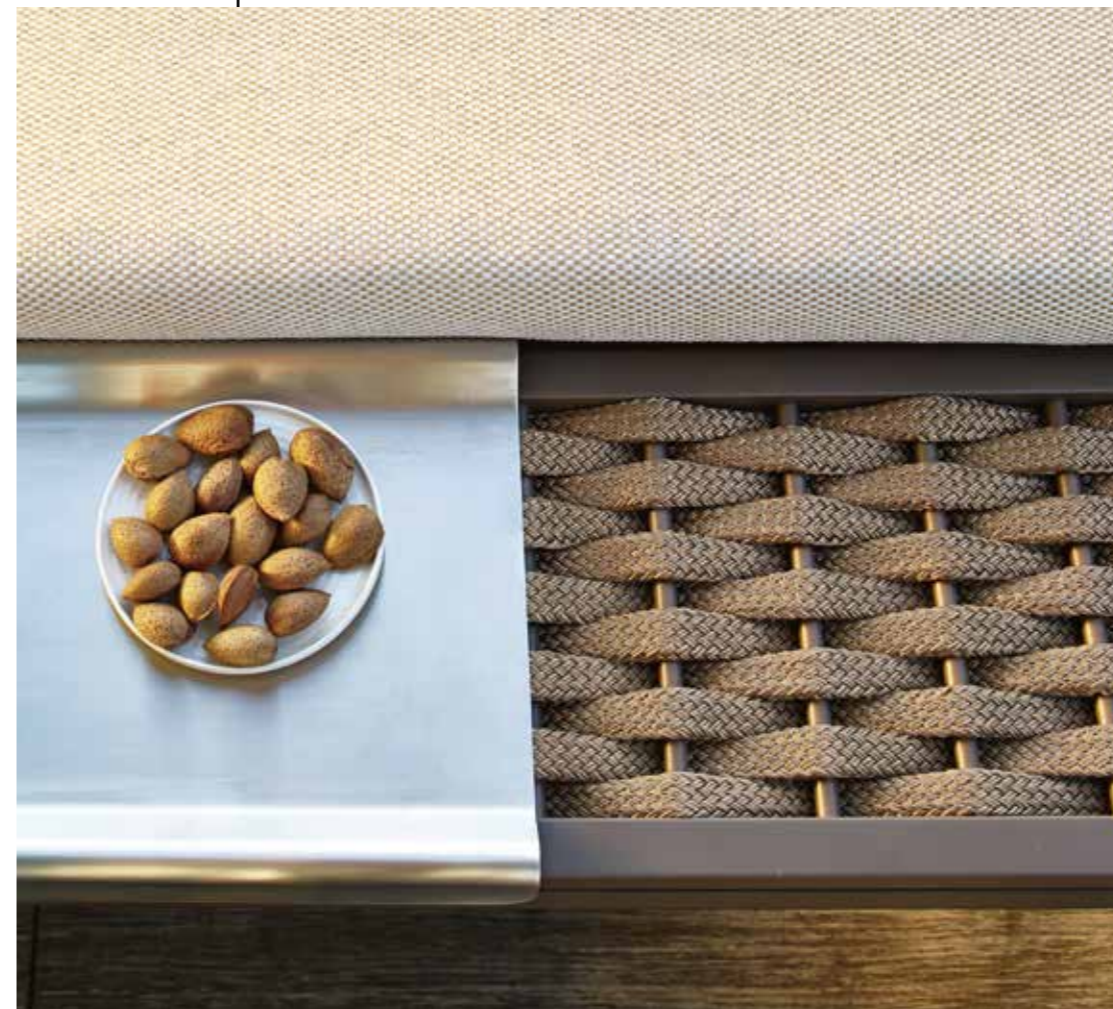

Portofino (terra)  
art. 9748 vassoio\_tray\_Tablett\_plateau  
art. 9749R lettino con ruote\_sun bed with wheels\_Sonnenliege mit Räder\_bain de soleil avec roues

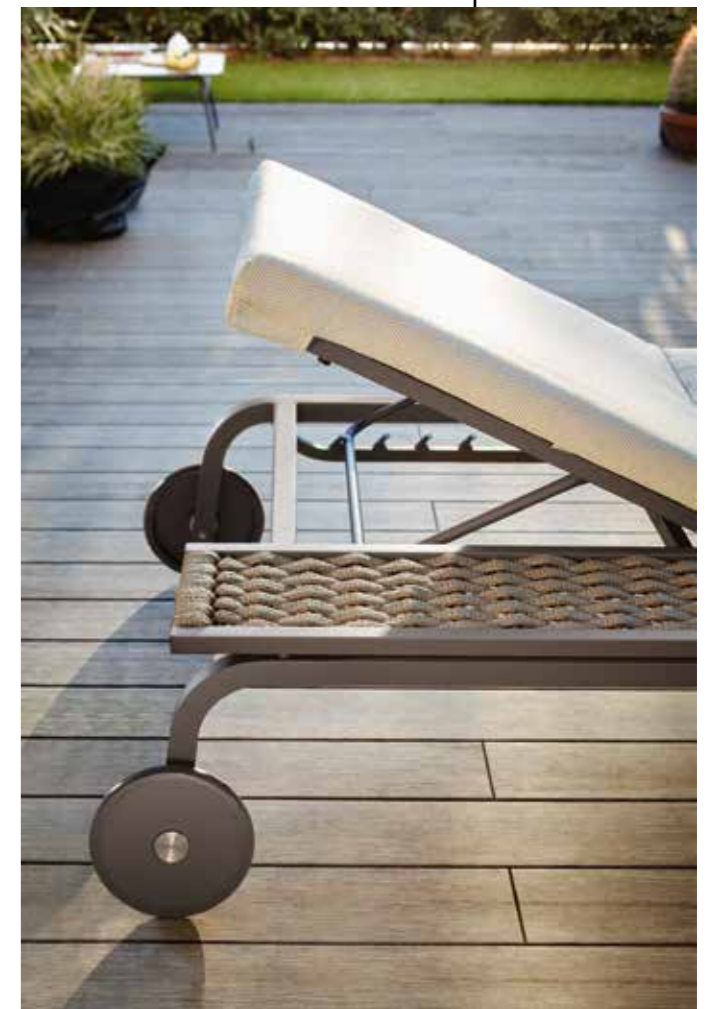



06

# Coral Reef

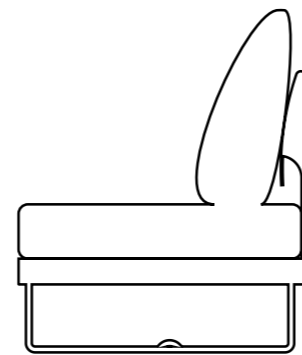

Linee morbide ed essenziali unite ad una funzionale componibilità dei divani.

*Soft, minimal shapes are performing in the function of the modular sofa.*

Klare und pure Linien geben der Funktion des modularen Sofas mehr Wert.

*Des lignes douces et pures donnent valeur à la fonction du système canapé.*

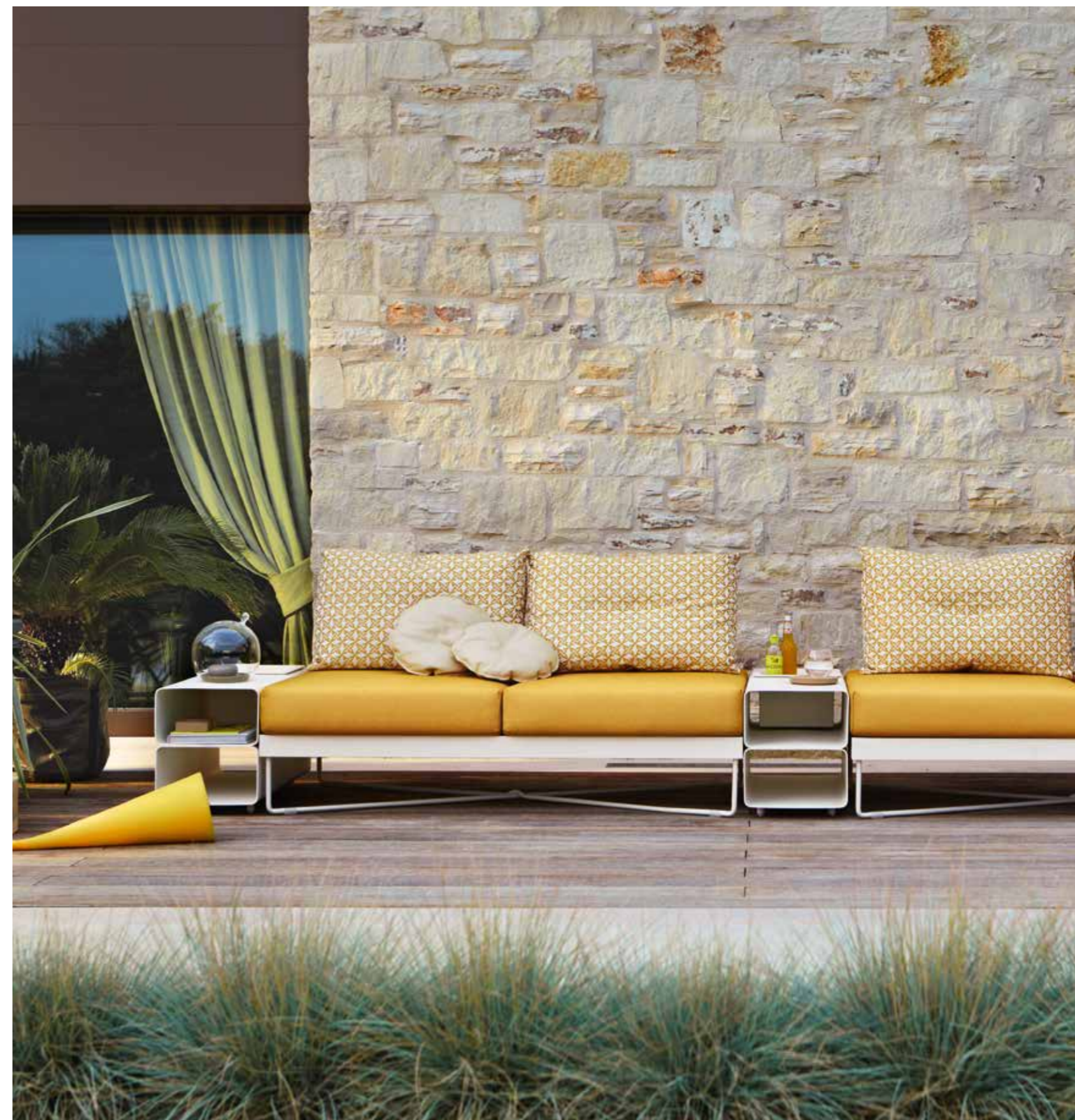

Coral Reef (white) (mosaic ocra\_kristal ocra)  
art. 9802FA elemento 2 posti\_2-seats element\_2-Sitz-Element\_élément 2 places



Coral Reef (white) (mosaic ocre\_kristal ocre)  
art. 9802FA elemento 2 posti\_2-seats element\_2-Sitz-Element\_élément 2 places  
art. 9818 tavolino\_storage table\_Kleintisch\_table de rangement



**Coral Reef** (terra\_corda) (natte fumo\_natte erica)  
art. 9841FA set composition  
art. 9852 parasole\_sunshade\_Sonnenschirm\_parasol  
art. 9850 tavolino\_coffee table\_Couchtisch\_table basse





art. 9854 (white)  
*Parasole\_sunshade\_Sonnenschirm\_parasol*

**Coral Reef** (oval sunloom terra) (natte fumo\_natte erica)  
art. 9805 lettino doppio\_double sunlounger\_Doppelliege\_bain  
de soleil double  
art. 9800 elemento laterale\_multiservice side element\_Multiservice  
Seiten-element\_élément latéral multiservice  
art. 9853 (white) parasole\_sunshade\_Sonnenschirm\_parasol





Coral Reef (oval sunloom white\_fibreglass white) art. 9860 sedia\_chair\_Stuhl\_chaise  
art. 9868F tavolo\_table\_Tisch (hpl white)

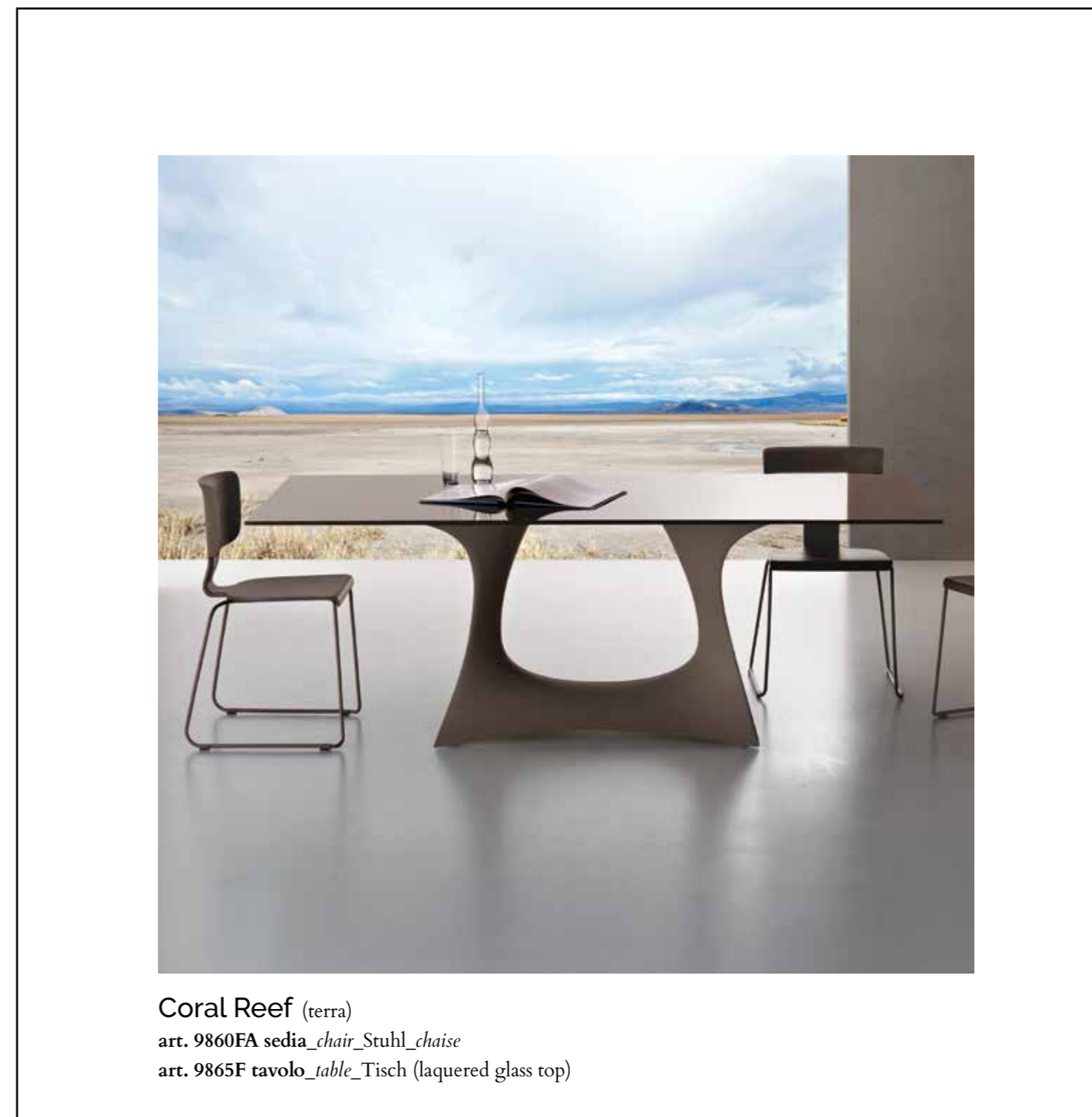

Coral Reef (terra)  
art. 9860FA sedia\_chair\_Stuhl\_chaise  
art. 9865F tavolo\_table\_Tisch (laquered glass top)



follow

the beauty

Coral Reef (fibre glass white)  
art. 9870F tavolo\_table\_Tisch (trasparent glass top)



# 07/ Hamptons Graphics

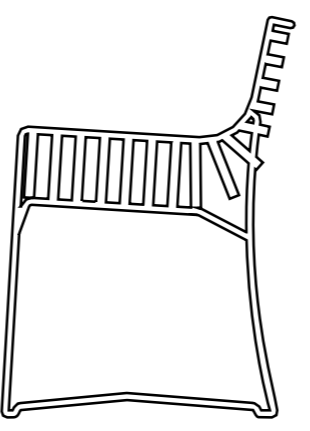

Raffinato ed originale nelle virtuose elaborazioni delle strutture.

*The skilled formulation of the lines makes the collection sophisticated and unique.*

Die raffinierte und originale Verarbeitung bietet einen überfeinerten Anschein.

*La savante élaboration des lignes des structures donne à l'ensemble un ton sophistiqué et unique.*

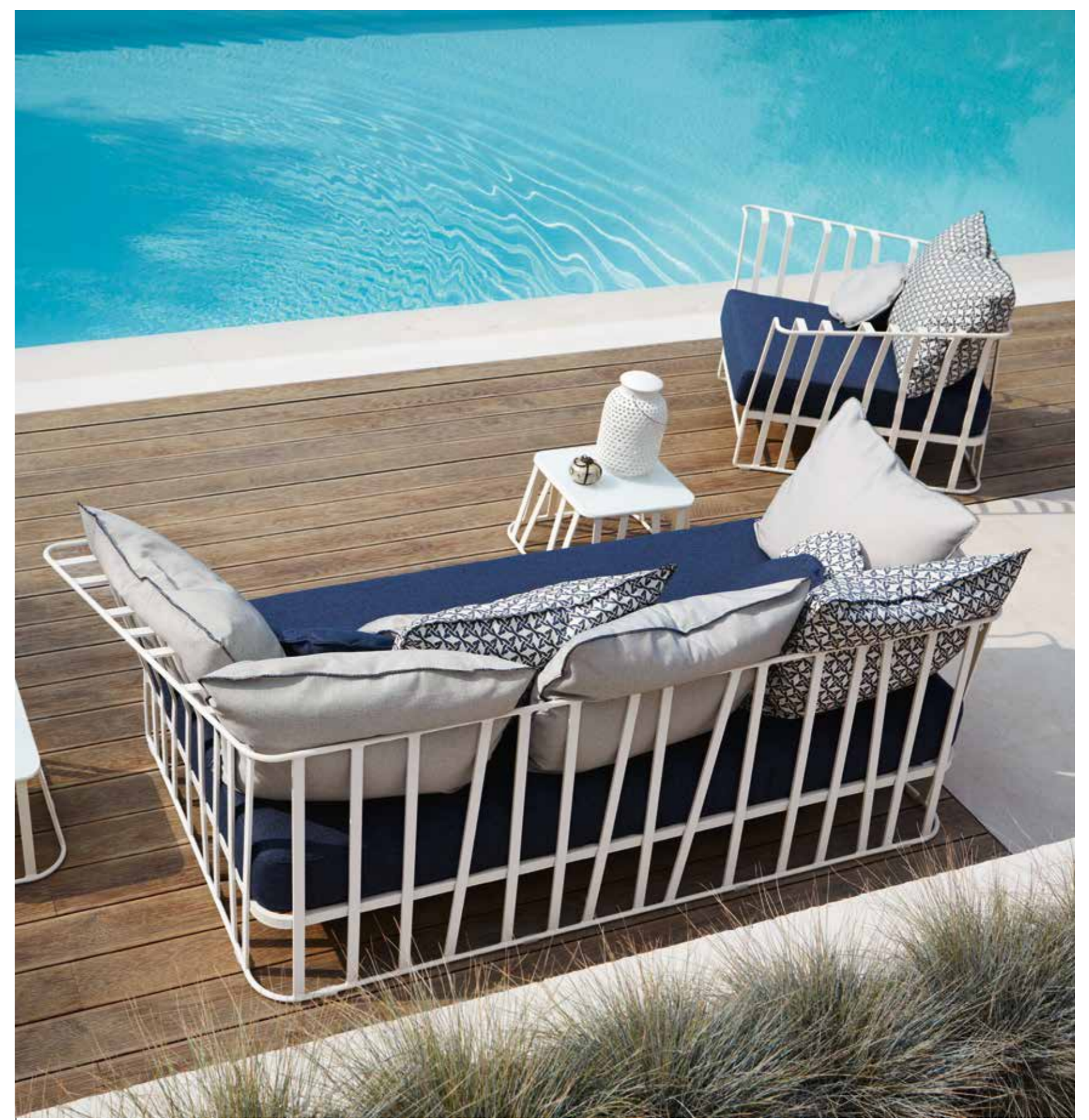

Hamptons Graphics (white) (mosaic blu\_kristal blu\_tricot blu)  
art. 9732 divano\_Sofa\_canapé



Hamptons Graphics (white) (mosaic blu\_kristal blu\_tricot blu)

art. 9732 divano\_Sofa\_canapé

art. 9731 poltrona\_armchair\_Sessel\_fauteuil

art. 9739 tavolino\_side table\_Clubtisch\_table basse (laquered glass top)

design  
your  
comfort zone



Hamptons Graphics (coffee) (brownies\_noce\_flowers)  
art. 9731 poltrona\_armchair\_Sessel\_fauteuil  
art. 9732 divano\_Sofa\_canapé  
art. 9736 tavolino\_side table\_Clubtisch\_table basse  
(laquered glass top)  
art. 9735 tavolino quadrato\_square coffee table\_Ecktisch  
\_table basse carrée (laquered glass top)



Hamptons Graphics (white\_nautic stripe taupe)  
art. 9733 poltrona\_armchair\_Sessel\_fauteuil



Hamptons Graphics (white) (nautic stripe white) art. 9734 divano\_Sofa\_canapé  
art. 9733 poltrona\_armchair\_Sessel\_fauteuil  
art. 9735H | art. 9739H tavolino\_side table\_Clubtisch\_table basse (hpl white)



Hamptons Graphics (coffee) (mosaic ocra\_ kristal ocra\_tricot ocra)

art. 9734 divano\_Sofa\_canapé

art. 9733 poltrona\_armchair\_Sessel\_fauteuil

art. 9739H tavolino\_side table\_Clubtisch\_table basse (hpl corten)



Hamptons Graphics (coffee) (nautic stripe taupe)  
art. 9751 sedia\_chair\_Stuhl\_chaise  
art. 9727 tavolo\_table\_Tisch (hpl corten)





be creative



Hamptons Graphics (white) (mosaic blu)  
art. 9750 sedia\_chair\_Stuhl\_chaise  
art. 9730 tavolo\_table\_Tisch (hpl white)

Hamptons Graphics (coffee) (nautic stripe taupe)  
art. 9751 sedia\_chair\_Stuhl\_chaise



Hamptons Graphics (white) (mosaic blu)  
art. 9750 sedia\_chair\_Stuhl\_chaise



Hamptons Graphics (sunweave bianco perla)

art. 9720 sedia\_chair\_Stuhl\_chaise

art. 9721 sedia con braccioli\_dining chair\_Armliehnstuhl\_chaise avec accoudoirs

art. 9728 tavolo\_table\_Tisch (hpl white)



Hamptons Graphics (coffee\_straps coffee) art. 9723 sedia\_chair\_Stuhl\_chaise art. 9724 sedia con braccioli\_dining chair\_Armliehnstuhl\_chaise avec accoudoirs  
art. 9725 tavolo\_table\_Tisch (laquered glass top)



## 08/ Hamptons

Semplicemente sontuoso nelle forme e nei preziosi materiali.

*Rich materials and refined forms: simply luxurious.*

Hochwertige Materialien und breite Formen: einfach prächtig.

*Matières et formes très riches: tout simplement somptueux.*



Hamptons (sunweave perla) (natte azzurro)  
art. 9619 divano\_Sofa\_canapé



Hamptons (sunweave bianco perla) (natte bianco\_sand\_petra azzurro\_mosaic blu)  
art. 9620 divano\_corner sofa\_Rundeck Sofa\_canapé d'angle  
art. 9607 tavolino\_coffee table\_Couchtisch\_table basse

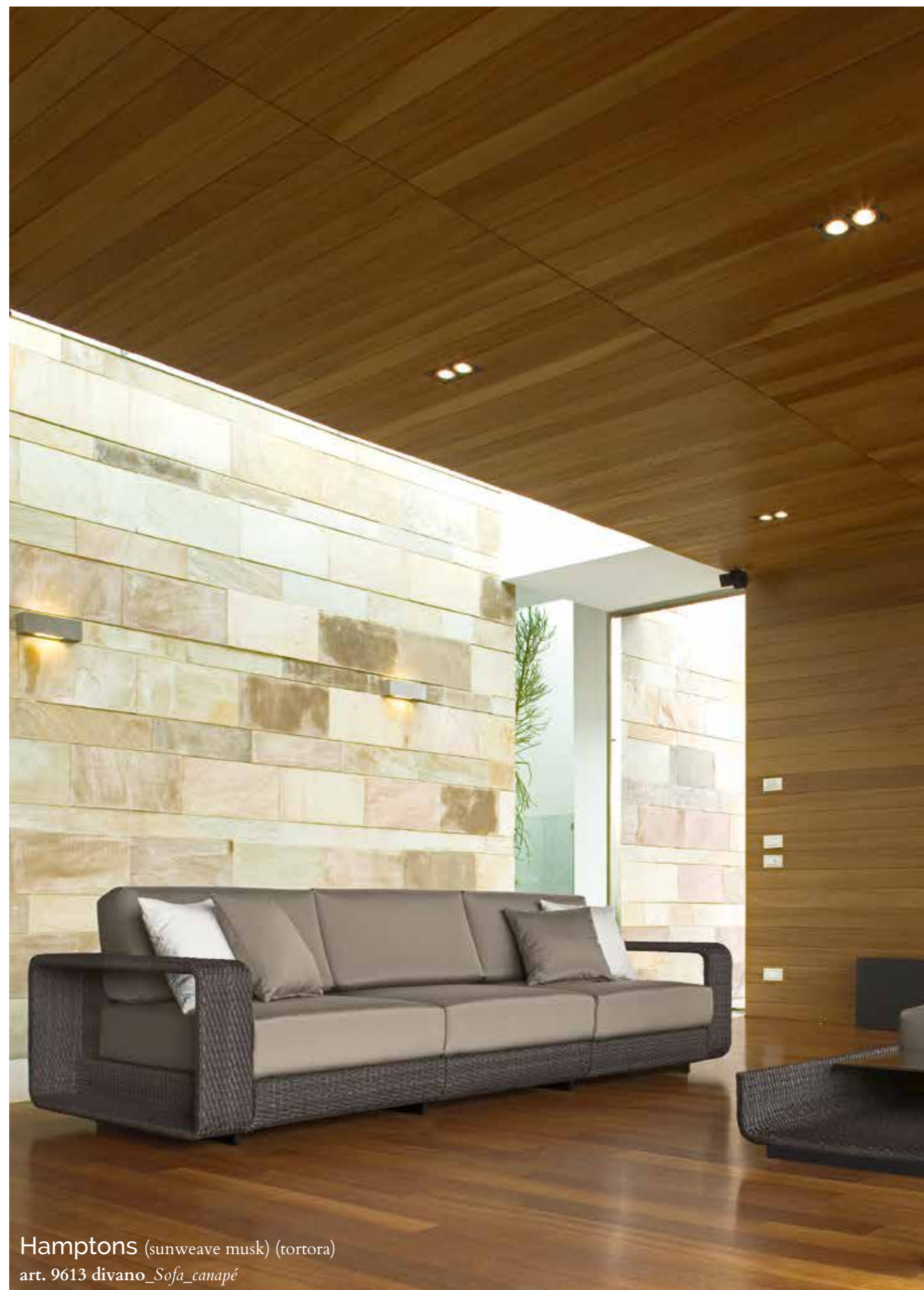

Hamptons (sunweave musk) (tortora)  
art. 9613 divano\_Sofa\_canapé



Hamptons (sunweave musk\_tortora\_mosaic ocra)  
art. 9616 divano ad angolo\_corner sofa\_Rundeck Sofa\_canapé d'angle  
art. 9607 tavolino\_coffee table\_Couchtisch\_table basse  
art. 9608 pouf\_Hocker



fill  
up  
with **light**

Hamptons (sunweave bianco perla\_musk)  
art. 9625 poltrona\_armchair\_Sessel\_fauteuil  
art. 9626 pouf\_Hocker



# 09/Caribe

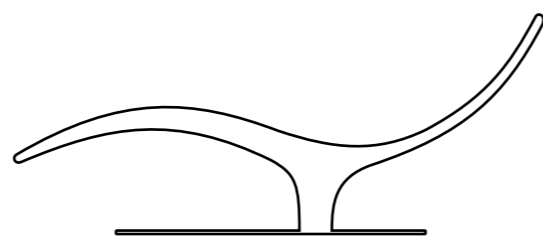

Una chaiselongue con un design inimitabile.

*A chaise longue with an incomparable design.*

Eine Chaiselongue mit einem unvergleichlichem Design.

*La chaise longue au design inimitable*



Caribe (sunloom chocolate)  
art. 9578 chaise longue





Take **care**  
of your  
**body**



10/ St

# Tropez

Morbide forme e assoluto comfort per un'eleganza senza tempo.

*Smooth lines joined to absolut comfort for a timeless elegance.*

Weiche Linien und sicherer Komfort für eine Zeitlose Eleganz.

*Des formes arrondies et un grand confort pour une élégance qui reste inaltérable dans le temps.*

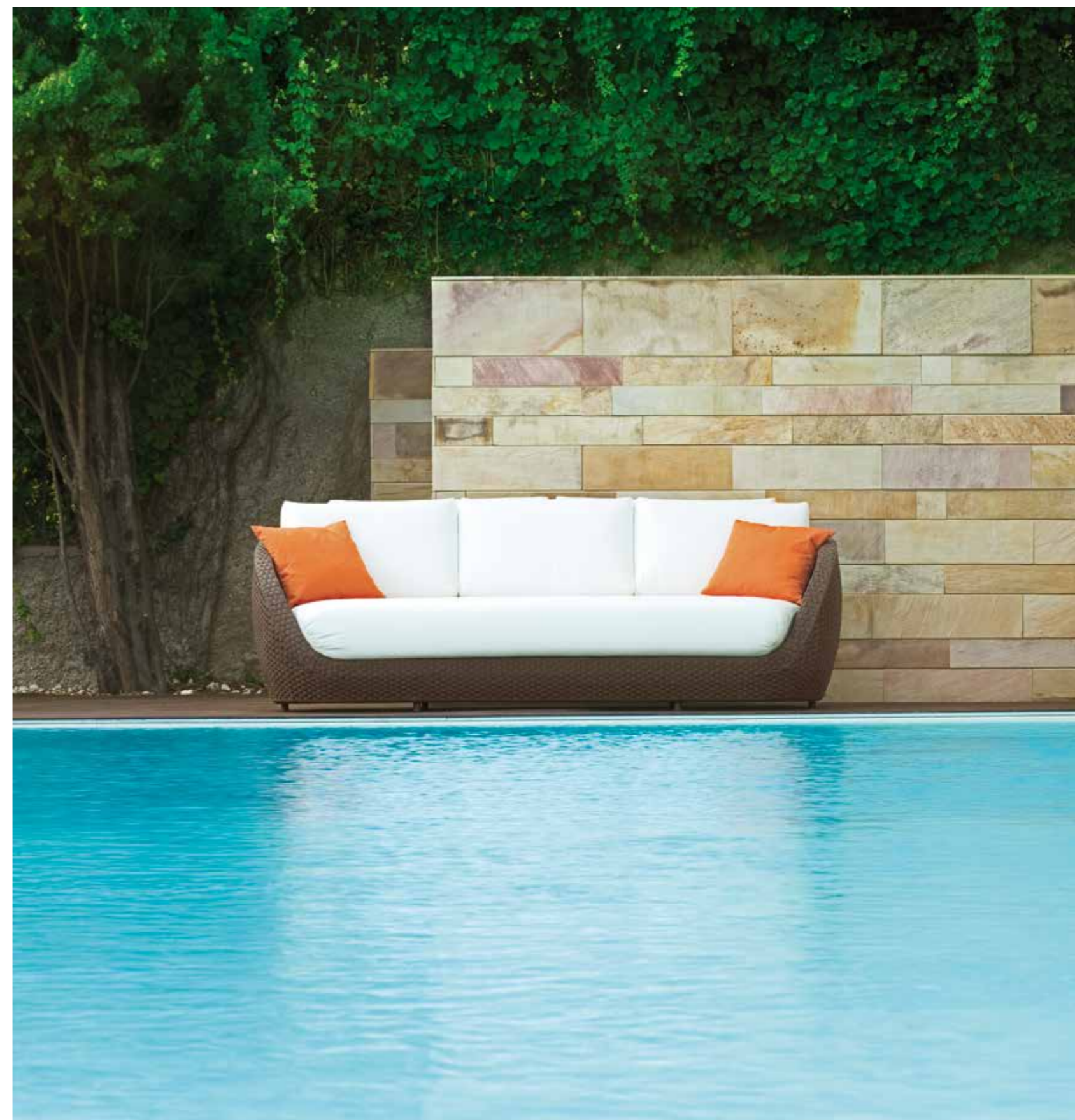

St. Tropez (sunloom chocolate)  
art. 9579 divano\_Sofa\_canapè



St. Tropez (sunloom chocolate) (bianco)  
art. 9568 lettino parasole\_sun bed white sun protection\_Sonnenliege mit Sonnensegel\_bain de soleil avec toile parasol



St. Tropez (sunloom chocolate) (noce\_bianco)  
art. 9575 poltrona\_armchair\_Sessel\_fauteuil  
art. 9557 tavolino\_coffee table\_Couchtisch\_table basse (laquered glass top)



St.Tropez (sunloom chocolate)  
 art. 9541 poltroncina\_dining armchair\_Armliehnstuhl\_chaise avec accoudoirs  
 art. 9544 tavolo\_table\_Tisch



St.Tropez (sunloom chocolate)  
 art. 9541 poltroncina\_dining armchair\_Armliehnstuhl\_chaise avec accoudoirs  
 art. 9542 tavolo\_table\_Tisch (laquered glass top)  
 art. 9543 poltrona\_armchair\_Sessel\_fauteuil





11/

# Igloo

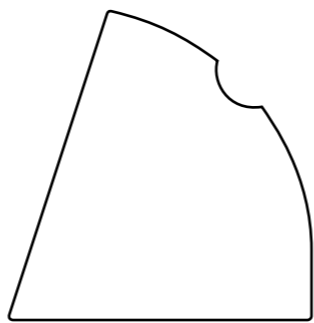

Un originale day-bed per un fresco riposo.

*Originality for this outstanding piece offering a cool relaxation.*

Das Day-Bed Sofa mit einem originellem Design bietet eine kühle Entspannung.

*Le Day-bed avec son design original offre un coin frais pour se relaxer.*



igloo (sunweave bianco perla) (bianco\_natte azzurro) art. 9631 divano\_sun nest  
art. 9634 tavolino\_coffee table\_Couchtisch\_table basse (laquered glass top)



Igloo (sunweave bianco perla)  
art. 9631 divano\_sun nest



# 12/Samba Rio

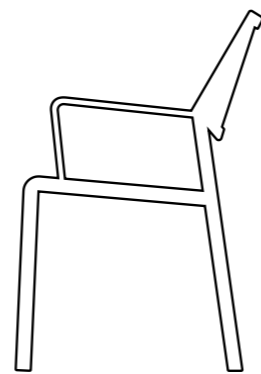

Modelli essenziali ed eleganti, con forme equilibrate e funzionali.

*Functional and elegant models with minimal design and high comfort.*

Modelle mit einfachem, elegantem Design und hohem Komfort.

*Des modèles avec des lignes sobres et élégantes pour un grand confort.*



Samba Rio (terra)  
art. 9744/B tavolo allungabile\_table white extendible top\_Tisch mit ausziehbarer Platte\_table avec dessus à rallonge (aluminum top)  
art. 9760 sedia con braccioli\_armchair\_Armehnstuhl\_chaise avec accoudoirs

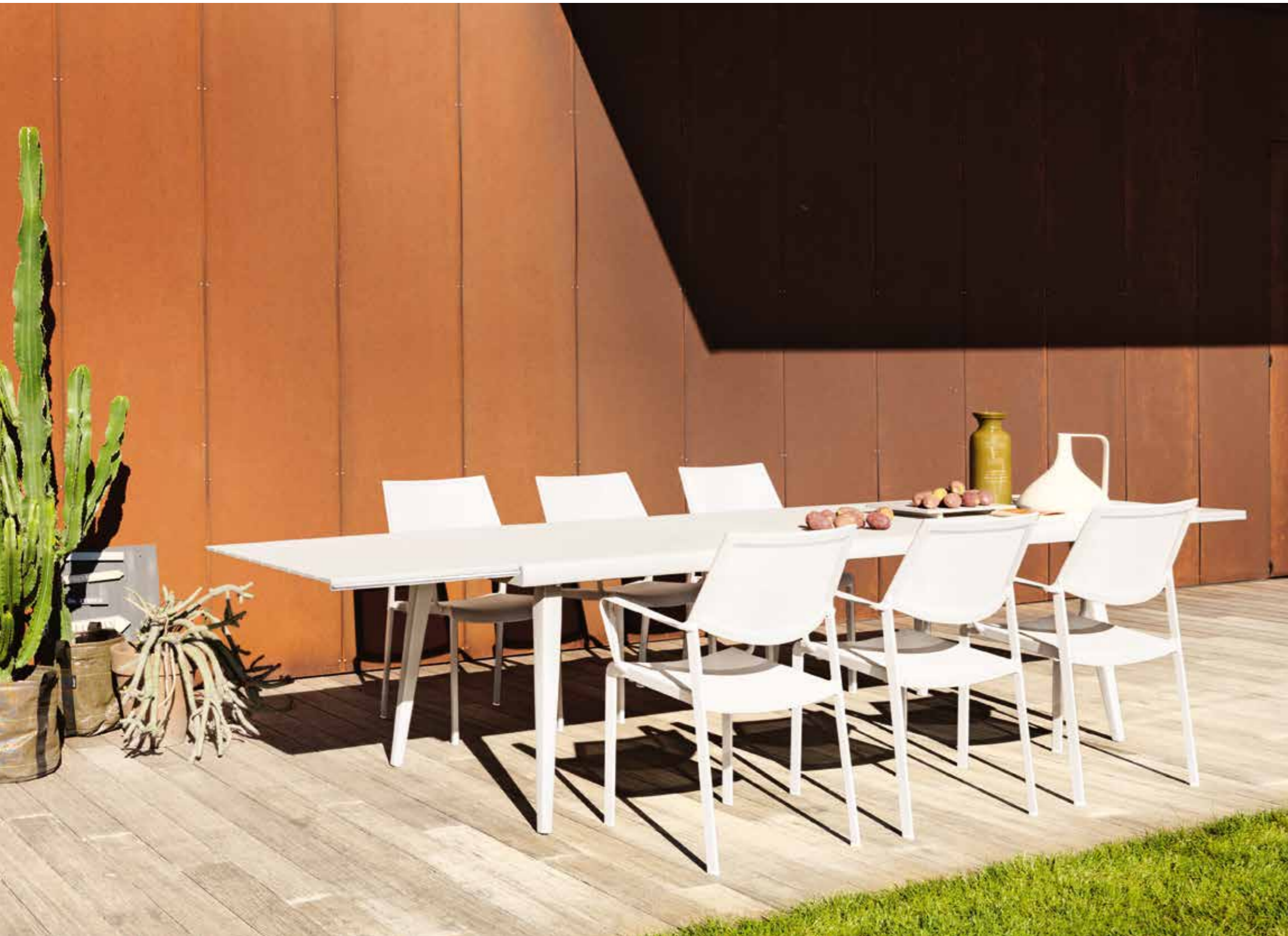

**Samba Rio** (white)

art. 9760 sedia con braccioli\_armchair\_Armliehnstuhl\_chaise avec accoudoirs

art. 9744 tavolo allungabile\_table white extendible top\_Eßtisch mit ausziehbarer Platte\_table avec dessus à rallonge (aluminum top)



**Samba Rio** (terra)

art. 9760 sedia con braccioli\_armchair\_Armliehnstuhl\_chaise avec accoudoirs

art. 9744 tavolo allungabile\_table white extendible top\_Tisch mit ausziehbarer Platte\_table avec dessus à rallonge (aluminum top)







Samba Rio (white) art. 9761 sedia\_chair\_Stuhl\_chaise  
art. 9774 base tavolo\_table base\_Tischgestell\_base table  
art. 9689 piano\_top\_Tischplatte\_plateau (hpl white)





Samba Rio (white)  
 art. 9761 sedia\_chair\_Stuhl\_chaise  
 art. 9773 base tavolo\_table base\_Tischgestell\_base table  
 art. 9686 piano\_top\_Tischplatte\_plateau (hpl white)



art. 9760 sedia con braccioli\_armchair  
 Armlehnstuhl\_chaise avec accoudoirs



Samba Rio (terra)  
 art. 9761 sedia\_chair\_Stuhl\_chaise  
 art. 9773 base tavolo\_table base\_Tischgestell\_base table  
 art. 9682 piano\_top\_Tischplatte\_plateau (hpl white)

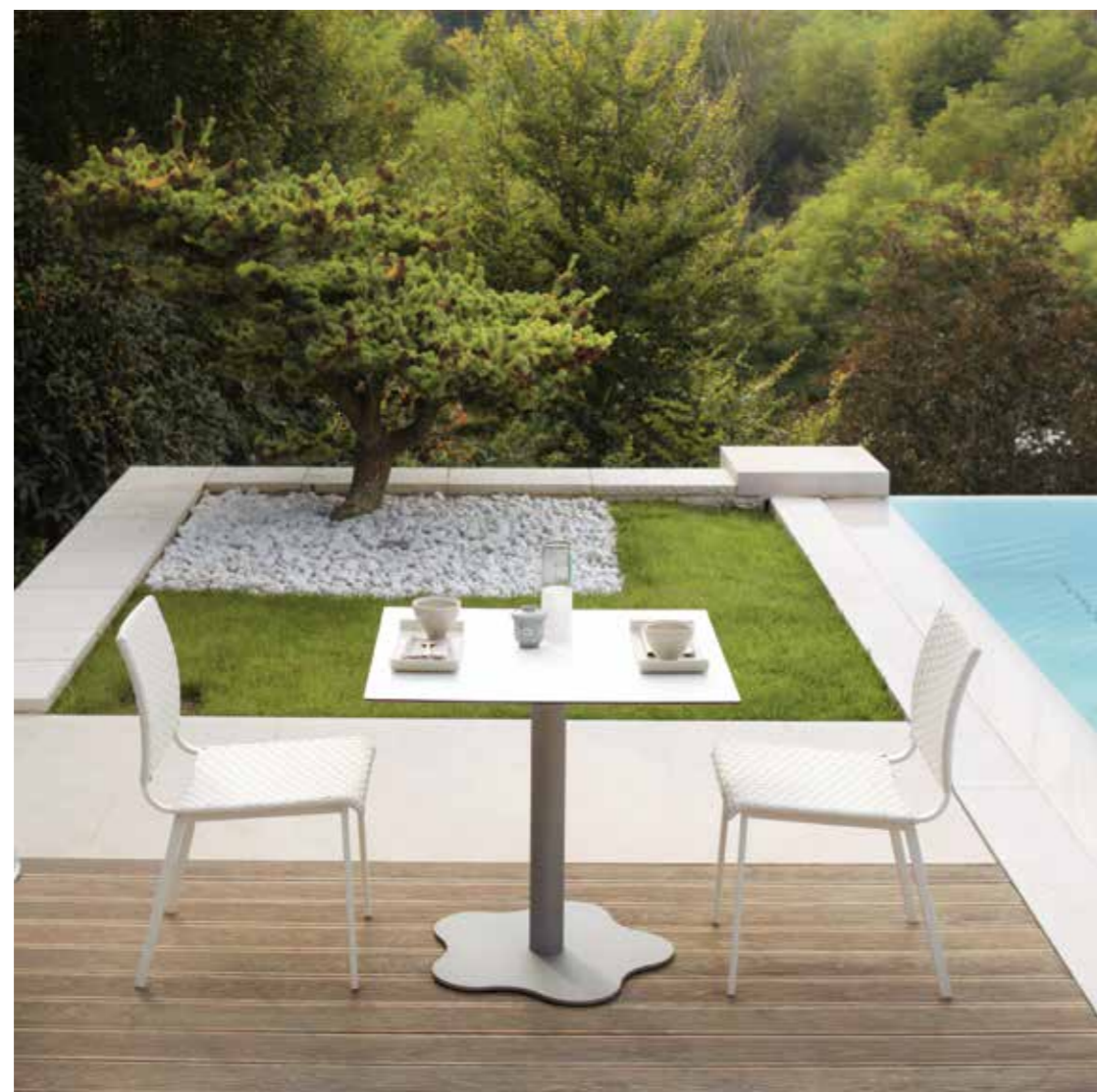

Samba Rio (aluminum)  
 art. 9586 base tavolo\_table base\_Tischgestell\_base table  
 art. 9686 piano\_top\_Tischplatte\_plateau (hpl white)  
 Hamptons Graphics (white) (sunweave white) art. 9720 sedia\_chair\_Stuhl\_chaise



Samba Rio (aluminum) art. 9586 base tavolo\_table base\_Tischgestell\_base table art. 9687 piano\_top\_Tischplatte\_plateau (hpl white)  
 Hamptons Graphics (white) (sunweave white) art. 9720 sedia\_chair\_Stuhl\_chaise



Samba Rio (white)  
art. 9762 poltrona lounge\_lounge armchair\_lounge Sessel\_fauteuil lounge  
art. 9763 pouf\_Hocker

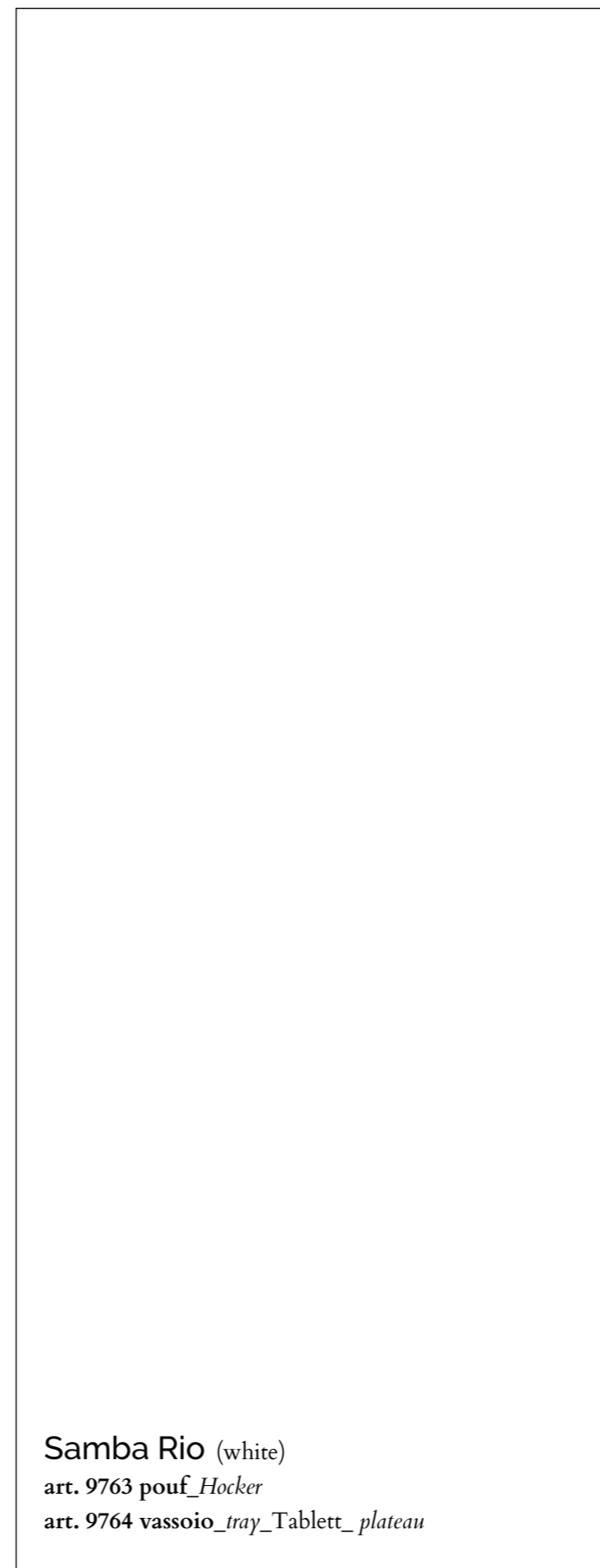

Samba Rio (white)  
art. 9763 pouf\_Hocker  
art. 9764 vassoio\_tray\_Tablett\_plateau



live  
**here**  
and  
now



Samba Rio (white\_terra) (petra panna)  
art. 9900A lettino\_sun bed\_Sonnenliege\_bain de soleil  
art. 9901 tavolino\_side table\_Beistelltisch\_table basse  
(aluminum top)

# Technical Data Materials

Tutte le strutture sono realizzate in alluminio e/o acciaio con finitura a polveri a garanzia di leggerezza, durata e resistenza agli agenti atmosferici. Per gli intrecci si utilizzano il Sunweave (fili di polietilene) ed il Sunloom (fili di poliestere rivestiti in PVC); Sunweave e Sunloom sono filamenti testati SGS.

La collezione Portofino ha parti intrecciate con Nautic Rope (corda nautica), una corda in poliestere, robusta e resistente all'acqua ed alla salsedine. Il nuovo Searope, corda in polipropilene di ultima generazione, abbina la bellezza di un tocco naturale ad una forte robustezza, resistenza all'acqua e ai raggi UV.

Sunweave, Sunloom, Nautic Rope e SeaRope sono resistenti al caldo, al freddo, all'acqua salata ed ai raggi UV.

Nelle collezioni Lipari, Key West, Portofino e Samba Rio è previsto l'utilizzo di Batyline (originale Serge Ferrari) e Textilene.

Quegli sono tessuti in PVC con piccole forature che permettono areazione e drenaggio dell'acqua. Il batyline ed il textilene sono resistenti al caldo, al freddo e all'acqua salata.

I piani dei tavoli possono essere in vetro laccato o trasparente temperato, alluminio oppure in HPL (high pressure laminate) adatto per esterni.

La manutenzione di tutti i mobili è oltremodo semplice: lavare sia le strutture che le parti intrecciate con acqua fredda e sapone neutro aiutandosi con una spazzola a setole morbide e una spugna. Sciacquare con acqua fredda e far asciugare bene all'aria.

Non usare detergenti aggressivi o prodotti al cloro. Per maggiori dettagli si raccomanda la lettura del cartellino 'manutenzione' che viene fornito alla consegna dei mobili.

La durata dei mobili è subordinata ad un corretto utilizzo e ad una adeguata manutenzione come da noi suggerito. Si declina ogni responsabilità per danni a persone o cose causati da uso improprio ed atti vandalici.

Roberti si riserva la facoltà di apportare modifiche o migliorie senza alcun preavviso.

*All structures are in aluminum and/or stainless steel powder coated to ensure lightness, durability and resistance to atmospheric agents.*

*Sunweave (polyethylene fibres) and Sunloom (polyester fibre coated PVC) are used for weaving some furniture parts. Sunweave and Sunloom are both SGS tested materials.*

*The Portofino collection has parts woven with Nautic Rope, a robust and water resistant polyester rope.*

*The new Searope, a rope made of last generation of polypropylene, combines the beauty of a natural touch to a good resistance to water and UV rays.*

*Sunweave, Sunloom, Nautic Rope and Sea Rope withstand heat, cold, water and sea spray as well as ultraviolet rays.*

*In the collections Lipari, Key West, Portofino and Samba Rio we use the Batyline (original by Serge Ferrari) and Textilene. Both materials are in PVC with open structure allowing aeration and water drainage. Batyline and Textilene are resistant to the heat, cold and salt water.*

*Table tops may be either in tempered glass or in aluminum, or in HPL ( high pressure laminate ) suitable for outdoor use.*

*The maintenance of all furniture is very easy; just wash it with cold water and neutral soap, using a soft brush and a sponge if necessary, then rinse with cold water and let it air dry.*

*Do not use aggressive detergents or chlorine. For more detailed instructions please carefully read and follow our care and maintenance' leaflet joined to the furniture on delivery.*

*The durability of each single furniture piece is subject to proper use; we deny any responsibility for damages caused by improper use or vandalism.*

*Roberti has the right to modify or upgrade the product without prior notice.*

Alle Möbel-Gestelle sind aus Aluminium und/oder Edelstahl pulverbeschichtet die Leichtigkeit, Widerstandsfähigkeit gegen Witterungseinflüsse und Langlebigkeit garantieren. Für die geflochtene Teile werden Sunweave (Polyethilene Faser) und Sunloom (Polyester Faser beschichtet mit PVC) verwendet. Sunweave und Sunloom sind SGS getestet.

Die Kollektion Portofino hat Teile die mit Nautic Rope geflochten sind.

Nautic Rope ist ein Seil aus Polyester, fest und gleichzeitig weich.

Das schöne neue SEAROPE, Polypropylenseil, ist ein neuer Vorschlag mit einer natürlichen Note, doch ist robust, Wasser- und UV-Strahlen beständig.

Sunweave, Sunloom, Nautic Rope und Searope sind beständig gegen Hitze, und Kälte Wasser und Salzurückstände wie auch gegen UV-Strahlen.

Das Batyline ( original Serge Ferrari ) und das Textilene werden in den Kollektionen Lipari, Key West, Portofino und Samba Rio verwendet.

Diese Gewebe sind aus PVC und erlauben eine gute Belüftung und lassen das Wasser ablaufen. Batyline und Textilene sind Hitze- und Kälte beständig, aber auch gegen Salzwasser.

Die Tischplatten sind, aus lackiertem und gehärtetem Glas, oder Aluminium, oder aus HPL ( High Pressure Laminate ) geeignet für den Außenbereich.

Die Langlebigkeit der Möbel ist mit einer ordentlichen Verwendung verbunden; die Pflege ist leicht: einfach die Möbelteile mit Wasser und neutraler Seife reinigen, evtl. mit der Hilfe einer weichen Bürste, dann mit kaltem Wasser abspülen und trocknen lassen. Die Verwendung von aggressiven Reinigungsmitteln und Chlor sind absolut zu vermeiden.

Wir bitten, die auf unseren 'Care and maintenance' Brochüre angegebene Empfehlungen, aufmerksam zu folgen. Die Brochüre wird mit den Möbel geliefert. Die Langlebigkeit der Möbel ist mit einer ordentlichen Verwendung verbunden. Wir lehnen jegliche Verantwortung für missbräuchliche Verwendung ab.

Roberti behält sich das Recht vor, ohne jegliche Benachrichtigung, Änderungen oder Produktverbesserungen vorzunehmen.

*Toutes les structures sont en aluminium et/ou en acier inoxydable traités avec une finition spéciale pour extérieur qui garantie résistance aux agents atmosphériques ainsi que durabilité.*

*Pour les parties tressées on utilise le Sunweave (fil de polyéthylène) et le Sunloom (fil de polyester avec revêtement en PVC); Sunweave et Sunloom sont testés SGS.*

*La collection Portofino a le tressage en Nautic Rope, un fil de polyester très robuste et flexible, avec une forte résistance aux intempéries.*

*Le nouveau tressage SEAROPE, une corde en polypropylène de nouvelle génération conjugue la beauté d'une touche naturelle et une très bonne résistance à l'eau et aux rayons UV.*

*Sunweave, Sunloom, Nautic Rope et Searope sont résistantes à la chaleur et au froid, à l'eau et à la salure ainsi que aux rayons UV.*

*Dans les collections Lipari, Key West, Portofino et Samba Rio on utilise Batyline (originale by Serge Ferrari) et Textilene.*

*Ces tissus en pvc sont ajourés, permettant l'aération et le drainage de l'eau. Batyline et Textilene sont résistants à la chaleur, au froid et à l'eau de mer.*

*Les dessus des tables sont disponibles, en verre lacqué et trempé ou en aluminium, ou en HPL (High Pressure Laminate) adapté pour l'extérieur.*

*La durée des meubles est liée à une utilisation correcte. L'entretien est très simple: il faut laver les meubles avec de l'eau froide et savon neutre en utilisant une brosse souple.*

*Après rincer et faire essuyer à l'air. Il faut absolument éviter l'utilisation de détergents agressifs ou du chlore. Nous conseillons de lire et suivre les instructions indiqués dans la brochure 'care and maintenance' que nous attachons aux meubles au moment de la livraison.*

*La durée des meubles est donc en rapport à un usage et un soin correct: nous déclinons toute responsabilité pour des dégats provoqués par une mauvaise utilisation ou actes de vandalisme.*

*Roberti se réserve la faculté d'apporter des modifications ou améliorations aux produits sans aucun préavis.*

# materials

## Finiture

*finishes\_Färbungen\_finitions*



### White

*Atollo\_Capri\_Coral Reef\_Lipari\_Hamptons Graphics\_Samba Rio Collections*

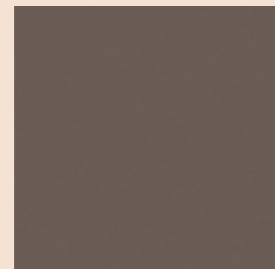

### Terra

*Coral Reef\_Portofino\_Samba Rio Collections*



### Coffee

*Hamptons Graphics Collection*



### Champagne

*Gravity Collection*



### Graphite

*Capri\_Lipari\_Gravity Samba Rio Collections*

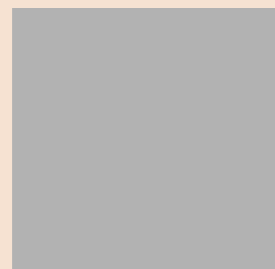

### Aluminum RAL 9006

*Samba Rio collection*

## Piani in hpl

*hpl tops\_Hpl-Platten\_plateaux en hpl*

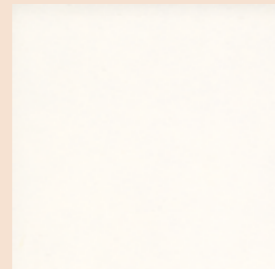

### Hpl White

*Coral Reef\_Hamptons Graphics\_Samba Rio Collections*



### Hpl Corten

*Coral Reef\_Hamptons Graphics\_Portofino\_Samba Rio Collections*



### Hpl Marble White

*Capri\_Lipari\_Samba Rio Collections*



### Hpl Slate Stone

*Capri (excluded top 130-150) Lipari\_Samba Rio Collections*



### Hpl Light Slate

*Capri collection only for top ø130/150 cm*



### Hpl Stone Grey

*Key West\_Samba Rio Collections*



### Hpl Stone White

*Key West\_Samba Rio Collections*

## Corde

*ropes\_Seile\_cordes*



### Round Searope Pearl

*Capri Collection 100% PP Imo tested*



### Round Searope Dark Grey

*Capri Collection 100% PP Imo tested*

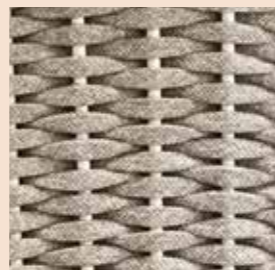

### Oval Searope Pearl

*Lipari Collection 100% PP Imo tested*

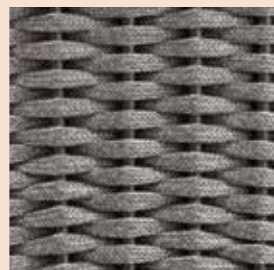

### Oval Searope Silver

*Lipari Collection 100% PP Imo tested*



### Nautic Rope Sand

*Portofino Collection 100% polyesther*



### Nautic Rope Sand

*Gravity collection 100% polyesther*



### Nautic Rope Black

*Gravity collection 100% polyesther*

## Intrecci

*weaving\_Geflechte\_tressage*



### Sunweave Bianco Perla

*Hamptons\_Hamptons Graphics Collections polyethylene*



### Sunweave Bianco Perla

*Igloo Collection polyethylene*

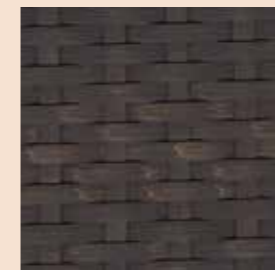

### Sunweave Musk

*Hamptons Collection polyethylene*



### Sunloom Chocolate

*Caribe\_Saint Tropez Collections polyesther-pvc*



### Oval Sunloom White

*Coral Reef Collection polyesther-pvc*

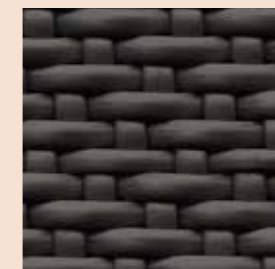

### Oval Sunloom Terra

*Coral Reef Collection polyesther-pvc*



### Straps Coffee

*Hamptons Graphics Collection*

## Batylene



### Batylene Bianco

*Samba Rio Collection (only sunbed) polyesther-pvc (Imo on request)*

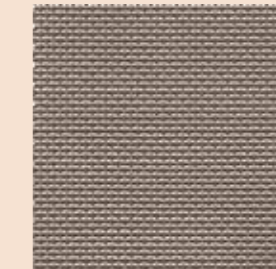

### Batylene Terra

*Portofino\_Samba Rio Collections (only sunbed) polyesther-pvc (Imo on request)*

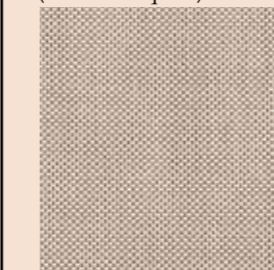

### Batylene Walnut

*Lipari Collection polyesther-pvc Imo tested*

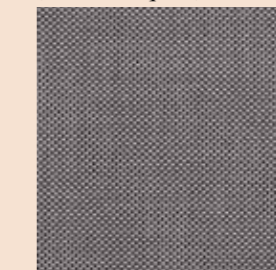

### Batylene Pepper

*Lipari Collection polyesther-pvc Imo tested*

## Textilene

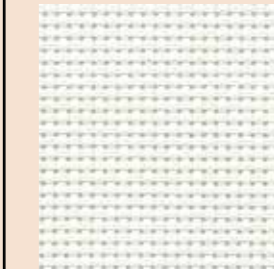

### Textilene White

*Samba Rio Collection (only chairs and pouf) polyesther-pvc*



### Textilene Terra

*Samba Rio Collection (only chairs and pouf) polyesther-pvc*

• Finitura disponibile solo in alcuni articoli della collezione, come indicato a pag. 192  
*finish only available for some articles of collection, as indicated on page 192*  
 Ausführung nur für einige Artikel der Kollektion verfügbar, wie auf Seite 192 angegeben  
*Finition disponible uniquement pour certains articles de la collection, comme indiqué à la page 192*

# Fabrics & Covers

## TESSUTI

Roberti propone una vasta gamma di tessuti adatti all'uso esterno con caratteristiche diverse. Tutti hanno un'alta resistenza ai raggi UV. Sono compresi in 3 categorie di prezzo.

**GRUPPO A1** offre una vasta gamma di tessuti adatti ad uso esterno, acrilici (Sunbrella) ed in polipropilene abbinati a imbottiture in poliuretano espanso con uno speciale rivestimento in tela poliestere idrorepellente. I cuscini morbidi degli schienali ed i piccoli cuscini decorativi contengono un mix di chips di poliestere racchiusi in una federa in poliestere - pvc idrorepellente. E' questa la proposta ideale per un cuscino per esterno ove si unisce il comfort di un tessuto alla garanzia di protezione dell'imbottitura.

**GRUPPO B1** I tessuti della categoria B1 sono composti da pvc, poliestere e poliuretano; sono tessuti idrorepellenti. I tessuti B1 abbinati alle imbottiture in poliuretano espanso con speciale rivestimento in tela di poliestere - pvc offrono quindi una quasi totale impermeabilità all'acqua. Vi possono essere piccole infiltrazioni di acqua attraverso le cuciture e quindi per garantire una veloce asciugatura all'interno si raccomanda di aprire le cerniere ed arieggiare l'interno del cuscino regolarmente. I tessuti del Gruppo B1 sono disponibili solo per alcuni modelli della collezione come specificato nel listino prezzi.

**GRUPPO C1** I tessuti della categoria C1 sono composti da pvc, poliestere e poliuretano; hanno una leggera imbottitura in poliestere fissata con termosaldatura a righe orizzontali e sono idrorepellenti. I tessuti C1 abbinati alle imbottiture in poliuretano espanso con speciale rivestimento in tela di poliestere - pvc offrono quindi una quasi totale impermeabilità all'acqua. Vi possono essere piccole infiltrazioni di acqua attraverso le cuciture e quindi per garantire una veloce asciugatura all'interno si raccomanda di aprire le cerniere ed arieggiare l'interno del cuscino regolarmente. I tessuti del Gruppo C1 sono disponibili solo per alcuni modelli della collezione come specificato nel listino prezzi.

I tessuti della categoria A1 possono essere lavati a mano, in acqua fredda (max. 30°C) ed asciugati all'aria. Stiratura a bassissima temperatura. I tessuti delle categorie B1 e C1 devono essere periodicamente puliti con un panno umido e leggero detergente neutro.

Devono essere regolarmente asciugati all'interno aprendo la cerniera e permettendo l'aerazione al fine di evitare il formarsi di muffe. Eventuali macchie devono essere pulite prontamente per evitare che si stabilizzino. Si raccomanda di seguire scrupolosamente le istruzioni di lavaggio e manutenzione indicate nel 'cartellino qualità' fornito coi mobili. Tutti i cuscini sono realizzati esclusivamente in Italia con utilizzo di imbottiture di origine italiana.

## COVERS

Per una migliore protezione dei mobili consigliamo l'uso delle nostre coperture in uno speciale tessuto impermeabile (pvc + poliestere). Le coperture proteggono dalle intemperie e dal depositarsi di polveri e impurità atmosferiche. Le coperture sono disponibili per una parte dei modelli come indicato in listino.

## FABRICS

*Roberti offers a wide choice of fabrics suitable for outdoor use and with peculiar features. All the fabric are UV resistant and have 3 price levels.*

***GROUP A1** offers a wide choice of fabrics for outdoor use, some of them acryl fabric from Sunbrella, some others polypropilene fabrics, all combined with a polyurethane padding protected by a polyester cover, water repellent. The soft back pillows and the decorative pillows contain a mix of polyester chips inside a polyester, water repellent, cover. This is the ideal proposal for cushions you can leave outside, combining the comfort of a fabric with the full protection of the padding.*

***GROUP B1** the fabrics B1 - composed of pvc, polyester and polyurethane - are water repellent. The B1 fabrics combined with padding polyurethane foams completely protected by a polyester cover offer the best waterproof solution. It can happen that some water enters through the stitches; we therefore suggest to regularly open the fabric cover zipper to permit ventilation to the inside part of the cushion. Fabrics B1 are available only for part of the collection, as specified in the pricelist.*

***GROUP C1** the fabrics C1 - composed of pvc-polyester and polyurethane - have a light polyester padding fixed by a thermowelding with horizontal stripes and are water repellent. The C1 fabrics combined with padding polyurethane foams completely protected by a polyester cover offer the best waterproof solution. It can happen that some water enters through the stitches; we therefore suggest to regularly open the fabric cover zipper to permit ventilation to the inside part of the cushion. Fabrics C1 are available only for part of the collection, as specified in the pricelist.*

*All fabrics A1 can be hand washed on cold water (max. 30°C) and air dried. Ironing only at very low temperature. Fabrics B1 and C1 must be regularly cleaned with a wet cloth and a mild detergent, but not soaked. It is also recommendable to open zippers of fabric covers regularly in order to permit ventilation inside the cushion to avoid mold stains. Stains should be immediately removed to prevent they leave an imprint. It is highly recommendable to read and carefully follow all suggestions given in the 'care and maintenance' leaflet delivered with the furniture. All cushions are entirely MADE IN ITALY using paddings of italian origin.*

## COVERS

*For an additional protection of the furniture we suggest our special covers, water repellent, made of pvc and polyester. The covers protect from weathering as well as from dust and atmospheric impurities. The covers are available for part of the models as indicated in the pricelist.*

## STOFFE

Roberti bietet eine breite Auswahl an Stoffen für den Außenbereich mit unterschiedliche Eigenschaften. Alle Stoffe haben eine starke Beständigkeit gegen UV-Strahlen. Es gibt 3 verschiedene Preiskategorien.

**GRUPPE A1** Breite Auswahl an Stoffen die für den Außenbereich geeignet sind: Acryl-Stoffe von Sunbrella und neue Polypropilene-Stoffe. Die Kissen haben Polyurethanschaum überzogen mit einem Polyestergewebe, wasserdicht. Die weichen Rückenkissen und die kleine Wurfkissen enthalten ein Mix aus Polyester-Chips und sind durch einer Polyester Hülle, wasserabstoßend, geschützt. Diese Kombination Stoff+geschützte Kissenfüllung ist die beste Lösung für den Außenbereich und bietet den richtigen Komfort sowie eine lange Haltbarkeit des Kissens.

**GRUPPE B1** Die Stoffe der Kat. B1 sind aus PVC, Polyester und Polyurethan und wirken wasserabstoßend. Der Schaumstoff ist aus Polyurethan überzogen mit einem Polyestergewebe, wasserdicht. Sollte etwas Wasser eindringen durch die Naht, empfehlen wir die Kissen abtrocknen zu lassen: einfach den Reißverschluss öffnen und das Kissen-Kern belüften und abtrocknen. Die B1 Stoffe sind nur für einige Modelle verwendbar, die auf der Preisliste angegeben sind.

**GRUPPE C1** Die Stoffe der Kat. C1 sind aus PVC, Polyester und Polyurethan und haben einen leichten Polyester-Schaum der mit einer waagerechten Heißversiegelung befestigt ist. Der Schaumstoff ist aus Polyurethan überzogen mit einem Polyestergewebe, wasserdicht. Sollte etwas Wasser eindringen durch die Naht, empfehlen wir die Kissen abtrocknen zu lassen: einfach den Reißverschluss öffnen und das Kissen-Kern belüften und abtrocknen. Die C1 Stoffe sind nur für einige Modelle verwendbar, die auf der Preisliste angegeben sind.

Die Stoffe der Kat. A1 sind Hand waschbar (kaltes Wasser max. 30°C) und haben an die Luft trocknen. Bügeln nur mit sehr niedriger Temperatur. Die Stoffe der Kat. B1 und C1 müssen regelmäßig mit einem feuchtem Lappen und neutraler Seife gereinigt werden. Um Schimmel-Bildungen zu vermeiden, empfehlen wir ein regelmäßiger Kissen-Abtrocknen. Stoff-Hülle öffnen und das Innenleben des Kissens belüften und abtrocknen. Ev. Flecken müssen sofort entfernt werden. Wir bitten die Pflegehinweise auf unseren Qualitäts-Schild (geliefert mit der Möbel) genau zu beachten. Alle Kissen sind ausschließlich in Italien hergestellt mit italienischem Schaumstoff.

## COVERS

Für einen besseren Schutz der Möbel, bieten wir wasserdichte Schutzhüllen aus Pvc und Polyester. Dadurch werden die Möbel vom Unwetter sowie auch vom atmosphärischen Unreinheiten bewahrt. Die Schutzhüllen sind nur für sämtliche Modellen - wie in der Preisliste angegeben - erhältlich.

## TISSUS

*Roberti offre une large gamme de tissus conseillés pour l'extérieur avec des caractéristiques différentes. Tous les tissus sont résistants aux rayons UV et sont représentés en 3 catégories de prix.*

***GROUPE A1** offre une large gamme de tissus pour l'extérieur avec des rembourrages des coussins en polyurethane revêtus avec un tissu en polyester imperméable. Une partie des tissus est en acryl (Sunbrella) et une partie en polypropilene. Le rembourrage des coussins souples des dos et les petits coussins décoratifs sont en chips de polyester enfermés dans une housse en polyester imperméable à l'eau. Cela est la proposition idéale pour des coussins pour l'extérieur tout en assurant le confort des tissus et la résistance à l'eau des rembourrages.*

***GROUPE B1** Les tissus B1 sont en PVC, Polyester et Polyurethane; ils sont des tissus hydrofuges. Les mousses de rembourrages sont toujours enfermées dans les revêtements en polyester ainsi le coussins est presque complètement imperméable. Il peut y avoir un passage d'eau très léger à travers les coutures. Nous conseillons donc de ouvrir les fermetures éclair et faire sécher la partie intérieure du coussin avec régularité. Ça évitera la formation de moisissure à l'intérieur. Les tissus B1 sont disponibles uniquement pour certains modèles de la collection, comme spécifié dans la liste des prix.*

***GROUPE C1** Les Tissus C1 sont en PVC, Polyester et Polyurethane; ils ont un rembourrage léger en polyester fixé par thermoscellage à bandes horizontales. Il sont des tissus imperméables à l'eau. Les mousses de rembourrages sont toujours enfermées dans les revêtements en polyester ainsi le coussins est presque complètement imperméable. Il peut y avoir un passage d'eau très léger à travers les coutures. Nous conseillons donc de ouvrir les fermetures éclair et faire sécher la partie intérieure du coussin avec régularité. Ça évitera la formation de moisissure à l'intérieur. Les tissus C1 sont disponibles uniquement pour certains modèles de la collection, comme spécifié dans la liste des prix.*

*Tous les tissus A1 peuvent être lavés à la main avec eau froide (max. 30°C) et doivent sécher à l'air. Tous les tissus B1 et C1 peuvent être nettoyés en utilisant un chiffon souple et une solution nettoyante douce, sans les laver. S'il y a des taches il faut les enlever au plus vite avant qu'elles se fixent.*

*Nous conseillons de faire sécher tous les coussins avec régularité en ouvrant la fermeture éclair des housses et permettant la ventilation. Toutes les instructions pour l'entretien et nettoyage indiquées dans la "fiche qualité" fournie avec les meubles sont à suivre avec attention. Tous les coussins sont réalisés exclusivement en Italie en utilisant des matériaux de rembourrage "made in Italy".*

## COVERS

*Pour une meilleure protection des meubles nous conseillons des housses en tissu pvc et polyester imperméables. Les housses protègent des intempéries ainsi que des poussières et impuretés atmosphériques. Elles sont disponibles pour une partie des modèles comme indiqué dans la liste des prix.*



# fabrics & covers

POLYPROPYLENE (PP)\_POLYESTHER (PL)



**Petra panna**  
100% PP  
martindale 45.000  
cat. A1  
Imo tested

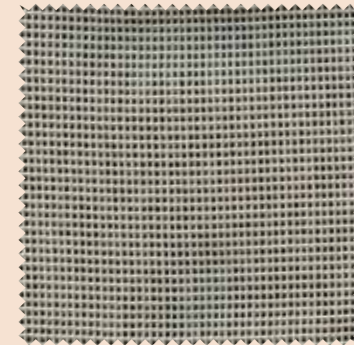

**Tricot nero**  
55% PP 45% PL  
martindale 25.000  
cat. A1  
Imo tested



**Kristal nero**  
63% PP 37% PL  
martindale 18.000  
cat. A1  
Imo tested



**Righe beige**  
52% PL 48% PP  
martindale 18.000  
cat. A1  
Imo tested

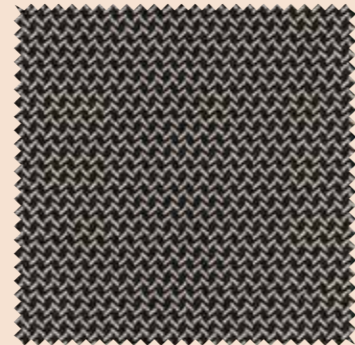

**Arabesque**  
100% PP  
martindale 40.000  
cat. A1  
Imo tested

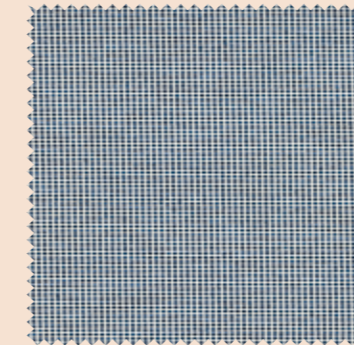

**Tricot blu**  
55% PL 45% PP  
martindale 25.000  
cat. A1  
Imo tested



**Kristal blu**  
63% PP 37% PL  
martindale 18.000  
cat. A1  
Imo tested



**Mosaic blu**  
100% PP  
martindale 50.000  
cat. A1  
Imo tested



**Oceano**  
100% PP  
martindale 40.000  
cat. A1

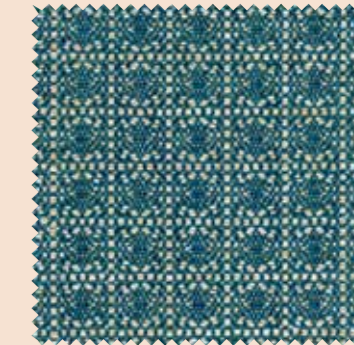

**Emerald**  
100% PP  
martindale 40.000  
cat. A1

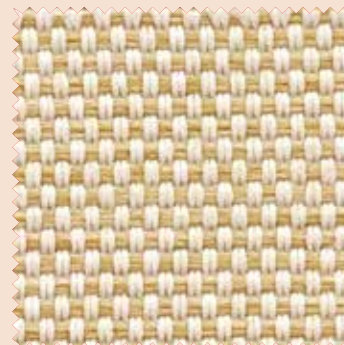

**Mosaic oromix**  
100% PP  
martindale 50.000  
cat. A1  
Imo tested



**Kristal oromix**  
63% PP 37% PL  
martindale 18.000  
cat. A1  
Imo tested



**Petra sabbia**  
100% PP  
martindale 45.000  
cat. A1  
Imo tested



**Dune beige**  
100% PP  
martindale 40.000  
cat. A1



**Iride beige**  
100% PP  
martindale 45.000  
cat. A1



**Azzurro mare**  
55% PP 45% PL  
martindale 20.000  
cat. A1  
Imo tested



**Righe azzurro**  
55% PP 45% PL  
martindale 20.000  
cat. A1  
Imo tested

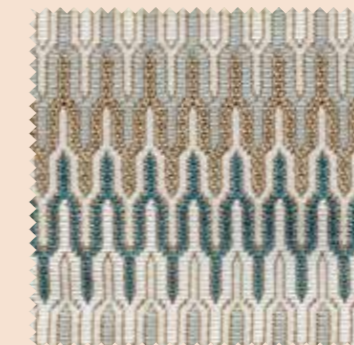

**Orient azzurro**  
60% PP 40% PL  
martindale 20.000  
cat. A1

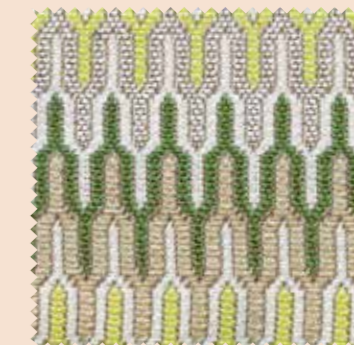

**Orient verde**  
60% PP 40% PL  
martindale 20.000  
cat. A1



**Trama bianca**  
100% PP  
martindale 35.000  
cat. A1

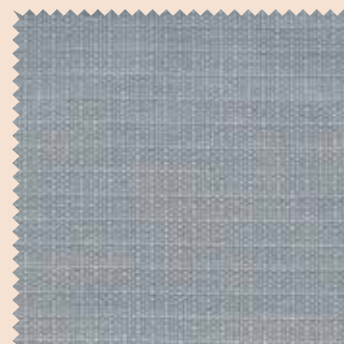

**Azzurro polvere**  
100% PP  
martindale 45.000  
cat. A1  
Imo tested

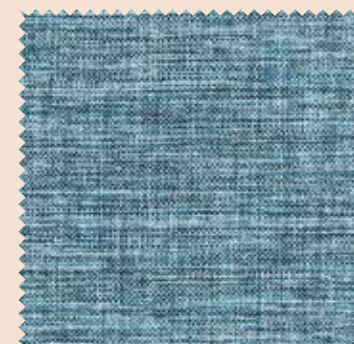

**Iride turchese**  
100% PP  
martindale 40.000  
cat. A1



**Dune turchesi**  
100% PP  
martindale 40.000  
cat. A1

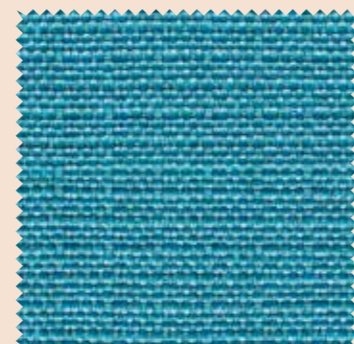

**Petra azzurro**  
100% PP  
martindale 45.000  
cat. A1  
Imo tested



**Onde azzurro**  
60% PP 40% PL  
martindale 20.000  
cat. A1  
Imo tested



**Tricot ocra**  
55% PP 45% PL  
martindale 25.000  
cat. A1  
Imo tested



**Kristal ocra**  
63% PP 37% PL  
martindale 18.000  
cat. A1  
Imo tested



**Mosaic ocra**  
100% PP  
martindale 50.000  
cat. A1  
Imo tested

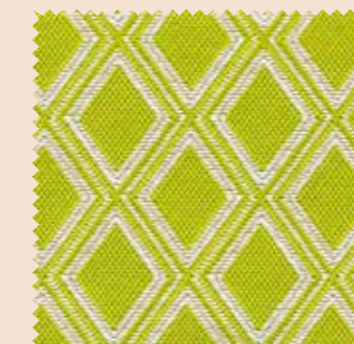

**Rombi verdi**  
100% PP  
martindale 25.000  
cat. A1



**Pistacchio**  
100% PP  
martindale 35.000  
cat. A1

POLYPROPYLENE (PP) - PVC



**Flowers**  
100% PP  
martindale 25.000  
cat. A1



**Nautic white**  
87% PVC 12% PL 1% PU  
martindale 300.000  
cat. B1

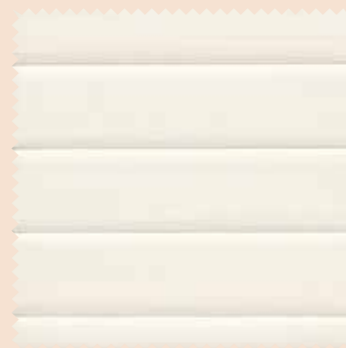

**Nautic stripe white**  
87% PVC 12% PL 1% PU  
martindale 300.000  
cat. C1



**Nautic taupe**  
87% PVC 12% PL 1% PU  
martindale 300.000  
cat. B1

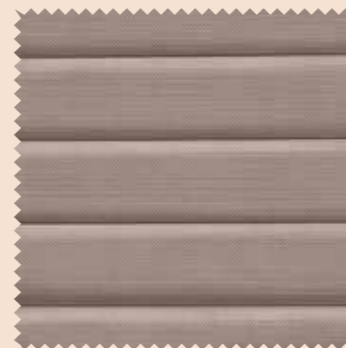

**Nautic stripe taupe**  
87% PVC 12% PL 1% PU  
martindale 300.000  
cat. C1

ACRILIC (PC)



**Natte bianco**  
100% PC  
martindale 16.000  
cat. A1



**Natte erica**  
100% PC  
martindale 16.000  
cat. A1

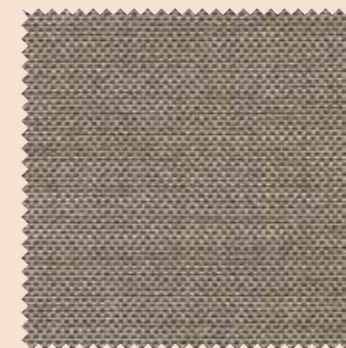

**Natte fumo**  
100% PC  
martindale 19.000  
cat. A1



**Natte grigio**  
100% PC  
martindale 19.000  
cat. A1

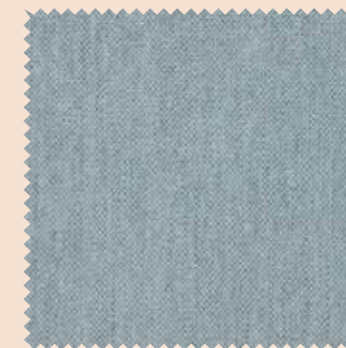

**Natte azzurro**  
100% PC  
martindale 17.000  
cat. A1

ACRILIC (PC)



**Bianco**  
100% PC  
martindale 20.000  
cat. A1



**Avana**  
100% PC  
martindale 17.000  
cat. A1



**Noce**  
100% PC  
martindale 20.000  
cat. A1

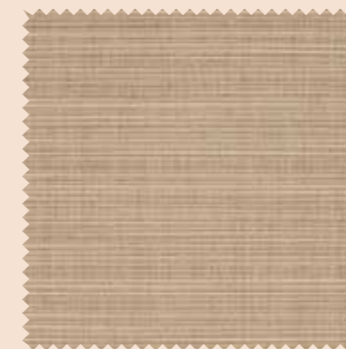

**Sand**  
100% PC  
martindale 10.000  
cat. A1

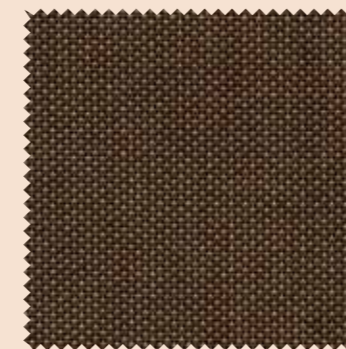

**Brownies**  
100% PC  
martindale 15.000  
cat. A1



**Tortora**  
100% PC  
martindale 15.000  
cat. A1

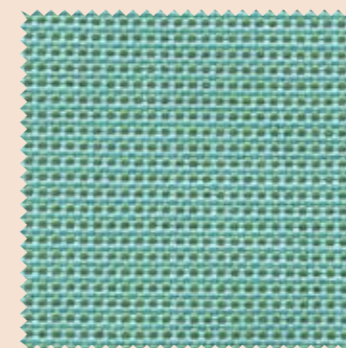

**Giada \***  
100% PC  
martindale 20.000  
cat. A1

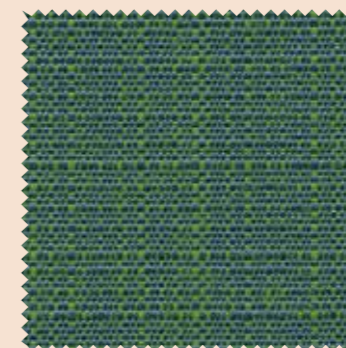

**Smeraldo \***  
100% PC  
martindale 20.000  
cat. A1

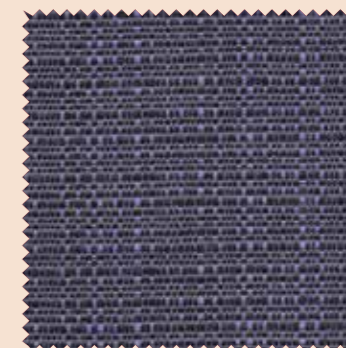

**Melanzana \***  
100% PC  
martindale 20.000  
cat. A1

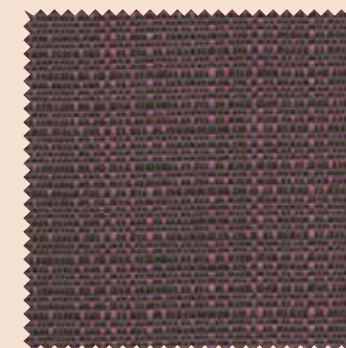

**Rubino \***  
100% PC  
martindale 20.000  
cat. A1



**Cover**  
pl-pvc



I tessuti contrassegnati con questo simbolo, sono di fine serie e s'intendono disponibili solo fino ad esaurimento scorte.  
The fabrics with this symbol are out of production and only available until stocks last.  
Die gekennzeichneten Stoffe sind auslaufend und können nur solange der Lagervorrat reicht, geliefert werden.  
Les tissus avec ce symbole sont hors production et encore disponibles jusqu'à épuisement des stocks.

# Drawings

## Capri / Santiago Sevillano



Nato a Valencia nel 1975.  
Santiago Sevillano ha studiato design industriale all'ESDI CEU, poi si è specializzato al Politecnico di Valencia e alla Scuola di Architettura.  
Nel 2003 ha fondato il suo studio a Valencia.

*Born in Valencia in 1975.  
Santiago Sevillano is a young designer who studied industrial design at the ESDI CEU, later specializing at the Polytechnic University in Valencia and at the School of Architecture. In 2003 he founded his studio in Valencia.*



**art. 4301**  
cm 58x61x79h  
(Hs. cm 45+2)



**art. 4325**  
cm ø 130x74h  
only hpl light slate

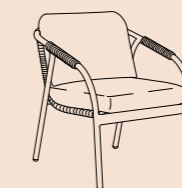

**art. 4311**  
cm 69x78x75h  
(Hs. cm 37+10)



**art. 4318H**  
cm ø 58x36h  
only slate stone

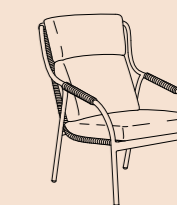

**art. 4315**  
cm 71x92x106h  
(Hs. cm 37+10)

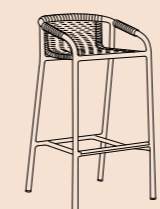

**art. 4305**  
cm 49x48x90h  
(Hs. cm 74)



**art. 4326**  
cm ø 150x74h  
only hpl light slate

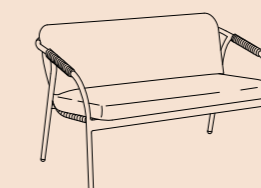

**art. 4312**  
cm 138x78x75h  
(Hs. cm 37+10)



**art. 4319H**  
cm ø 78x45h  
only slate stone



**art. 4316**  
cm 62x58x37h  
(Hs. cm 37+8)

white

round searope  
pearl

hpl marble white

graphite

round searope  
dark grey

hpl slate stone

hpl light slate

# Lipari

Simone Fanciullacci\_Antonio De Marco



Nato a Varazze in Liguria, nel 2007 consegue la Laurea in Design del Prodotto presso il Politecnico di Milano e l'anno seguente perfeziona la sua formazione seguendo, presso la stessa istituzione, il corso di alta formazione in Design del Prodotto in Plastica. Parallelemente all'attività di progettazione, dal 2011 e' Cultore della Materia presso la Facolta' del Design del Politecnico di Milano.

*Born in Varazze - Liguria, in 2007 he graduated in Product Design at the Milan Polytechnic, and the following year he perfected his educational background pursuing a course - in the same institution - of advanced training in Design of the plastic product. Alongside the design activities, since 2011 he is Cultore della Materia at the Design Faculty of the Milan Polytechnic.*

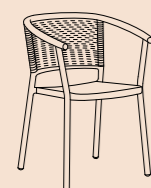

**art. 4331**  
cm 60x54x81h  
(Hs. cm 46+2)

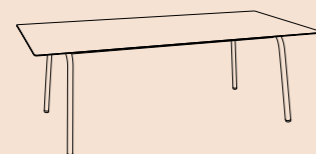

**art. 9777**  
cm 110x260x74h  
R&D Roberti

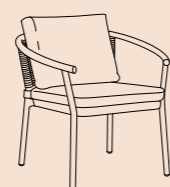

**art. 4341**  
cm 74x70x71h  
(Hs. cm 40+6)

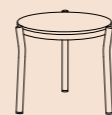

**art. 4348H**  
cm ø 51x41h

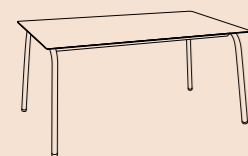

**art. 9775**  
cm 100x180x74h  
R&D Roberti

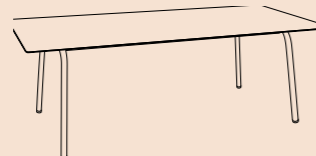

**art. 9778**  
cm 110x300x74h  
R&D Roberti

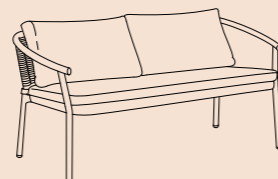

**art. 4342**  
cm 150x75x71h  
(Hs. cm 40+6)

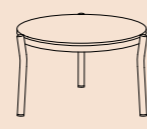

**art. 4349H**  
cm ø 66x36h

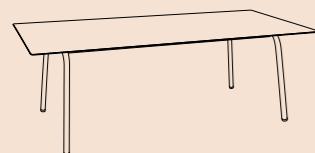

**art. 9776**  
cm 110x220x74h  
R&D Roberti

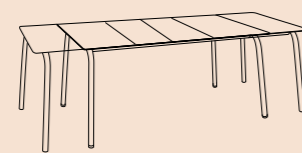

**art. 9779**  
cm 100x180/230x74h  
R&D Roberti



white

oval searope pearl

hpl marble white

graphite

oval searope silver

hpl slate stone

# Atollo

Antonio De Marco\_Simone Fanciullacci

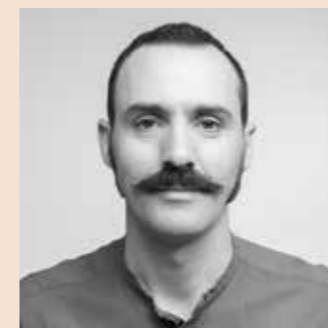

Studia al Politecnico di Milano, alla Royal Danish Academy di Copenaghen e consegue un master all'Istituto Marangoni di Milano. Oltre all'attività di progettazione insegna nel master di Design Methodology della NABA di Milano e Scuola Politecnica di Design. He studied at the Politecnico di Milano, at the Royal Danish Academy in Copenhagen and holds a master at the Marangoni Institute in Milan. Alongside the design activity he teaches in the Design Methodology Master of Milan's NABA and Design Polytechnic School.

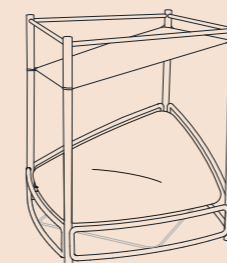

**art. 4360**  
cm 200x200x240h

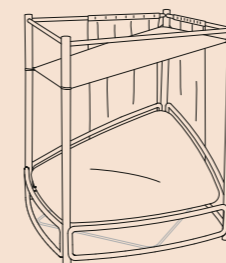

**art. 4361**  
cm 200x200x240h

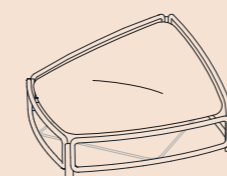

**art. 4365**  
cm 200x200x103h/39h



white

cipria

# Gravity

Technical Emotions



Technical Emotions è stata fondata nel 2010 dalle sorelle Alos Palop: Maria de les Neus, laureata in architettura presso l'Università Politecnica di Valencia, e Laia laureata in design industriale presso l'ESDI CEU.

*Technical Emotions was founded in 2010 by Alos Palop sisters: Maria de les Neus, graduated in Architecture at the Valencia University and Laia graduated in industrial design at ESDI CEU.*

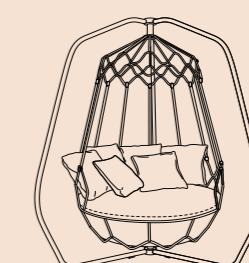

**art. 9880**  
cm 174x167x238h  
(Hs. cm 60)

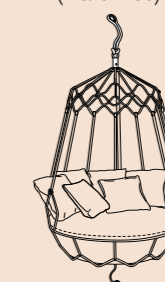

**art. 9881**  
cm ø 133x238h  
(Hs. cm 60)

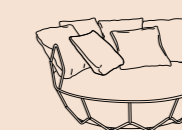

**art. 9882**  
cm ø 133x87h  
(Hs. cm 40)



**art. 9885**  
cm ø 80x42h



**art. 9886**  
cm ø 80x42h



champagne

nautic rope sand

graphite

nautic rope black



Un atelier in continuo fermento, a metà strada tra un laboratorio creativo ed un'officina di produzione. Fondato da Adriano Balutto si è arricchito della presenza della figlia, l'arch. Veronica Balutto, laureata all'Istituto Universitario di Architettura di Venezia ( IUAV ). Dal 2006 e' anche giornalista pubblicitista.

*Naturally born for creativity and planning Studio Balutto has always been in movement to research new innovative ideas to be up to the expectations of the market trends and requests. Founded by Adriano Balutto, in the last years the atelier has had the creativity support of his daughter arch. Veronica Balutto, graduated at the University Institute of Architecture in Venice. Since 2006 she is also a journalist.*



Nato a Valencia nel 1975. Santiago Sevillano ha studiato design industriale all'ESDI CEU, poi si è specializzato al Politecnico di Valencia e alla Scuola di Architettura. Nel 2003 ha fondato il suo studio a Valencia.

*Born in Valencia in 1975. Santiago Sevillano is a young designer who studied industrial design at the ESDI CEU, later specializing at the Polytechnic University in Valencia and at the School of Architecture. In 2003 he founded his studio in Valencia.*

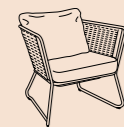

**art. 9741**  
cm 75x75x83h  
(Hs. cm 35+10)



**art. 9745**  
cm 71x71x36h



**art. 9770**  
cm 68x60x45h



**art. 9767**  
cm 230x153x200h  
(in. 186x153)  
(Hs. cm 26+15)



**art. 9740**  
cm 55x57x85h  
(Hs. cm 45+2)

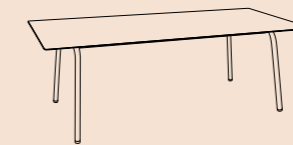

**art. 9776**  
cm 110x220x74h  
R&D Roberti

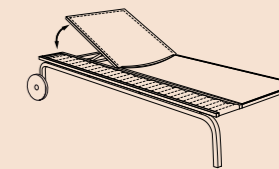

**art. 9749R**  
cm 97x213x35h  
(Hs. cm 35+5)  
R&D Roberti

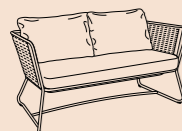

**art. 9742**  
cm 152x75x83h  
(Hs. cm 35+10)



**art. 9746**  
cm 120x71x36h

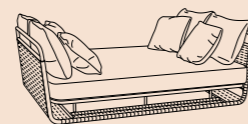

**art. 9765**  
cm 207x153x85h  
(in. 186x153)  
(Hs. cm 26+15)



**art. 9768**



**art. 9740 / B**  
cm 61x57x85h  
(Hs. cm 45+2)

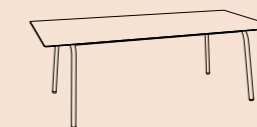

**art. 9777**  
cm 110x260x74h  
R&D Roberti

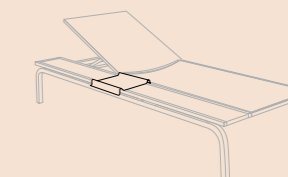

**art. 9748**  
cm 32x25x4h  
R&D Roberti

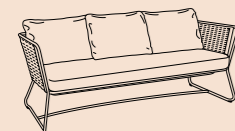

**art. 9743**  
cm 207x75x83h  
(Hs. cm 35+10)



**art. 9766**

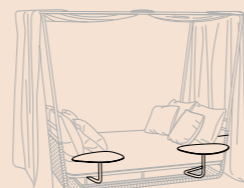

**art. 9769 / D**  
**art. 9769 / S**  
cm 48,5x32x26h



**art. 9771**  
cm 50x53x94,5h  
(Hs. cm 75)

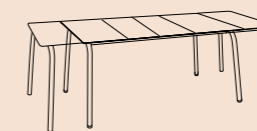

**art. 9779**  
cm 100x180/230x74h  
R&D Roberti

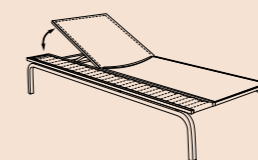

**art. 9749**  
cm 90x205x35h  
(Hs. cm 35+5)  
R&D Roberti

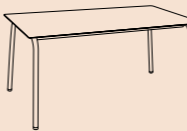

**art. 9775**  
cm 100x180x74h  
R&D Roberti





Nato a Valencia nel 1975. Santiago Sevillano ha studiato design industriale all'ESDI CEU, poi si è specializzato al Politecnico di Valencia e alla Scuola di Architettura. Nel 2003 ha fondato il suo studio a Valencia.

*Born in Valencia in 1975. Santiago Sevillano is a young designer who studied industrial design at the ESDI CEU, later specializing at the Polytechnic University in Valencia and at the School of Architecture. In 2003 he founded his studio in Valencia.*



**art. 9860**  
oval sunloom  
cm 55x54x80h  
(Hs. cm 46)

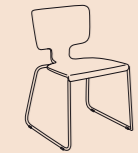

**art. 9860FA**  
cm 55x54x80h  
(Hs. cm 46)

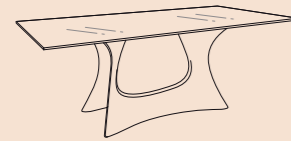

**art. 9865F**  
laquered glass top  
cm 110x220x74h

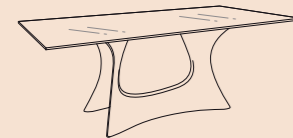

**art. 9866F**  
laquered glass top  
cm 110x260x74h

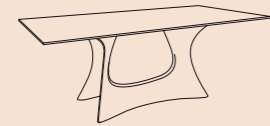

**art. 9867F**  
HPL top  
cm 110x220x74h

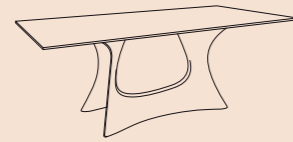

**art. 9868F**  
HPL top  
cm 110x260x74h

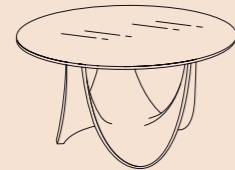

**art. 9870F**  
transparent glass top  
cm diam. 150x74h

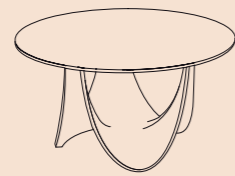

**art. 9871F**  
HPL top  
cm diam. 150x74h

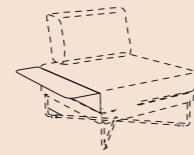

**art. 9800**  
cm 24x77x21h

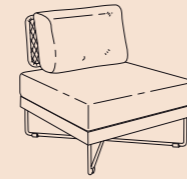

**art. 9801**  
oval sunloom  
cm 75x83x83h  
(Hs. cm 26+15)

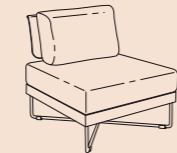

**art. 9801FA**  
cm 75x79x83h  
(Hs. cm 26+15)

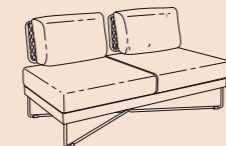

**art. 9802**  
oval sunloom  
cm 150x83x83h  
(Hs. cm 26+15)

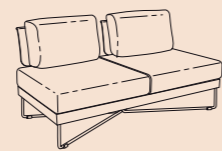

**art. 9802FA**  
cm 150x79x83h  
(Hs. cm 26+15)

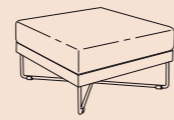

**art. 9803**  
cm 77x77x41h  
(Hs. cm 26+15)

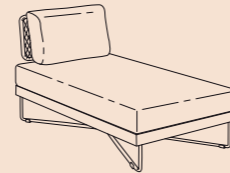

**art. 9804**  
oval sunloom  
cm 75x156x83h  
(Hs. cm 26+15)

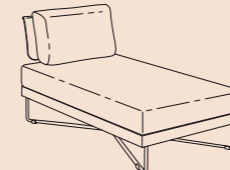

**art. 9804FA**  
cm 75x152x83h  
(Hs. cm 26+15)



**art. 9805**  
oval sunloom  
cm 150x206x83h  
(Hs. cm 26+15)



**art. 9805FA**  
cm 150x202x83h  
(Hs. cm 26+15)



**art. 9806**  
cm 150x200x41h  
(Hs. cm 26+15)

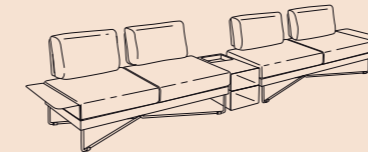

**art. 9832**  
oval sunloom  
cm 380x83x83h  
(Hs. cm 26+15)

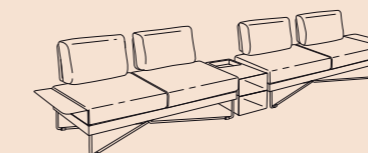

**art. 9832FA**  
cm 380x79x83h  
(Hs. cm 26+15)

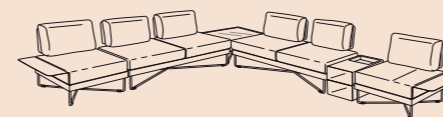

**art. 9840**  
oval sunloom  
cm 326x358x83x83h  
(Hs. cm 26+15)

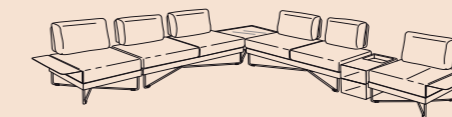

**art. 9840FA**  
cm 326x358x79x83h  
(Hs. cm 26+15)

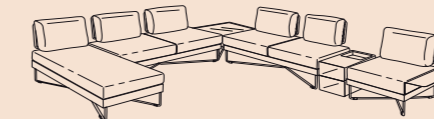

**art. 9841**  
oval sunloom  
cm 302x358x83/155x83h  
(Hs. cm 26+15)

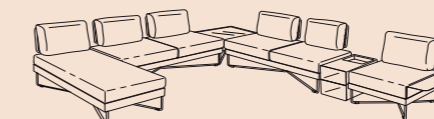

**art. 9841FA**  
cm 302x358x79/152x83h  
(Hs. cm 26+15)

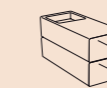

**art. 9818**  
cm 32x77x41h



**art. 9817**  
cm 77x77x26h



**art. 9859**  
fibreglass  
cm 50x36x51h



**art. 9850**  
cm 110x65x41h

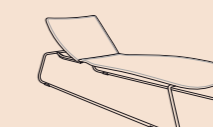

**art. 9857**  
oval sunloom  
cm 80x200x43h

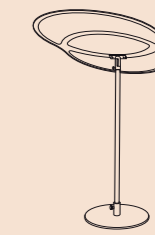

**art. 9852**  
cm 130x170x200h  
only white - corda

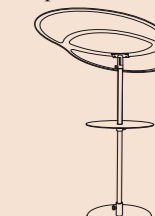

**art. 9854**  
cm 130x170x200h  
ø 70x0,5h  
only white - corda  
(glazed steel stand)

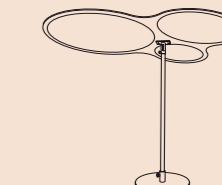

**art. 9853**  
cm 199x141x200h  
only white - corda  
(glazed steel stand)

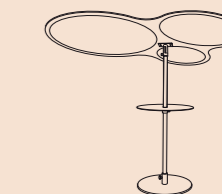

**art. 9855**  
cm 199x141x200h  
ø 70x0,5h  
only white - corda  
(glazed steel stand)



# Hamptons Graphics / G.V. Plazzogna R. Papparotto



Gianvittorio Plazzogna nato a Treviso, si laurea in architettura a Venezia. Inizialmente art director presso lo studio Quadragono, apre a Treviso il proprio studio professionale occupandosi di grafica pubblicitaria e di product design. Lo studio si occupa del design e dell'immagine coordinata di diverse aziende operanti nel settore del mobile.

*Gianvittorio Plazzogna was born in Treviso and got a degree in Architecture in Venice. He is processing product design collaborating with many companies in the furniture field and also developing complete shops equipment and interior decoration.*



Roberto Papparotto nasce a Treviso nel 1976, frequenta lo IUAV, Istituto Universitario di Architettura di Venezia dove si laurea a pieni voti in Disegno Industriale. Dal 2003 collabora con l'architetto Gianvittorio Plazzogna a progetti di design e art-direction per numerose aziende.

*Roberto Papparotto was born in Treviso in 1976, attended IUAV (Architecture University Institute) in Venice getting a degree with full marks in Industrial Design. Since 2003 he has been collaborating with Arch. Gianvittorio Plazzogna regarding design projects and art-direction of Companies*



**art. 9750**  
cm 56x60x80h  
(Hs. cm 44+3)



**art. 9724**  
*straps only coffee*  
cm 55x56x80h  
(Hs. cm 45)

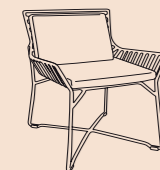

**art. 9751**  
cm 56x60x80h  
(Hs. cm 44+3)



**art. 9720**  
*sunweave bianco perla*  
cm 46x56x80h  
(Hs. cm 45)

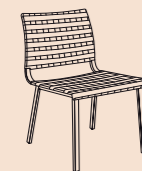

**art. 9723**  
*straps only coffee*  
cm 46x56x80h  
(Hs. cm 45)

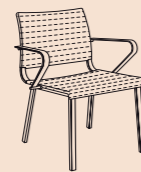

**art. 9721**  
*sunweave bianco perla*  
cm 55x56x80h  
(Hs. cm 45)



**art. 9725**  
*glazed glass top*  
cm 110x220x73h



**art. 9727**  
*HPL top*  
cm 110x220x74h



**art. 9726**  
*glazed glass top*  
cm 110x260x73h



**art. 9728**  
*HPL top*  
cm 110x260x74h



**art. 9730**  
*HPL top*  
cm 160x160x74h

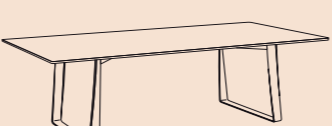

**art. 9729**  
*HPL top*  
cm 110x300x74h

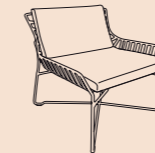

**art. 9733**  
cm 75x77x73h  
(Hs. cm 36+6)

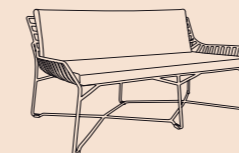

**art. 9734**  
cm 135x77x73h  
(Hs. cm 36+6)

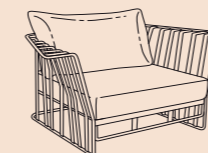

**art. 9731**  
cm 122x93x78h  
(Hs. cm 25+15)

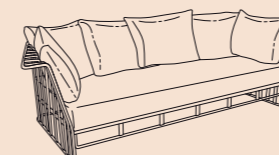

**art. 9732**  
cm 240x100x78h  
(Hs. cm 25+15)

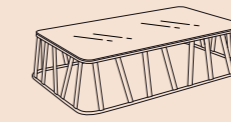

**art. 9736**  
*glass top*  
cm 130x81x30h

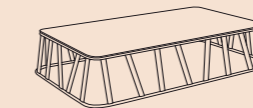

**art. 9736H**  
*HPL top*  
cm 130x81x30h



**art. 9735**  
*glass top*  
cm 81x81x30h

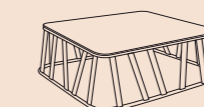

**art. 9735H**  
*HPL top*  
cm 81x81x30h

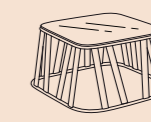

**art. 9739**  
*glass top*  
cm 50x50x30h

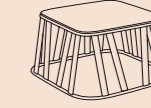

**art. 9739H**  
*HPL top*  
cm 50x50x30h



**art. 9755**  
cm 99x72x78h  
(Hs. cm 43+3)



white

sunweave bianco perla

hpl white

coffee

straps coffee

hpl corten

\* Gli articoli contrassegnati con questo simbolo, sono di fine serie e s'intendono disponibili solo fino ad esaurimento scorte.  
*The articles marked with this symbol are out of production and only available until stocks last.*  
Die Modelle auslaufend sind nicht mehr in Produktion und können nur solange der Lagerbestand reicht, geliefert werden.  
*Les articles avec ce symbole sont hors production et encore disponibles jusqu'à épuisement des stocks.*



Gianvittorio Plazzogna nato a Treviso, si laurea in architettura a Venezia. Inizialmente art director presso lo studio Quadrangolo, apre a Treviso il proprio studio professionale occupandosi di grafica pubblicitaria e di product design. Lo studio si occupa del design e dell'immagine coordinata di diverse aziende operanti nel settore del mobile.

*Gianvittorio Plazzogna was born in Treviso and got a degree in Architecture in Venice. He is processing product design collaborating with many companies in the furniture field and also developing complete shops equipment and interior decoration.*



Roberto Papparotto nasce a Treviso nel 1976, frequenta lo IUAV, Istituto Universitario di Architettura di Venezia dove si laurea a pieni voti in Disegno Industriale. Dal 2003 collabora con l'architetto Gianvittorio Plazzogna a progetti di design e art-direction per numerose aziende.

*Roberto Papparotto was born in Treviso in 1976, attended IUAV (Architecture University Institute) in Venice getting a degree with full marks in Industrial Design. Since 2003 he has been collaborating with Arch. Gianvittorio Plazzogna regarding design projects and art-direction of Companies*

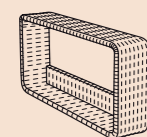

**art. 9600**  
cm 18x100x50h

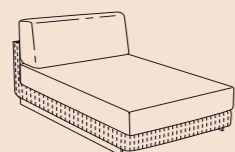

**art. 9603**  
cm 86x175x78h  
(Hs. cm 19+19)

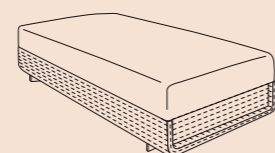

**art. 9609**  
cm 86x200x38h  
(Hs. cm 19+19) \*

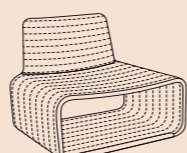

**art. 9625**  
cm 80x76x78h  
(Hs. cm 41+2,5)

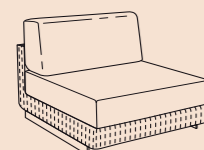

**art. 9601**  
cm 75x102x78h  
(Hs. cm 19+19)

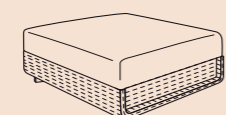

**art. 9608**  
cm 86x86x38h  
(Hs. cm 19+19)

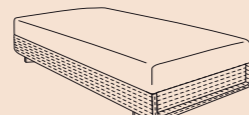

**art. 9605**  
cm 70x180x38h  
(Hs. cm 19+19)  
*only white* \*

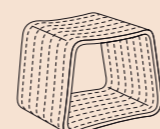

**art. 9626**  
cm 46x37x42h

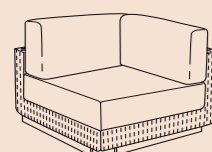

**art. 9602**  
cm 104x104x78h  
(Hs. cm 19+19)

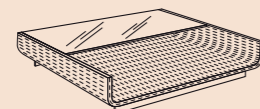

**art. 9607**  
cm 86x86x19h

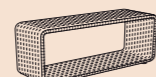

**art. 9606**  
cm 120x40x50h  
*only musk* \*

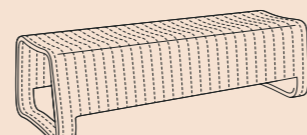

**art. 9627**  
cm 130x46x42h \*

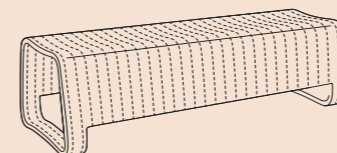

**art. 9628**  
cm 160x46x42h \*

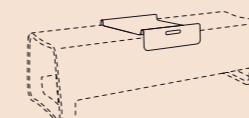

**art. 9629**  
cm 39x37x10h

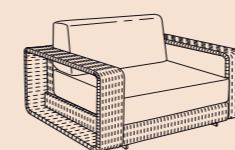

**art. 9611**  
cm 111x102x78h  
(Hs. cm 19+19)

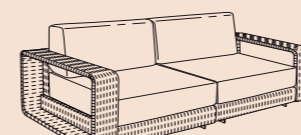

**art. 9612**  
cm 186x102x78h  
(Hs. cm 19+19)

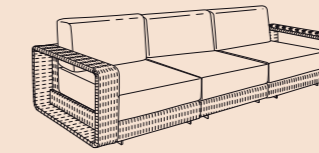

**art. 9613**  
cm 261x102x78h  
(Hs. cm 19+19)

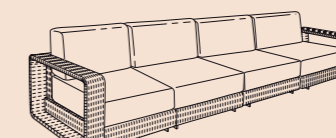

**art. 9614**  
cm 336x102x78h  
(Hs. cm 19+19)

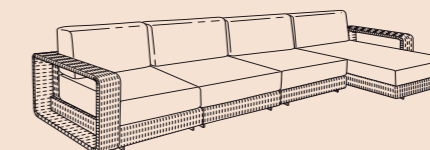

**art. 9618**  
cm 347x102/177x78h  
(Hs. cm 19+19)

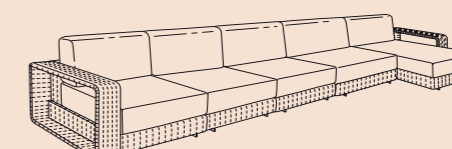

**art. 9619**  
cm 422x102/177x78h  
(Hs. cm 19+19)

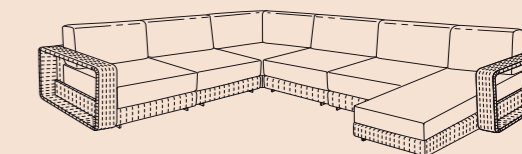

**art. 9620**  
cm 358x272x102/177x78h  
(Hs. cm 19+19)

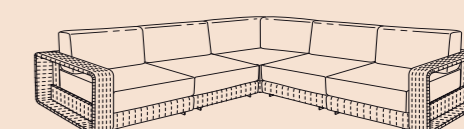

**art. 9615**  
cm 272x272x102x78h  
(Hs. cm 19+19)

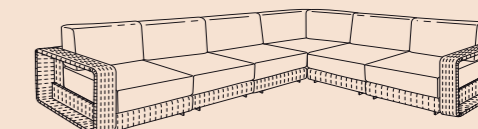

**art. 9616**  
cm 347x272x102x78h  
(Hs. cm 19+19)

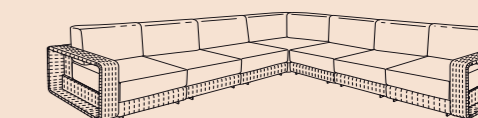

**art. 9617**  
cm 347x347x102x78h  
(Hs. cm 19+19)



sunweave bianco perla



sunweave musk





Un atelier in continuo fermento, a metà strada tra un laboratorio creativo ed un'officina di produzione. Fondato da Adriano Balutto si è arricchito della presenza della figlia, l'arch. Veronica Balutto, laureata all'Istituto Universitario di Architettura di Venezia ( IUAV ). Dal 2006 e' anche giornalista pubblicista.

*Naturally born for creativity and planning, Studio Balutto has always been in movement to research new innovative ideas to be up to the expectations of the market trends and requests. Founded by Adriano Balutto, in the last years the atelier has had the creativity support of his daughter arch. Veronica Balutto, graduated at the University Institute of Architecture in Venice. Since 2006 she is also a journalist.*

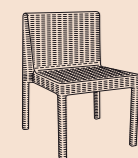

**art. 9540**  
cm 55x58x78h  
(Hs. cm 45)

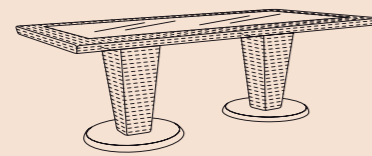

**art. 9544**  
cm 100x220x75h



**art. 9541**  
cm 63x58x78h  
(Hs. cm 45)

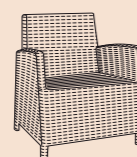

**art. 9543**  
cm 60x62x80h  
(Hs. cm 43+5)

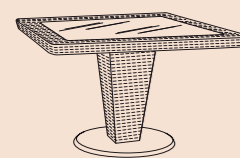

**art. 9542**  
cm 100x100x75h

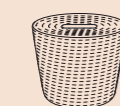

**art. 9572**  
cm ø 45x45h

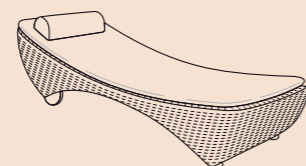

**art. 9567**  
cm 72x200x51h  
(Hs. cm 28+2,5)

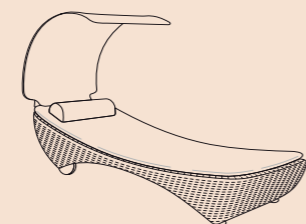

**art. 9568**  
cm 72x200x122h  
(Hs. cm 28+2,5)

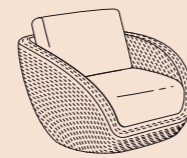

**art. 9575**  
cm 86x95x82  
(Hs. cm 20+20)

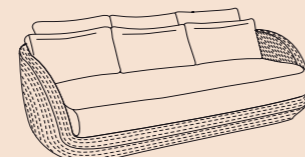

**art. 9576**  
cm 186x116x82h  
(Hs. cm 20+20)

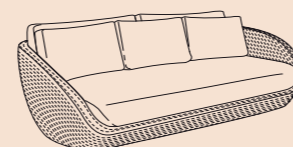

**art. 9579**  
cm 222x116x82h  
(Hs. cm 20+20)

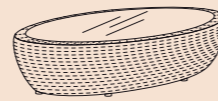

**art. 9557**  
cm 110x60x32h

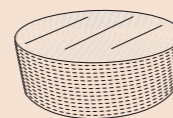

**art. 9573**  
cm ø 70x30h



Un atelier in continuo fermento, a metà strada tra un laboratorio creativo ed un'officina di produzione. Fondato da Adriano Balutto si è arricchito della presenza della figlia, l'arch. Veronica Balutto, laureata all'Istituto Universitario di Architettura di Venezia ( IUAV ). Dal 2006 e' anche giornalista pubblicista.

*Naturally born for creativity and planning, Studio Balutto has always been in movement to research new innovative ideas to be up to the expectations of the market trends and requests. Founded by Adriano Balutto, in the last years the atelier has had the creativity support of his daughter arch. Veronica Balutto, graduated at the University Institute of Architecture in Venice. Since 2006 she is also a journalist.*

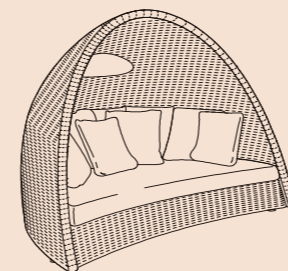

**art. 9631**  
cm 175x145x150h  
(Hs. cm 23+11)

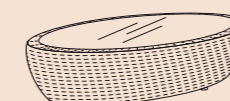

**art. 9634**  
cm 110x60x32h

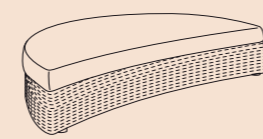

**art. 9632**  
cm 163x135x34h  
(Hs. cm 23+11)

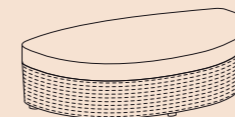

**art. 9635**  
cm 165x80x34h  
(Hs. cm 23+11)



# Samba Rio

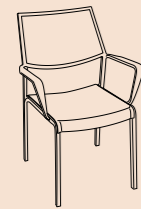

**art. 9760**  
cm 58x60x86h  
(Hs. cm 46)

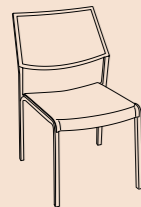

**art. 9761**  
cm 48x58x82h  
(Hs. cm 46)



**art. 9772**  
cm 50x50x96,5  
(Hs. cm 74)

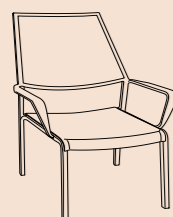

**art. 9762**  
cm 74x65x90h  
(Hs. cm 41)

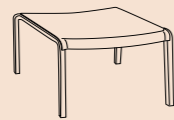

**art. 9763**  
cm 55x50x41h



**art. 9764**  
cm 50,5x34x6h

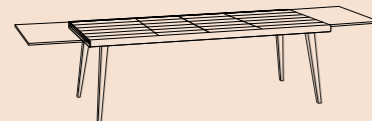

**art. 9744**  
cm 100x240/350x75h  
aluminum top

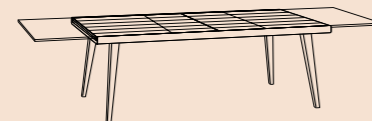

**art. 9744/B**  
cm 100x180/260x75h  
aluminum top



**art. 9773**  
cm 52x52x71h

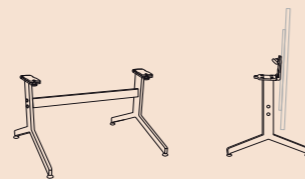

**art. 9774**  
cm 78x72x73h

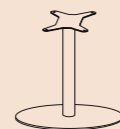

**art. 9590**  
cm ø 72x72h  
only aluminum top

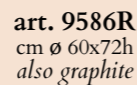

**art. 9586R**  
cm ø 60x72h  
also graphite

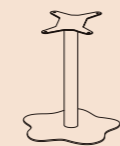

**art. 9586**  
cm ø 60x72h  
only aluminum

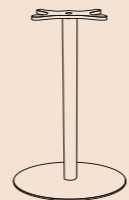

**art. 9783**  
cm ø 60x107h  
also graphite

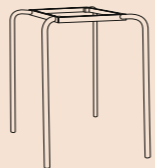

**art. 9780**  
cm 70x70x107h

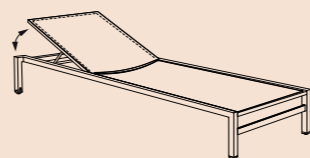

**art. 9900A**  
cm 78,5x195x32h  
(Hs. cm 32+3)  
only batyline bianco/terra

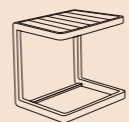

**art. 9901**  
cm 40x40x45h  
aluminum top

**RCD** Registered Community Design  
Modello Comunitario Registrato  
Gravity Collection



Gli articoli contrassegnati con questo simbolo, sono di fine serie e s'intendono disponibili solo fino ad esaurimento scorte.

*The articles marked with this symbol are out of production and only available until stocks last.*  
*Die auslaufende Modelle sind nicht mehr in Produktion und können nur solange der Lagervorrat reicht, geliefert werden.*

*Les articles avec ce symbole sont hors production et encore disponibles jusqu'à épuisement des stocks.*



I tessuti contrassegnati con questo simbolo, sono di fine serie e s'intendono disponibili solo fino ad esaurimento scorte.

*The fabrics with this symbol are out of production and only available until stocks last.*  
*Die gekennzeichneten Stoffe auslaufend sind nicht mehr in Produktion und können nur solange der Lagervorrat reicht, geliefert werden.*

*Les tissus avec ce symbole sont hors production et encore disponibles jusqu'à épuisement des stocks.*

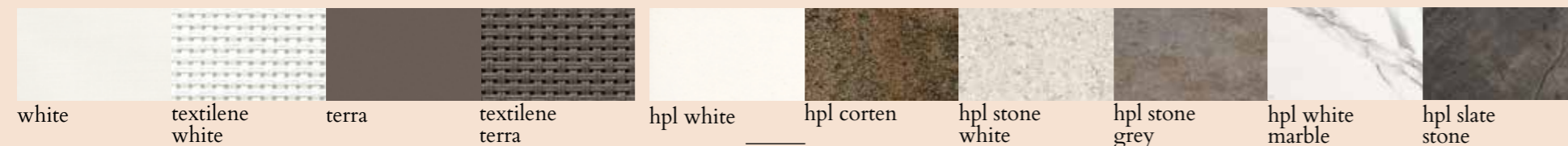

white

textilene white

terra

textilene terra

hpl white

hpl corten

hpl stone white

hpl stone grey

hpl white marble

hpl slate stone

# Contract

---

## ITALIA

Agriturismo Tenuta di Montemassi - Montemassi (GR)  
Alpenrose - Laives (BZ)  
Antiche Terme - Grado (GO)  
Avalon Wellness center - Sgonico (TS)  
Azienda Agricola Celesia Lorenza - Capalbio (GR)  
Bar Caffè' Adler - Bolzano  
Bar La Fenice - Grado - Gorizia  
Bar Pasticceria Sajeva - Agrigento  
Barcadero - Salo' (BS)  
Café 113 - Casteldacia (PA)  
Caffè Villa Frainela - Selva di Val Gardena (BZ)  
CO.BA' beach restaurant - Porto San Giorgio (FM)  
Gran Bar Park Palace - Lignano Pineta - Udine  
Grand Hotel Imperiale - Moltrasio - Como  
Gaudi Wine & Restaurant - Jesolo Lido - Venezia  
Gabbiano Azzurro Hotel & Suites - Golfo Aranci  
Stone art Café - Ghilarza - Oristano  
Hotel Arnika - Passo San Pellegrino (TN)  
Hotel Brunner Hof - Chiusa (BZ)  
Hotel Byron Bellavista - Jesolo Lido (VE)  
Hotel Cala Luna - Cala Gonone - Nuoro  
Hotel Carlton - Jesolo Lido (VE)  
Hotel Carlos V - Alghero - Sassari  
Hotel Desiree - Sirmione - Brescia  
Hotel Lisetta - Tirolo - Bolzano  
Hotel Punta Tragara - Capri - Napoli  
Hotel Pullman Timi Ama - Villasimius - Cagliari  
Hotel Sonnwies - Luson - Bolzano  
Hotel Erika - San Vigilio (TN)  
Hotel Gran Palace - Merano (BZ)  
Hotel Gritti Palace - Venezia  
Hotel Vinschgerhof - Vezzabo - Bolzano  
Kallikoros Hotel Spa Resort - Noto (SR)  
Jesolopalace Hotel & Aparthotel - Lido di Jesolo ( VE )  
L&H Lifestyle - Brenzone - Lago di Garda (VR)  
La Torrefazione - Feltre (BL)  
Locanda del Sant'Uffizio - Cioccaro di Penango (AT)  
Maso Botes - Varignano di Arco (TN)  
Park Hotel Pineta Residence - Eraclea (VE)  
Podere San Sanino - Torrita di Siena (SI)  
Quid Best Western Hotel - Trento Nord  
Residence Capo Nord - Aprilia Marittima (UD)  
Residence Corte del Mare - Aprilia Marittima (UD)

Ristorante Cial de Brent - Polcenigo (PN)  
Ristorante Il Tamburello - Castelfranco (VE)  
Ristorante Pizzeria Zi Gaetana - Roma  
Rosapetra Spa Resort - Cortina (BL)  
Savoy Beach Hotel - Bibione (VE)  
Sesto Senso - San Fior (TV)  
Terme di Chianciano spa - Chianciano (SI)  
Tre Merli Beach Hotel - Trieste  
Villa Frainela - Selva Di Val Gardena - Bolzano  
Zerouno Steak House - Arcene (BG)

## CORSICA

Domaine de Terra Porra - Porto Vecchio

## AFRICA

Sheraton Hotel - Addis Ababa - Ethiopia  
Hotel Villa Madiba - Pointe Noire - Congo

## AUSTRIA

Aqua Dome Tirol Therme - Längenfeld  
Reiters Reserve und Golf Hotel - Bad Tatzmannsdorf  
Heiltherme Bad Waltersdorf - Bad Waltersdorf  
Hotel Alpenrose - Elbingenalp  
Hotel Austria Alpine Resort - Fieberbrunn  
Hotel Laurus - Lech  
Hotel Hoflehner  
Hotel Gassner - Neukirchen a.Grossvenedige  
Hotel Laurus - Lech  
Hotel Thermenhof Paierl - Bad Waltersdorf  
Hotel und Spa Larimar - Stegersbach  
Hotel Winzer - St. Georgen im Attergau (Salzkammergut)  
Laguna Thermen - Geinberg  
Landzeit Autobahn-Restaurants - (Net-Austria)  
The Ritz-Carlton - Vienna  
Römerbad Thermen - Bad Kleinkirchheim  
Schlosshotel Obermayernhofen - Sebersdorf

## AZERBAIJAN

Golf Academy - Baku  
Gumush Residence - Baku

## BOSNIA

Hotel Mavis - Orasje

## BULGARIA

Este Fitness & spa - Sofia  
Hotel Kempinski Grand Arena - Bansko

## CARIBBEAN

Hyatt Hotel - Aruba  
Marigot Bay Hotel and Resort - St. Lucia

## CYPRUS

Calypso Hotel - Paphos  
Holiday Villas - Paphos

## CROATIA

Berkeley Hotel - Dubrovnik  
Café Bar Tango - Osijek  
Grand Hotel Slavia - Baska Voda  
Café Bar Tango - Osijek  
Grand Hotel Slavia - Baska Voda  
Hotel Bellevue - Malj Losinj  
Hotel San Fior - Rabac Istra  
Hotel Luna - Porec Istra  
Hotel Sol Coral - Umag  
Hotel Tamaris - Porec  
Hotel Meteor -Rovinj  
Hotel Albatros - Porec  
Hotel Riviera - Porec

## DUBAI

Four Seasons Hotel And Resort - Dubai  
Jal Tower Hotel / Restaurant - Dubai  
Pullmann Hotel - Dubai  
The Palace Hotel - Dubai

## FRANCE

Grand Hotel du Domaine de Divonne - Divonne  
Les Chalets du Soleil - Val Thorens  
Hotel de Paris - Monaco Montecarlo  
Hotel Mercure - Lille  
Hotel du Domaine les Terrasses du Bailli - Le Rayon Canadel  
Office de Tourisme - St. Cyprien

## GEORGIA

Hotel Ambassadori - Tblisi

## GERMANY

Aspria Club - Uhlenhorst-Hamburg  
Auebad - Kassel  
Bar Montraw - Berlino  
Chalet Kitzbuehel  
Emser Therme - Bad Ems  
Häcker's Grand Hotel - Bad Ems  
Haus Meeresrauschen - Insel Rügen  
Haus Meeresbrise - Insel Rügen  
Hotel Birkenhof - Neunburg v. Wald  
Hotel Fürstenhof - Bad Bertrich  
Hotel Meerlust - Ostseebad Zingst  
Hotel Rübezahl - Schwangau-Horn  
Hotel zur Post - Lohfelden  
Kiss Salis Therme - Bad Kissingen  
Landhotel All Gauer Hof - Wolfegg Altann  
Microsoft Deutschland - Munchen  
Mineralbad Leutze - Stuttgart  
Seehotel Binztherme - Ostseebad Binz  
Seehotel Grossherzog Von Mecklenburg - Boltenhagen  
Swisshotel Neuss - Neuss  
Thermen Hotel - Bad Kissingen  
Travel Charme Hotel - Binz  
Westin - Leipzig

## GREECE

Hotel Glicoris Beach - Pythagorio - Samos  
Restaurant AMI - Loutraki  
Ristorante Paradiso - Halandri  
Hotel Orion - Santorini  
Hotel Antinea - Santorini  
Hotel Nefels - Santorini  
Restaurant Ami - Korinthos  
Restaurants Pizza Hut - Athens / Net

## JORDAN

Fairmont Hotel - Amman

## HUNGARY

Grand Hotel Anna - Balatonfured  
Sydney Hotel Apt - Budapest  
Le Grand Cafeteria - Budapest

## KAZAKHSTAN

Rixos Khadisha Hotel - Shimkent

## MOROCCO

16 Café Restaurant Glacier - Marrakech

## MALDIVES

Four Seasons Resorts Maldives - Baa Atoll

## PORTUGAL

Hotel Dona Ines - Coimbra

## RUSSIA

Hyatt Regency Resort - Moscow  
Restaurant Il Pittore - Moscow  
Spa Golden Mile - Moscow

## SLOVAKIA

Crowne Plaza Hotel - Bratislava  
Camouflage Reastaurant - Bratislava

## SLOVENJA

Rimske Therme - Rimske

## SPAIN

Ritz-Carlton Abama Hotel - Guia de Isora - Tenerife  
Hotel Reserva del Higueron - Benalmadena - Malaga Club del Golf Fuente Del Alamo - Fuente del Alamo-Murcia  
Sol Moyan Suites - Puerto De Mogan - Las Palams - Gran Canaria

## SWITZERLAND

Grand Hotel Victoria - Jungfrau - Interlaken  
Hotel Carcani - Ascona  
Hotel Touring - Naters  
Lido Conca D'oro - Lugano  
Unique Hotel Dom - Saas-Fee  
Solbadhotel - Sigriswil

## UNITED KINGDOM

The Scarlet Hotel - Newquay, Cornwall

## UKRAINE

Il Decameron - Odessa

## U.S.A.

Fairmont Hotel Maui - Hawaii  
Hilton Garden Inn - Waikiki, Hawaii  
Hotel Radisson - Yuma, Texas  
Hotel Sheraton Waikiki - Hawaii  
Kimpton Hotel - Wilshire - Los Angeles  
Marriott Resort and Spa - Waikiki, Hawaii  
One Bal Harbour Resort and Spa - Miami, Fl  
Sonesta Hotel - Coral Gables, Flo.  
The Royal Hawaiian Waikiki - Hawaii  
The Wit - Chicago, Mi.  
Ritz Carlton Key Biscayne - Miami, Fl  
River Parc Residence - Port Imperial, Weehawken, Nj  
Sistina Restaurant - New York

## CREDITS

---

designers:

**GV Plazzogna**  
**Roberto Papparotto**  
**Studio Balutto Associati**  
**Santiago Sevillano**  
**Technical Emotions**  
**Antonio De Marco**  
**Simone Fanciullacci**  
**Studio Tecnico Roberti**

art direction e styling:  
**o2 STUDIO**

photo:  
**STUDIO ROCCI**

graphics:  
**TAGLIA5**

print:  
**LA GRAFICA FAGGIAN**

**2019**



Roberti®

---

ROBERTI RATTAN srl  
Via Madonna di Loreto, 53  
31020 Corbanese di Tarzo (TV) - ITALY  
tel. +39 0438 933022 | fax +39 0438 933005

[info@robertirattan.com](mailto:info@robertirattan.com)  
[www.robertirattan.com](http://www.robertirattan.com)