

Ca  
Pri  
Ci



Timeless Interiors





Timeless Interiors





## Zona Giorno

credenza	.....	06	.....	<i>cupboard</i>
vetrinetta	.....	24	.....	<i>glass showcase</i>
mobile bar	.....	30	.....	<i>mobile bar</i>
consolle	.....	31	.....	<i>consolle</i>
etagere	.....	48	.....	<i>etagere</i>
portasedie	.....	52	.....	<i>chair holder</i>
mobile tv	.....	53	.....	<i>tv table</i>
tavolo	.....	56	.....	<i>table</i>
tavolino	.....	84	.....	<i>coffee table</i>

## Living Room

## Zona Studio

libreria	.....	108	.....	<i>bookcase</i>
scrivania	.....	116	.....	<i>desk</i>
bureau	.....	124	.....	<i>bureau</i>
tavolo riunioni	.....	126	.....	<i>meeting table</i>

## Studio

## Zona Notte

letto	.....	130	.....	<i>bed</i>
comodino	.....	154	.....	<i>bedside table</i>
settimanale	.....	164	.....	<i>tallboy</i>
comò	.....	170	.....	<i>chest of drawers</i>
specchiera	.....	184	.....	<i>mirror</i>
armadio	.....	194	.....	<i>wardarobe</i>
mobile toilette	.....	196	.....	<i>mobile toilette</i>

## Bedroom

## Seduta

sedia	.....	200	.....	<i>chair</i>
sgabello	.....	234	.....	<i>stool</i>
poltrona	.....	246	.....	<i>armchair</i>
panchetta	.....	256	.....	<i>bench</i>
divano	.....	262	.....	<i>sofa</i>

## Seat

## Finiture

legno	.....	270	.....	<i>wood</i>
laccato	.....	271	.....	<i>laquered</i>
pelle	.....	272	.....	<i>leather</i>
stoffa	.....	273	.....	<i>fabric</i>

## Finishes

living room  
**zona giorno**







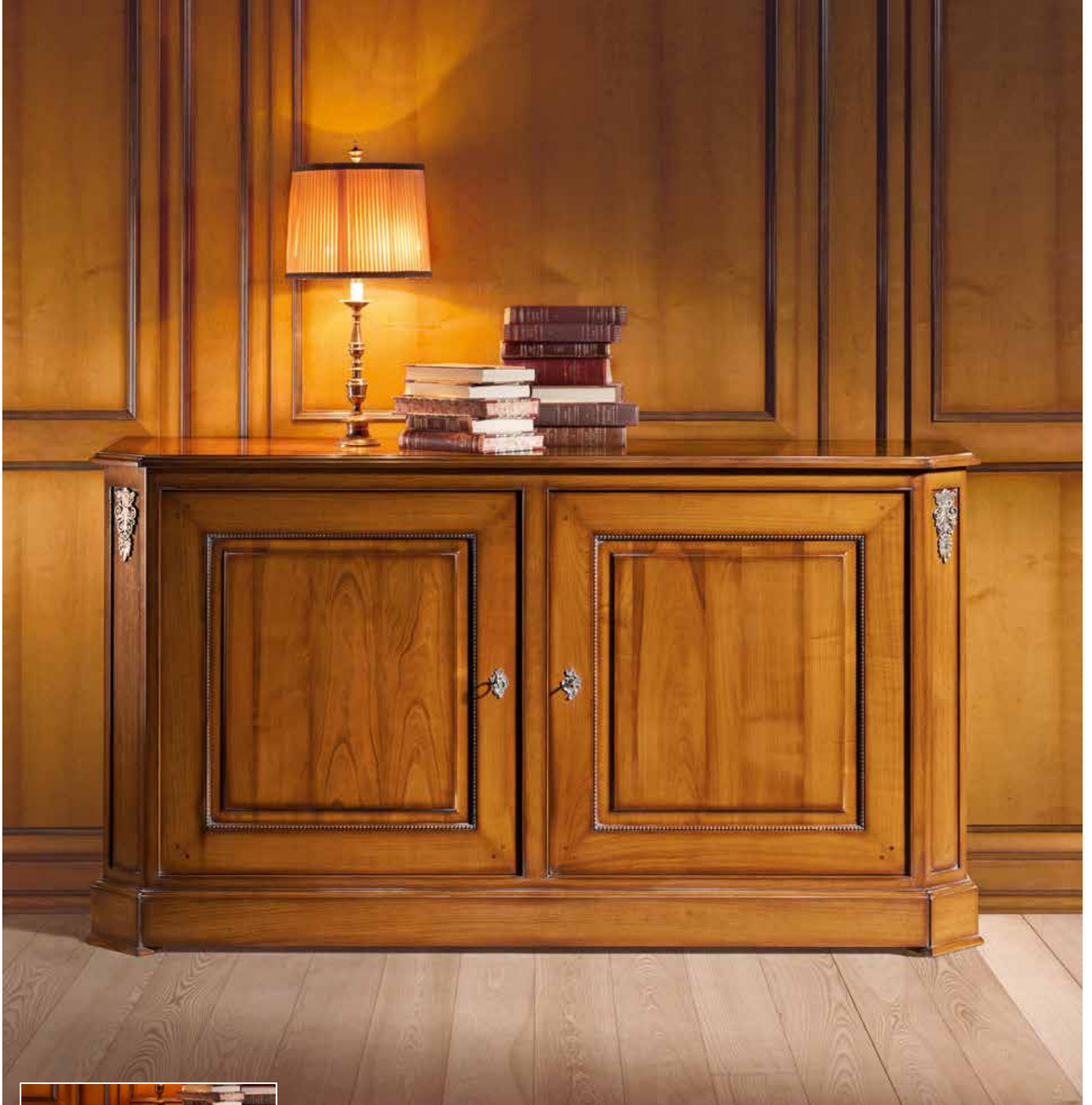

## CVA001

Credenza in ciliegio/rovere con top riquadrato. All'interno 2 cassetti + 2 ripiani con scalette, lo spazio è diviso da un elemento centrale. Le ante hanno una decorazione a forma di perline sulla cornice ed il pannello bugnato massiccio, schienale intelaiato in massello di frassino. Dimensioni totali L 196 x P 57 x H 107cm

*Sideboard in cherry/light oak with squared top. Inside 2 drawers + 2 shelves with steps, the space is divided by a central panel. The doors are decorated with pearl-shaped carvings around the frame and with a solid ashlar-worked panel, the framed back panel is in ash blockwood. Total dimensions (W) 196, (D) 57, (H) 107 cm*



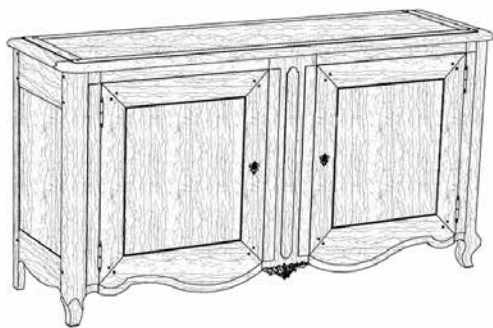

## CVA002

Credenza in ciliegio con 2 ante sagomate nella parte bassa ed all'interno 2 ripiani regolabili. Top riquadrato e prezioso decoro in ottone sotto il montante centrale, schienale intelaiato in massello di frassino. Dimensioni totali L 191 x P 56 x H 101 cm

*Sideboard in cherry with 2 doors shaped towards the bottom and inside 2 adjustable shelves. Squared top with precious brass decoration below the central support, framed back panel in ash blockwood. Total dimensions (W) 191, (D) 56, (H) 101 cm*



## CVA003

Credenza Direttorio in ciliegio con 2 ante e 2 cassetti ed all'interno 1 divisorio centrale e 2 ripiani in frassino regolabili. Top riquadrato, schienale intelaiato in massello di frassino.  
Dimensioni totali L 124 x P 45 x H 100 cm

*Director's sideboard in cherry with 2 doors and 2 drawers and inside 1 central dividing pannel and 2 adjustable shelves in ash. Squared top, framed back pannel in ash blockwood.  
Total dimensions (W) 124, (D) 45, (H) 100 cm*



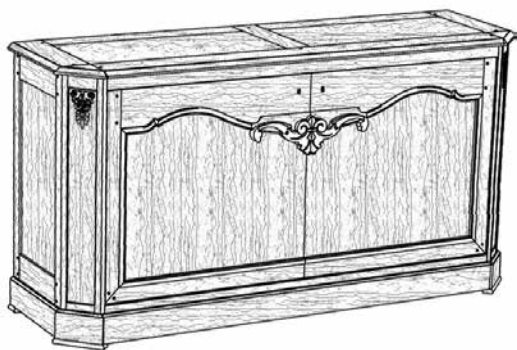

## CVA018

Credenza 2 ante in ciliegio/rovere. All'interno 1 divisorio centrale, 2 cassetti e 2 ripiani regolabili. Top riquadrato a disegno, montanti inclinati a 45° con decoro in ottone e prezioso intaglio fatto a mano nella parte centrale. Dimensioni totali L 196 x P 57 x H 107 cm

*Sideboard with 2 doors in cherry wood/light oak. Inside 1 central dividing panel, 2 drawers and 2 adjustable shelves. Squared top with designs, supports inclined at 45° with decoration in brass and precious hand made inlay work in the centre. Total dimensions (W) 196, (D) 57, (H) 107 cm*

## CVA004

Credenza Direttorio in ciliegio, con due ante e due cassetti ed un divisorio interno centrale e due ripiani in frassino regolabili, schienale intelaiato in massello di frassino. Dimensioni totali L 150 x P 50 x H 95 cm

*Director's sideboard in cherry with two doors and two drawers and one central dividing inner pannel and two adjustable shelves in ash, framed back in ash blockwood. Total dimensions (W) 150, (D) 50, (H) 95 cm*



## CVA005

Credenza Direttorio in ciliegio, con tre ante, tre cassetti e due divisori interni centrali e tre ripiani in frassino regolabili, schienale intelaiato in massello di frassino. Dimensioni totali L 200 x P 50 x H 95 cm

*Director's sideboard in cherry with three doors and three drawers and two central dividing inner pannels and three adjustable shelves in ash, framed back in ash blockwood. Total dimensions (W) 200, (D) 50, (H) 95 cm*



## CVC004

Vetrina Direttorio in ciliegio, con due ripiani in vetro e due in legno. Vetri molati sulle ante e sui finachi. Dimensioni totali L 136 x P 46 x H 200 cm

*Director's showcase in cherry with 2 glass shelves and 2 in wood. The glass is bevelled on the doors and sides. Total dimensions (W) 136, (D) 46, (H) 200 cm*

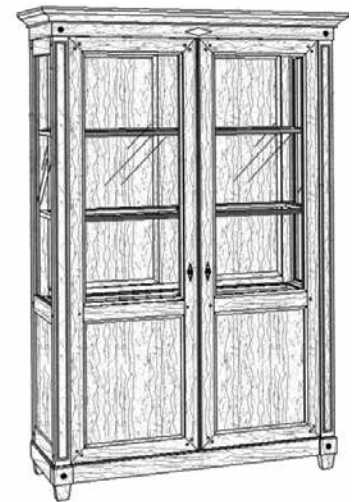







## CVA006

Credenza in ciliegio, con due ante, un divisorio interno centrale e due ripiani regolabili a scaletta; schienale intelaiato in massello di frassino.  
Dimensioni totali L 157 x P 52 x H 96 cm

*Sideboard in cherry wood with two doors, a central dividing pannel inside and two adjustable "step" shelves; framed back-pannel in ash blockwood.  
Total dimensions (W) 157, (D) 52, (H) 96 cm*

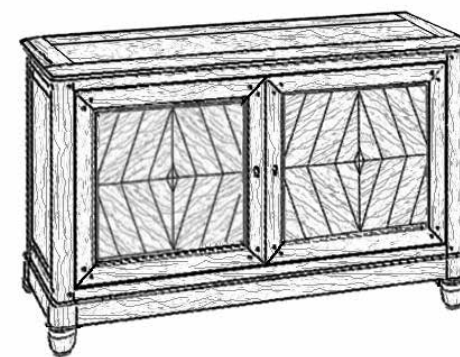

## CVA022

Credenza in ciliegio, con due ante e due cassetti, un divisorio interno centrale e due ripiani regolabili a scaletta; schienale intelaiato in massello di frassino.  
Dimensioni totali L 157 x P 52 x H 96 cm

*Sideboard in cherry wood with two doors and two drawers, with a central dividing pannel inside and two adjustable "step" shelves; framed back-pannel in ash blockwood. Total dimensions (W) 157, (D) 52, (H) 96 cm*

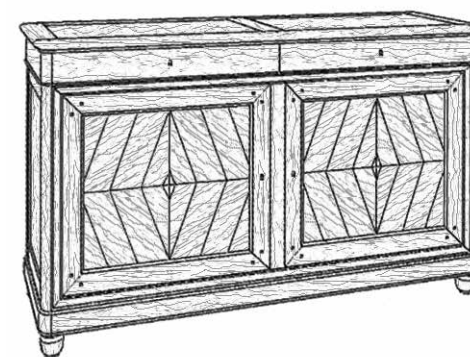





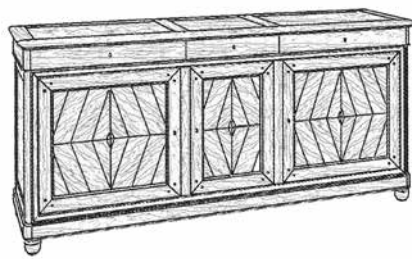
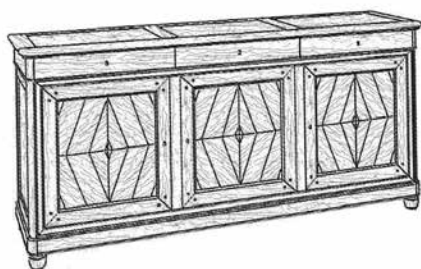
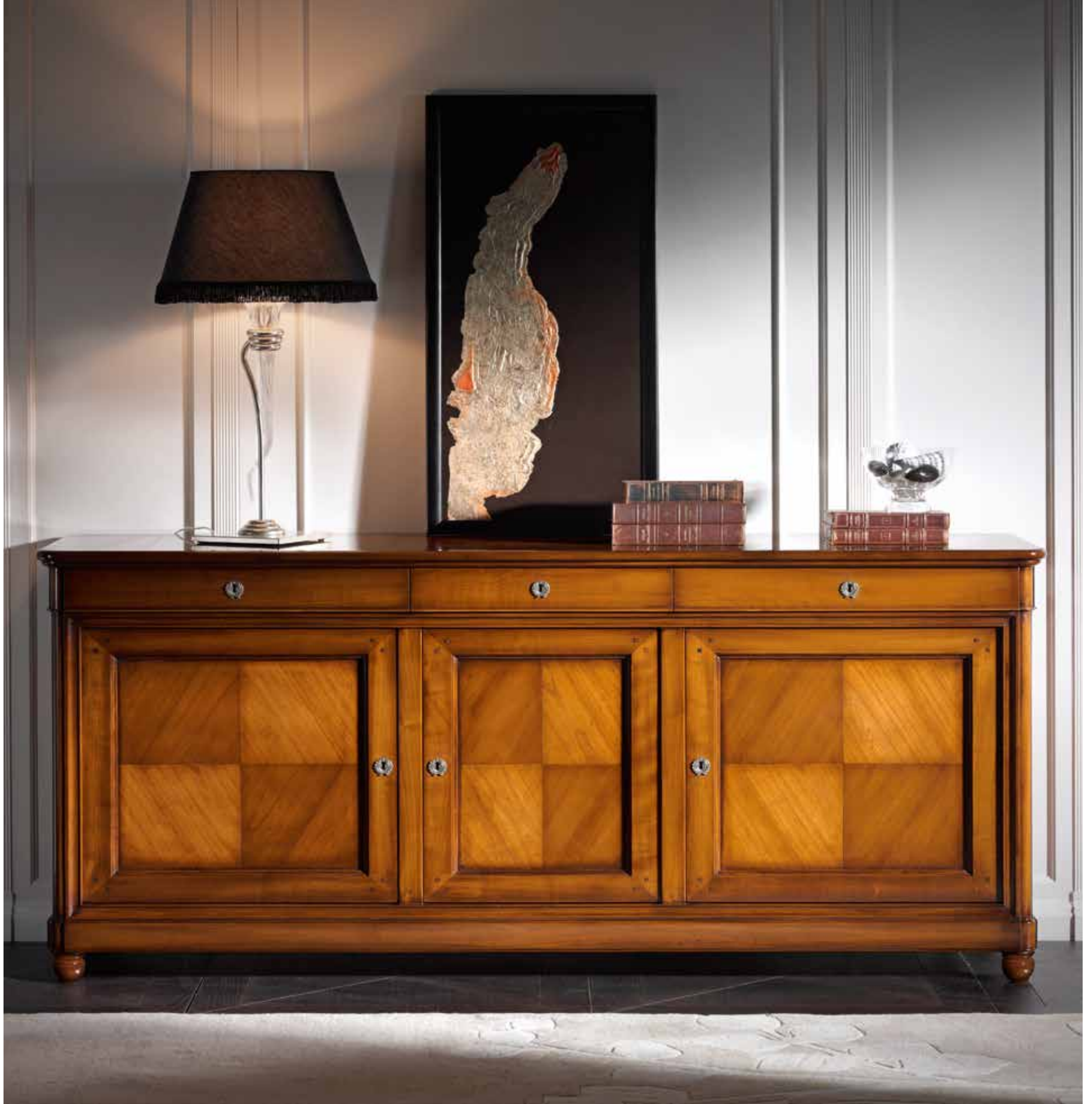

## CVA007

Credenza in ciliegio con 3 ante e 3 cassetti, anta centrale più stretta, 2 divisori centrali e 3 ripiani regolabili a scaletta; schienale intelaiato in massello di frassino. Dimensioni totali L 208,5 x P. 52 x H. 96 cm

*Sideboard in cherry wood with 3 doors and 3 drawers, narrower central door, 2 dividing central pannels and 3 adjustable "step" shelves; framed back-pannel in ash blockwood. Total dimensions (W) 208.5, (D) 52, (H) 96 cm*

## CVA024

Credenza in ciliegio con 3 ante e 3 cassetti, 2 divisori centrali e 3 ripiani regolabili a scaletta; schienale intelaiato in massello di frassino. Dimensioni totali L 203 x P 52 x H 96 cm

*Sideboard in cherry wood with 3 doors and 3 drawers, 2 dividing central pannels and 3 adjustable "step" shelves; framed back-pannel in ash blockwood. Total dimensions (W) 203, (D) 52, (H) 96 cm*

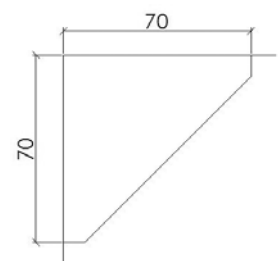
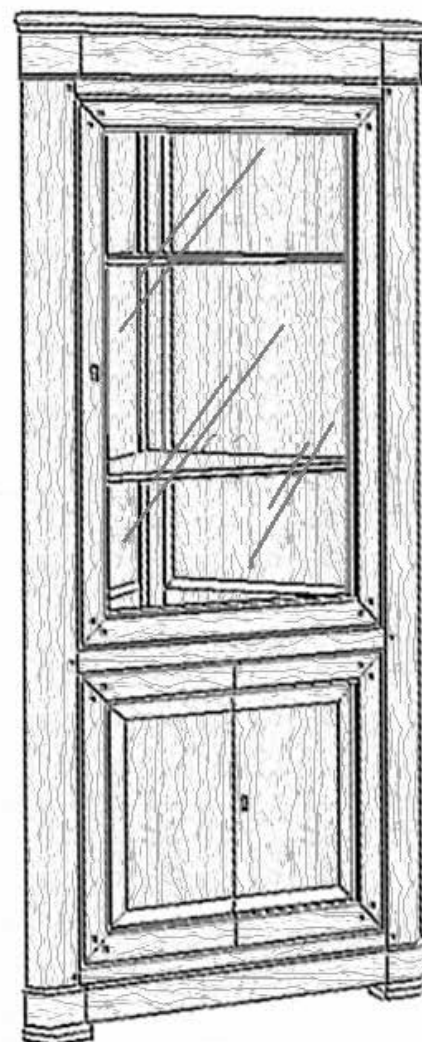

## CVA008

Angoliera in ciliegio con anta a vetro superiore e 2 ante inferiori con pannello bugnato. All'interno, nella parte bassa, 1 ripiano. Nella parte alta un'anta con vetro molato, 2 ripiani in legno di frassino regolabili in altezza e schienale intelaiato in massello di frassino.  
Dimensioni totali L 70 x P 70 x H 221 cm

*Cherry-wood cornerpiece with top door in glass and 2 bottom doors with ashlar-worked pannels. Inside, in the lower part, 1 shelf. At the top a door with beveled glass, 2 wooden shelves in ash of adjustable height and framed back pannel in ash blockwood.  
Total dimensions (W) 70, (D) 70, (H) 221 cm*



## CVA025

Credenza 2 ante e 3 cassetti in ciliegio/rovere. All'interno 1 divisorio centrale e 2 ripiani. Top riquadrato a disegno, con scanalature nella parte centrale.  
Dimensioni totali L 185 x P 55 x H 101 cm

*Cupboard with two doors and three drawers in cherry/oak wood. Inside one central divider and two shelves. Framed top to design, with grooves in the central part. Total dimensions (W) 185 x (D) 55 x (H) 101cm*

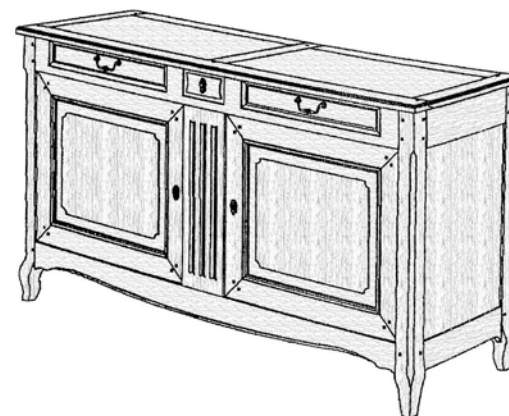

## CVA026

Credenza 3 ante e 3 cassetti in ciliegio/rovere. All'interno 1 divisorio centrale e 2 ripiani. Top riquadrato a disegno, con scanalature nella parte centrale.  
Dimensioni totali L 210 x P 55 x H 101 cm

*Cupboard with three doors and three drawers in cherry/oak wood. Inside one central divider and two shelves. Framed top to design, with grooves in the central part. Total dimensions (W) 210 x (D) 55 x (H) 101cm*

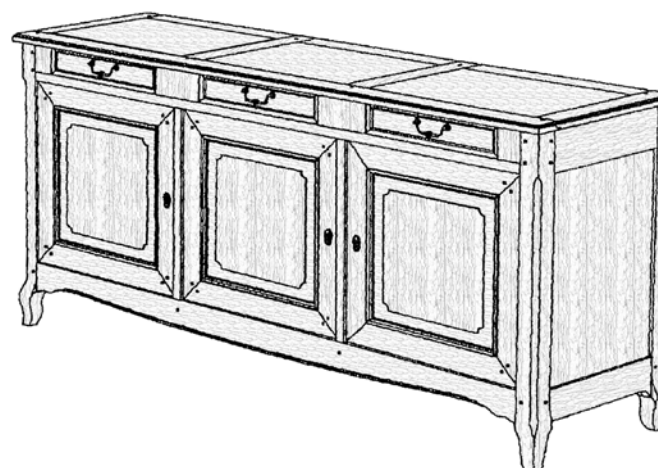



## CVA019

Credenza 2 ante in misto legno e multistrato tanganica, all'interno un ripiano non regolabile. Prezioso decoro in ottone.  
Dimensioni totali L 142 x P 44 x H 80 cm

*Sideboard 2 doors in mixed wood and multilayer tanganyika, inside a non-adjustable shelf. Precious decoration in brass.  
Total dimensions (W) 142, (D) 44, (H) 80 cm*



## CVA020

Credenza 2 ante in misto legno e multistrato tanganica, all'interno un ripiano non regolabile. Prezioso decoro in ottone.  
Dimensioni totali L 185 x P 55 x H 105 cm

*Sideboard 2 doors in mixed wood and multilayer tanganyika, inside a non-adjustable shelf. Precious decoration in brass.  
Total dimensions (W) 185, (D) 55, (H) 105 cm*









## CVA019

Credenza due ante in misto legno e multistrato tanganica, all'interno un ripiano non regolabile. Prezioso decoro in ottone.  
Dimensioni totali  
L 142 x P 44 x H 80 cm

*Sideboard 2 doors in mixed wood and multilayer tanganyika, inside a non-adjustable shelf. Precious decoration in brass.  
Total dimensions  
(W) 142, (D) 44, (H) 80cm*

## CVA020

Credenza 2 ante in misto legno e multistrato tanganica, all'interno un ripiano non regolabile. Prezioso decoro in ottone.  
Dimensioni totali L 185 x P 55 x H 105 cm

*Sideboard 2 doors in mixed wood and multilayer tanganyika, inside a non-adjustable shelf. Precious decoration in brass. Total dimensions  
(W) 185, (D) 55, (H) 105cm*



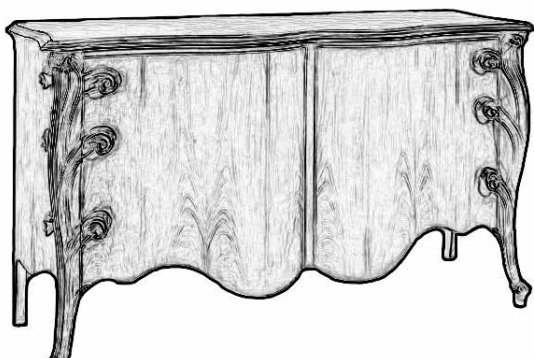
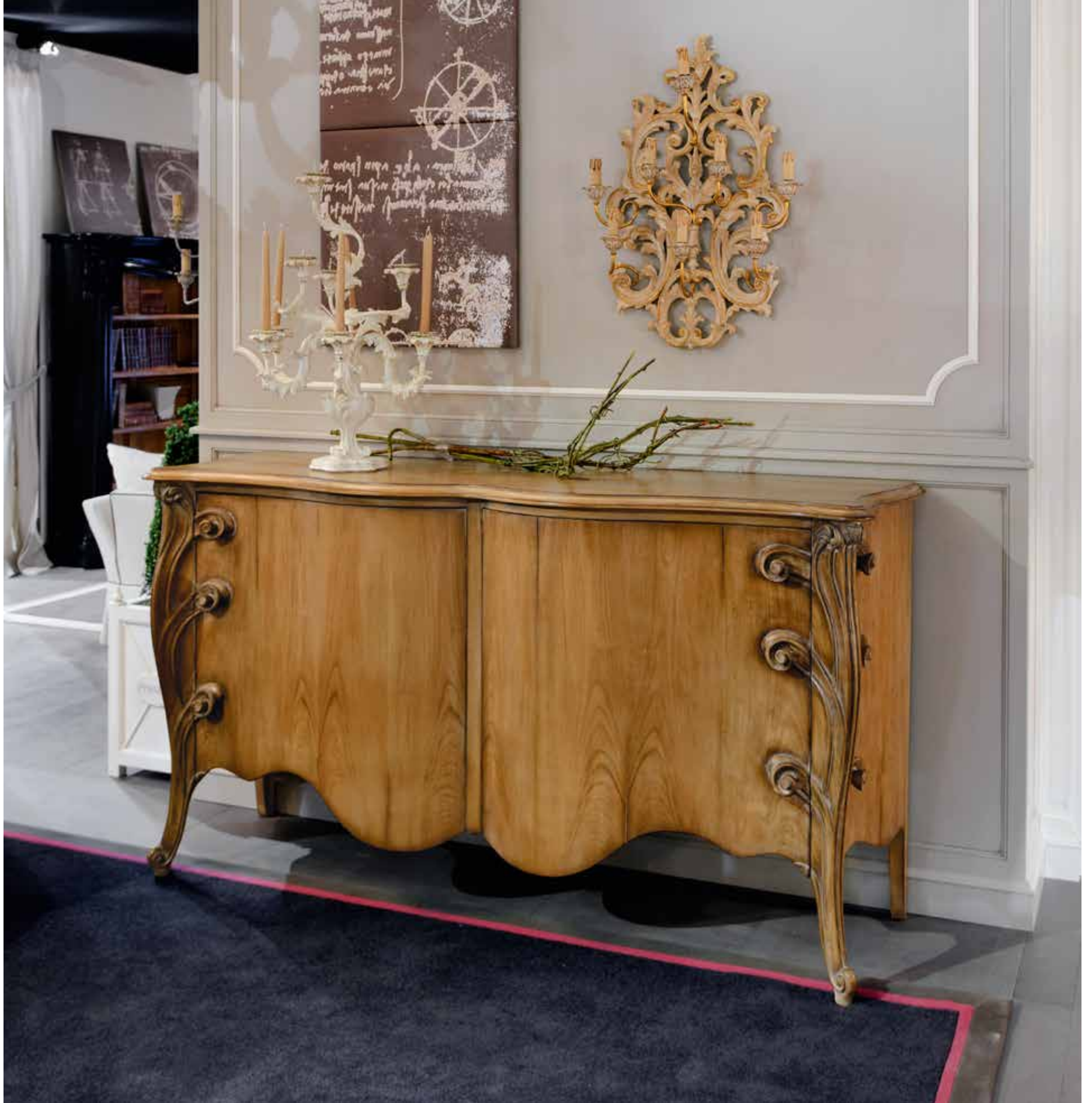

## CVA037

Credenza in ciliegio sagomata 2 ante. Montanti e maniglie intagliati a mano secondo le antiche tradizioni dell'ebanisteria veneta.

Dimensioni totali L 190 x P 58 x H 104 cm

*Contoured cupboard in cherry wood with two doors. Uprights and handles carved by hand in keeping with the ancient traditions of Venetian cabinet makers. Total dimensions (W) 190 x (D) 58 x (H) 104cm*











## CVC006

Credenza con alzata in ciliegio, 2 ante in vetro molato e 2 ante in legno, 4 ripiani in legno ed un divisorio nella parte alta, 2 ripiani ed un divisorio nella parte bassa. Dimensioni totali L 161 x P 52 x H 226 cm

*Sideboard in two parts, top and bottom in cherry, in the top part 2 grind glass doors and 2 wooden doors, 4 wooden shelves and a dividing pannel, 2 shelves and a dividing pannel, in the bottom part. Total dimensions (W) 161, (D) 52, (H) 226 cm*

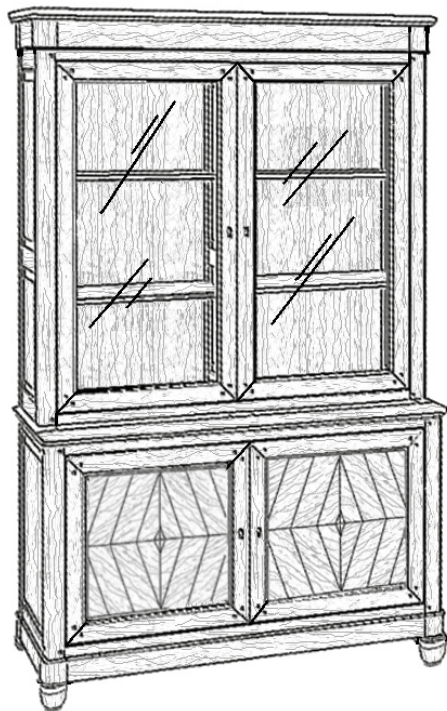

## CVC007

Vetrina in ciliegio, 2 ripiani in vetro e 2 ripiani in legno, con vetri molati sulle ante e sui fianchi. Impiallacciatura a spina di pesce sulle ante. Dimensioni totali L 134 x P 44 x H 200 cm

*Show-case in cherry, 2 glass shelves and 2 wooden shelves, with bevelled glass doors and side pannels. Fish-bone veneer on the doors. Total dimensions (W) 134, (D) 44, (H) 200 cm*

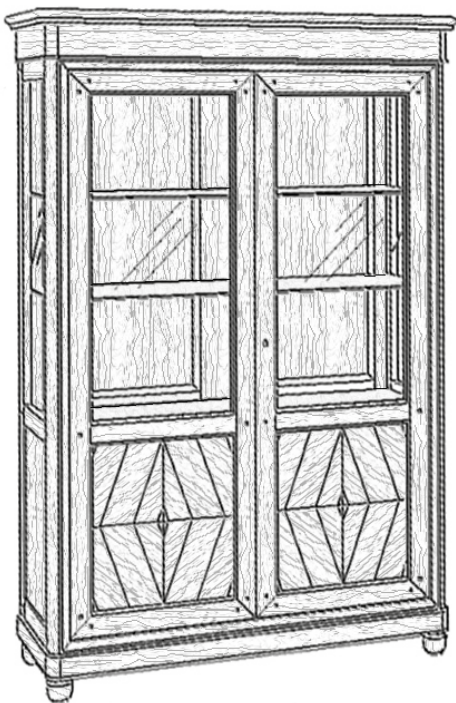





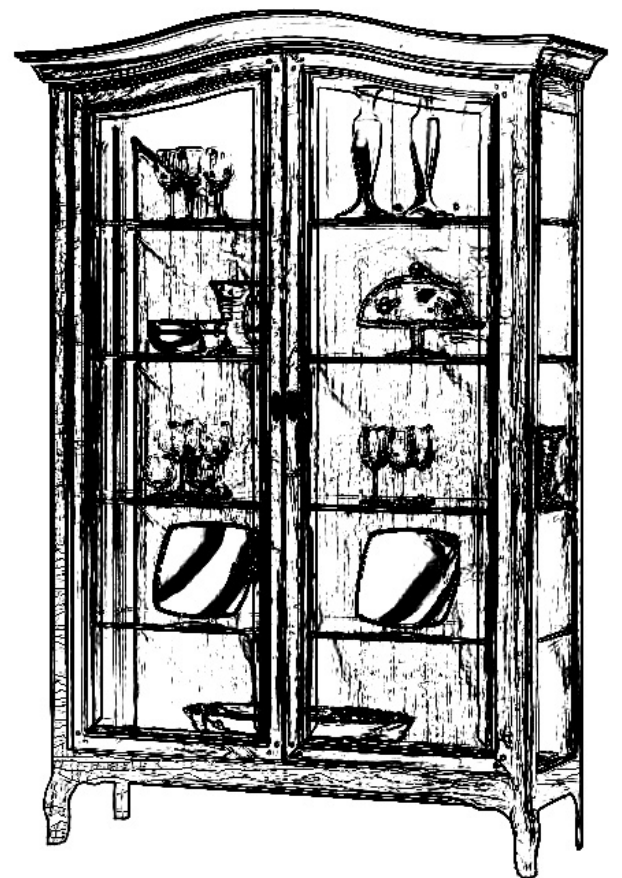

## CVC019

Vetrina in ciliegio/rovere con cappello sagomato, con 2 ante in vetro e all'interno 4 ripiani in vetro spostabili su scaletta in ottone. Fianchi in vetro.  
Dimensioni totali L 135 x P 46 x H 200 cm

*Display cabinet in cherry / oak wood with contoured cornice moulding, with two glass doors and four adjustable glass shelves on brass racks. Glass side panels.  
Total dimensions (W) 135 x (D) 46 x (H) 200cm*





## CVC035

Vetrina in ciliegio con 2 ante legno scorrevoli e 2 ante vetro scorrevoli.  
All'interno 4 ripiani in vetro regolabili. Schienale dogato.  
Dimensioni totali L 207 x P 45 x H 158 cm

*Display cabinet in cherry wood with two sliding wood doors and two sliding glass doors. Inside four adjustable glass shelves. Staved back panel. Total dimensions (W) 207 x (D) 45 x (H) 158cm*



## CVC018

Vetrina in ciliegio/rovere con 2 ante in vetro con all'interno 4 ripiani in vetro spostabili su scaletta in ottone. Fianchi in vetro, schienale in frassino massiccio intelaiato e prezioso intaglio fatto a mano nella parte superiore delle ante. Dimensioni totali L 179 x P 56 x H 220 cm

*Showcase in cherry/light oak with 2 glass doors, and inside 4 removable self glass with steps in brass. Sides in glass, backing in solid framed ash, with precious hand made inlay at the top of the doors.*  
*Total dimensions (W) 179, (D) 56, (H) 220 cm*





## CVC037

Vetrina in ciliegio con 3 ante in vetro rientranti e con 2 cassetti inferiori.  
Dimensioni totali L 140 x P 42 x H 139 cm

*Display cabinet in cherry wood with three hidden glass doors and two lower drawers. Total dimensions (W) 140 x (D) 42 x (H) 139cm*





## CVA011

Mobile bar in ciliegio con schienale e fondo a specchio. Tiretto estraibile con vassoio asportabile. Dimensioni totali L 115 x P 54 x H 141 cm

*Bar unit in cherry wood with mirror on back pannel. Extractable top with removable tray. Total dimensions (W) 115, (D) 54, (H) 141 cm*





## CVB010

Consolle in ciliegio con cassetto sagomato nella parte inferiore e prezioso intaglio fatto a mano. Top e ripiano fisso riquadrati. Dimensioni totali L 141 x P 50 x H 85 cm

*Console in cherry with bombé shape in the lower part of the drawer and precious hand made inlay. Top and fixed, squared shelves. Total dimensions(W) 141, (D) 50, (H) 85 cm*

## CVB013

Consolle in ciliegio con cassetto sagomato nella parte inferiore e prezioso intaglio fatto a mano. Top e ripiano fisso riquadrati. Dimensioni totali L 197 x P 50 x H 85 cm

*Console in cherry with bombé shape in the lower part of the drawer and precious hand made inlay. Top and fixed, squared shelves. Total dimensions(W) 197, (D) 50, (H) 85 cm*



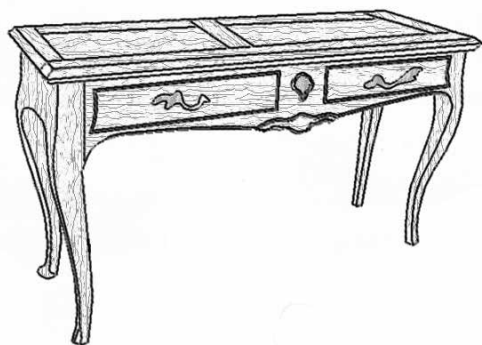

## CVB011

Consolle in ciliegio con 2 cassetti e fregi in ottone.  
Top riquadrato a disegno ed intaglio fatto a mano nella parte inferiore centrale. Dimensioni totali L 141 x P 45 x H 80 cm

*Console in cherry with 2 drawers and embellishments in brass.  
Squared top with design and hand made inlay in the lower central part.  
Total dimensions (W) 141, (D) 45, (H) 80 cm*



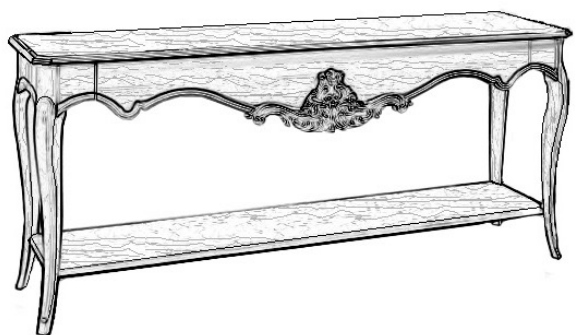

## CVB024

Consolle in ciliegio con cassetto sagomato nella parte inferiore e prezioso intaglio fatto a mano. Dimensioni totali L 197 x 50 x H 85 cm

*Contoured console in cherry wood with a drawer at the lower part and beautiful hand carved. Total dimensions (W) 197 x (D) 50 x (H) 85cm*

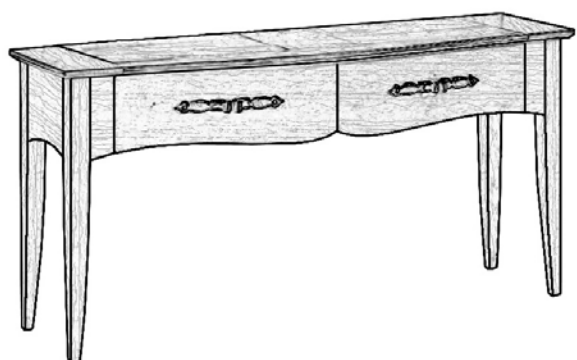

## CVB025

Consolle sagomata in ciliegio con 2 cassetti.  
Dimensioni totali L 145 x P 42 x H 70 cm

*Console in cherry wood with two drawers.  
Total dimensions (W) 145 x (D) 42 x (H) 70cm*



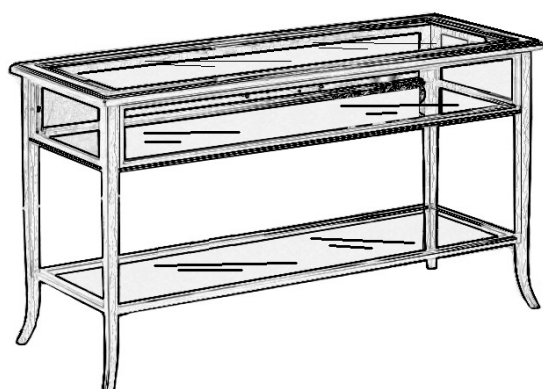

## **CVB028**

Consolle in ciliegio con piano in vetro e perline decorative in ottone.  
Dimensioni totali L 125 x P 43 x H 66,5 cm

*Console in cherry wood with glass top and decorative brass beads.  
Total dimensions (W) 125 x (D) 43 x (H) 66,5cm*

## CVB005

Consolle in ciliegio/rovere con 2 cassetti. Struttura in rovere con piano parchettato in rovere ed inserti in ciliegio. Dimensioni totali L 122 x P 46 x H 76 cm

*Console table in cherry/light oak with 2 drawers. Structure in light oak with parquetted top in light oak and inserts in cherry. Total dimensions (W) 122, (D) 46, (H) 76 cm*







## TCV009

Consolle in ciliegio con sportello apribile sul lato lungo. Vetri molati sul piano superiore e lungo tutto il perimetro. Preziosi fregi in ottone sulle gambe. Dimensioni totali L 70 x P 40 x H 77 cm

*Console in cherry wood with opening doors on the long side. Bevelled glass for the top and all around the edges. Precious embellishments in brass on the legs. Total dimensions (W) 70, (D) 40, (H) 77 cm*



## TCV010

Consolle in ciliegio con sportello apribile sul lato lungo. Vetri molati sul piano superiore e lungo tutto il perimetro. Preziosi fregi in ottone sulle gambe. Dimensioni totali L 110 x P 40 x H 77 cm

*Console in cherry wood with opening doors on the long side. Bevelled glass for the top and all around the edges. Precious embellishments in brass on the legs. Total dimensions (W) 110, (D) 40, (H) 77 cm*



## TCV011

Consolle in ciliegio con sportello apribile sul lato lungo. Vetri molati sul piano superiore e lungo tutto il perimetro. Preziosi fregi in ottone sulle gambe. Dimensioni totali L 140 x P 40 x H 77 cm

*Console in cherry wood with opening doors on the long side. Bevelled glass for the top and all around the edges. Precious embellishments in brass on the legs. Total dimensions (W) 140, (D) 40, (H) 77 cm*







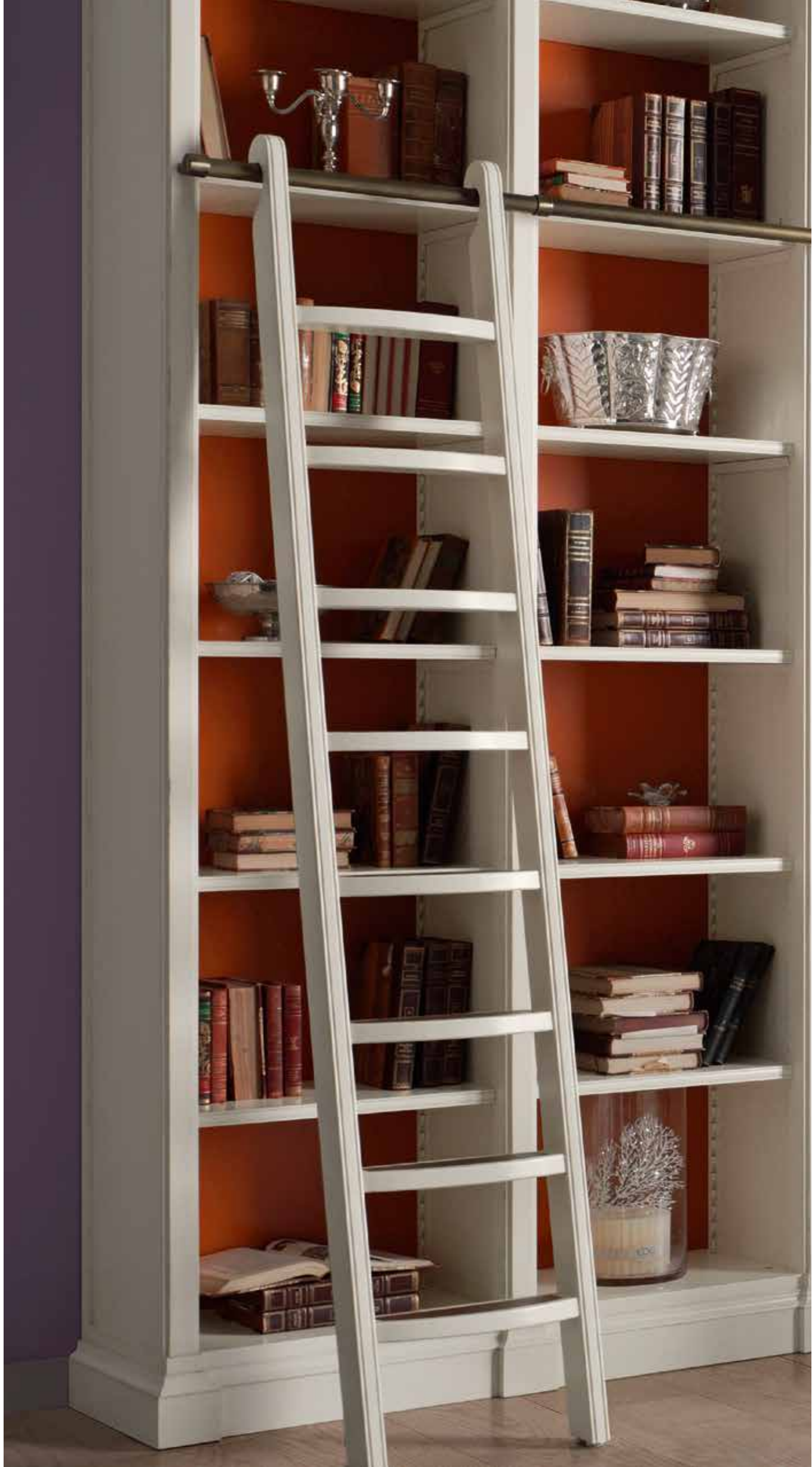









## CVB001

Consolle a mezzaluna in ciliegio con 2 allunghe da 43 cm (non cinturate) e puntali in ottone. Piano top riquadrato come da disegno.  
Dimensioni totali L 110 x P 55 x H 79 cm

*Crescent console in cherry wood with two extensions measuring 43 cm (not sprung) and brass ends. Framed table top box as in design.  
Total dimensions (W) 110 x (D) 55 x (H) 79cm*



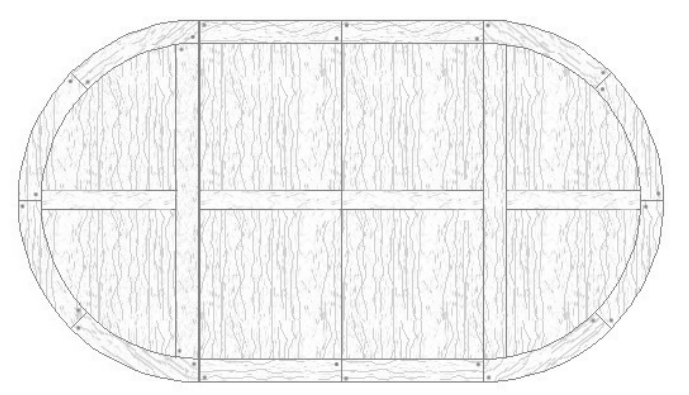
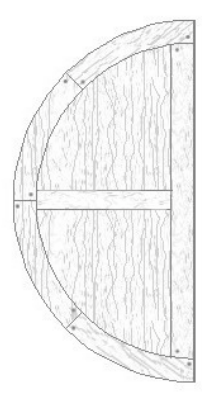



## CVB002

Consolle in ciliegio con cassetto, top riquadrato e ripiano fisso nella parte inferiore. Dimensioni totali L 90 x P 37 x H 81 cm

*Console table in cherry with drawer, squared top and fixed shelf in the lower part. Total dimensions (W) 90, (D) 37, (H) 81 cm*



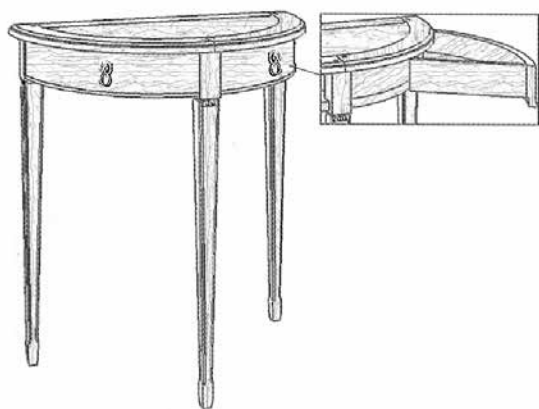

## CVB003

Consolle in ciliegio con 2 tiretti. Top riquadrato e tiretti con cerniere alle estremità. Dimensioni totali L 70 x P 36 x H 75 cm

*Console table in cherry wood with 2 little drawers. Squared top and drawers with hinges at the ends. Total dimensions (W) 70, (D) 36, (H) 75 cm*

## CVB032

Consolle in faggio.  
Dimensioni totali L 130 x P 42 x H 84 cm

*Console in beech wood.  
Total dimensions (W) 130 x (D) 42 x (H) 84cm*

## CV0032

Specchiera in faggio.  
Dimensioni totali L 102 x P 4 x H 160 cm

*Mirror in beech wood.  
Total dimensions (W) 102 x (D) 4 x (H) 160cm*







## CVA013

Etagere in ciliegio piccola. Dimensioni totali L 41 x P 29 x H 90 cm

*Small etagere in cherry wood. Total dimensions (W) 41, (D) 29, (H) 90 cm*

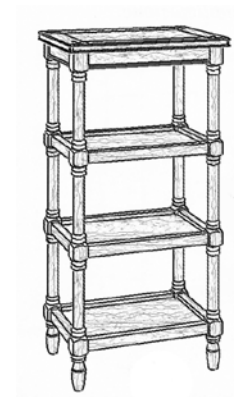

## CVA021

Etagere in ciliegio media.  
Dimensioni totali L 61 x P 29 x H 90 cm

*Medium etagere in cherry wood.  
Total dimensions (W) 61, (D) 29, (H) 90 cm*



## CVA012

Etagere in ciliegio grande.  
Dimensioni totali L 81 x P 29 x H 90 cm

*Big etagere in cherry wood.  
Total dimensions (W) 81 (D) 29, (H) 90 cm*







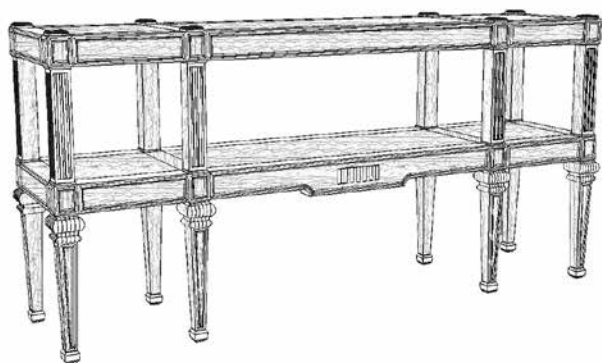

## CVB004

Etagere in ciliegio massiccio a 2 piani con preziose lavorazioni fatte a mano sulle gambe. Dimensioni totali L 163 x P 41 x H 79 cm

*Etagere in solid cherry wood with 2 shelves and precious hand made decorations on the legs. Total dimensions (W) 163, (D) 41, (H) 79 cm*



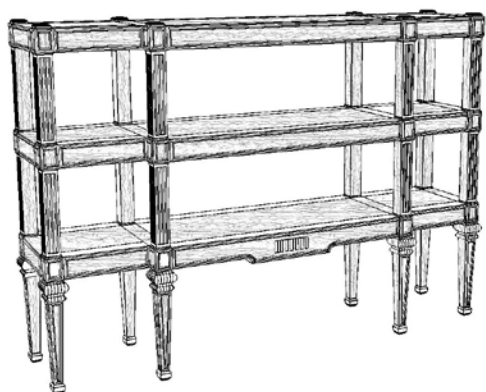

## CVB012

Etagere in ciliegio massiccio a 3 piani con preziose lavorazioni fatte a mano sulle gambe. Dimensioni totali L 162 x P 41 x H 114 cm

*Etagere in solid cherry with 3 shelves and precious workmanship on the legs. Total dimensions (W) 162, (D) 41, (H) 114 cm*

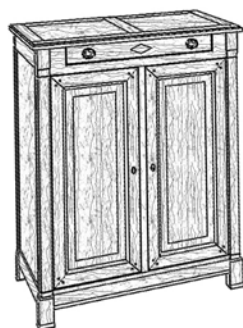

## CVA017

Portasedie in ciliegio predisposto per l'inserimento di ripiani, qualora non si volessero più utilizzare le sedie.  
Dimensioni totali L 115 x P 54 x H 141 cm

*Chair holder. It is possible to insert shelves, when one no longer wishes to use it for chairs. Total dimensions (W) 115, (D) 54, (H) 141cm*



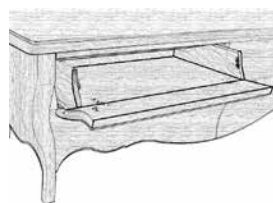
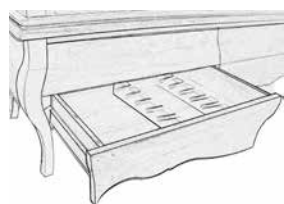
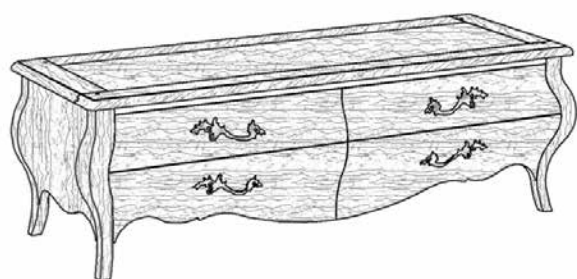

## CVA016

Porta TV in ciliegio con due cassetti inferiori con porta cd/dvd e due cassetti superiori con sportello a ribalta per accessori tv. Dimensioni totali L 159 x P 55 x H 52 cm

*TV Table in cherry wood with two drawers in the lower part for CDs and DVDs and two top drawers with downward opening door for tv accessories. Total dimensions (W) 159, (D) 55, (H) 52cm*

## CVA016L

Porta TV in tiglio con due cassetti inferiori con porta cd/dvd e due cassetti superiori con sportello a ribalta per accessori tv. Dimensioni totali L 159 x P 55 x H 52 cm

*TV Table in lime wood with two drawers in the lower part for CDs and DVDs and two top drawers with downward opening door for tv accessories. Total dimensions (W) 159, (D) 55, (H) 52cm*







## CVF006

Tavolo rettangolare in ciliegio/rovere con piano parchettato allungabile con 2 allunghe da cm.40,5 all'interno parchettate in rovere con inserti in ciliegio (aperto 247 x 89 x 78). Dimensioni totali L 166 x P 89 x H 78 cm

*Rectangular draw-leaf table in cherry/light oak with parquetted top and 2 internal pannels for lengthening 40,5 cm inside parquetted in light oak with cherry wood inserts (when open 247 x 89 x 78cm.). Total dimensions (W) 166, (D) 89, (H) 78 cm*

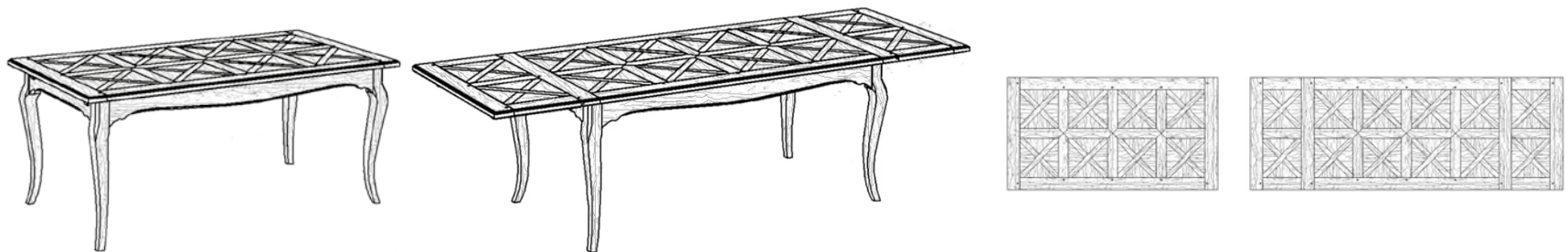

## CVF023

Tavolo quadrato in ciliegio/rovere con piano parchettato allungabile con 2 allunghe da cm 40,5 esterne parchettate in rovere con inserti in ciliegio (aperto 207 x 126 x 78). Dimensioni totali L 126 x P 126 x H 78 cm

*Square draw-leaf table in cherry/light oak with parquetted top and 2 parquetted leaves of 40,5 cm external parquetted in light oak with cherry wood inserts (when open 207 x 126 x 78 cm.). Total dimensions (W) 126, (D) 126, (H) 78 cm*



## CVF021

Tavolo ovale in ciliegio/rovere con piano allungabile parchettato in rovere ed intarsi in ciliegio con una allunga interna cinturata da 76 cm ed una esterna da 38 cm cinturata (aperto 237,5 x 161,5 x 78 cm). Dimensioni totali L 161,5 x P 123,5 x H 78 cm

*Oval draw-leaf table in cherry/light oak with pannel for lengthening in parquet of light oak with inlays in cherry with an internal belted leaf of 76 cm and an external belted leaf of 38 cm (when open 237,5 x 161,5 x 78 cm). Total dimensions (W) 161.5, (D) 123.5, (H) 78 cm*







## CVF046

Tavolo rettangolare in ciliegio/rovere con piano parchettato allungabile con due allunghe da cm 40,5 all'interno parchettate in rovere con inserti in ciliegio (aperto 321 x 126 x 78 cm).  
Dimensioni totali L 240 x P 126 x H 78 cm

*Rectangular table in cherry/oak with an extendible parquet top with two internal extensions measuring 40.5 cm in oak parquet with inserts in cherry wood (open 321 x 126 x 78 cm).  
Total dimensions (W) 240 x (D) 126 x H 78cm*

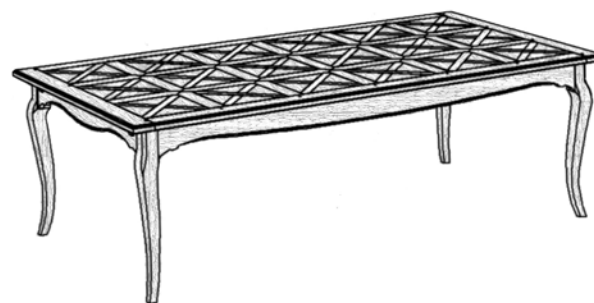

## CVF045

Tavolo rettangolare in ciliegio/rovere con piano parchettato allungabile con due allunghe da cm 44,5 all'interno parchettate in rovere con inserti in ciliegio (aperto 269 x 96 x 78 cm).  
Dimensioni totali L 180 x P 96 x H 78 cm

*Rectangular table in cherry/oak with an extendible parquet top with two internal extensions measuring 44.5 cm in oak parquet with inserts in cherry wood (open 269 x 96 x 78cm).  
Total dimensions (W) 180 x (D) 96 x H 78cm*

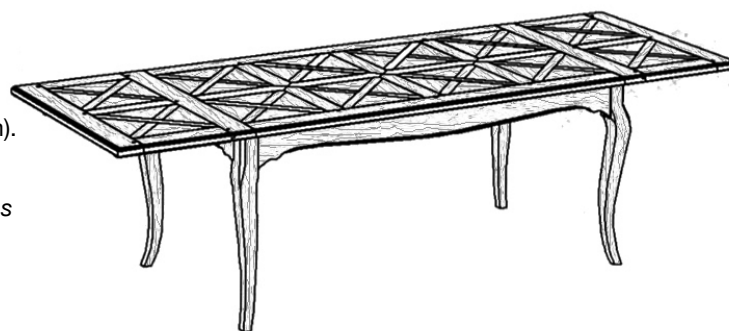





## CVF073

Tavolo rettangolare in ciliegio con piano impiallacciato come foto. Allungabile con due allunghe interne da 55 cm senza spondine. (aperto 350 x 110 x 78 cm)  
Dimensioni totali L 240 x P 110 x H 78 cm

*Rectangular table in cherry wood with inlaid top as photo. With 2 internal pannels cm 55 no belted (open 350 x 110 x 78 cm)  
Total dimensions (W) 240 x (D) 110 x H 78cm*

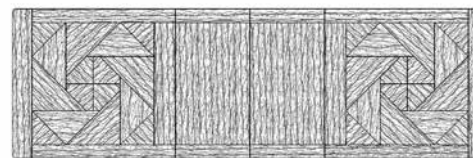
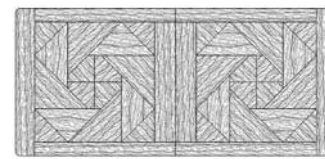

## CVF075

Tavolo rettangolare in ciliegio con piano impiallacciato come foto. Allungabile con due allunghe interne da 55 cm senza spondine. (aperto 270 x 110 x 78 cm)  
Dimensioni totali L 160 x P 110 x H 78 cm

*Rectangular table in cherry wood with inlaid top as photo. With 2 internal pannels cm 55 no belted (open 270 x 110 x 78 cm)  
Total dimensions (W) 160 x (D) 110 x H 78cm*

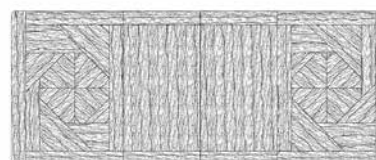
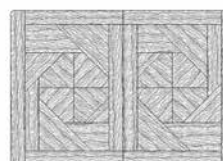

## CVF076

Tavolo quadrato in ciliegio con piano impiallacciato come foto. Allungabile con due allunghe interne da 55 cm senza spondine. (aperto 250 x 140 x 78 cm)  
Dimensioni totali L 140 x P 140 x H 78 cm

*Square table in cherry wood with inlaid top as photo. With 2 internal pannels cm 55 no belted (open 250 x 140 x 78cm)  
Total dimensions (W) 140 x (D) 140 x H 78cm*

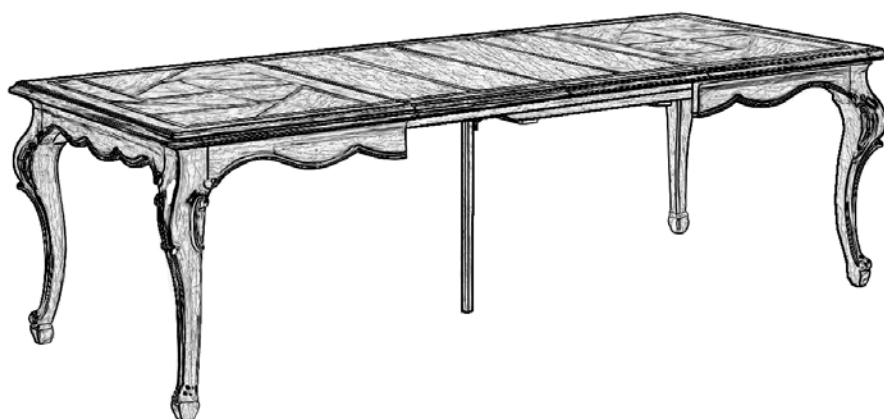
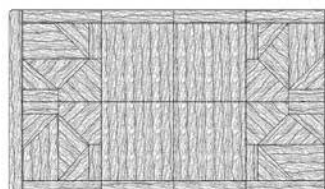





# CVF074

Tavolo rettangolare in ciliegio con piano impiallacciato come foto.  
Dimensioni totali L 235 x P 110 x H 78 cm

*Rectangular table in cherry wood with inlaid top as photo.  
Total dimensions (W) 235 x (D) 110 x H 78cm*

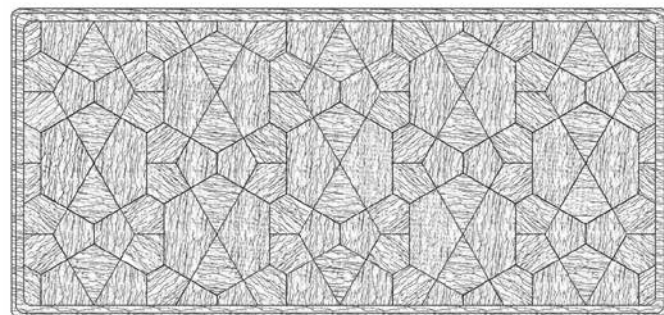
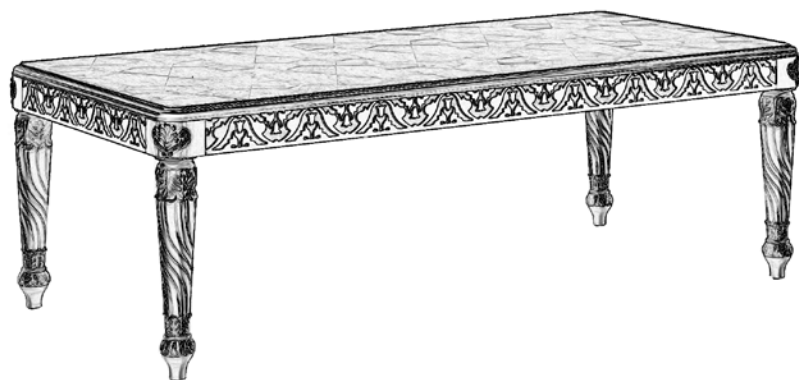





## CVF002Q

Tavolo quadrato scantonato in ciliegio/rovere con piano intarsiato allungabile con 1 allunga interna cinturata da cm 90 (aperto cm 200 x 110 x 80). Dimensioni totali L 110 x P 110 x H 80 cm

*Square draw-leaf table with rounded corners in cherry/light oak with inlaid top and 1 internal 90 cm belted panel for lengthening (when open cm 200 x 110 x 80). Total dimensions (W) 110, (D) 110, (H) 80 cm*

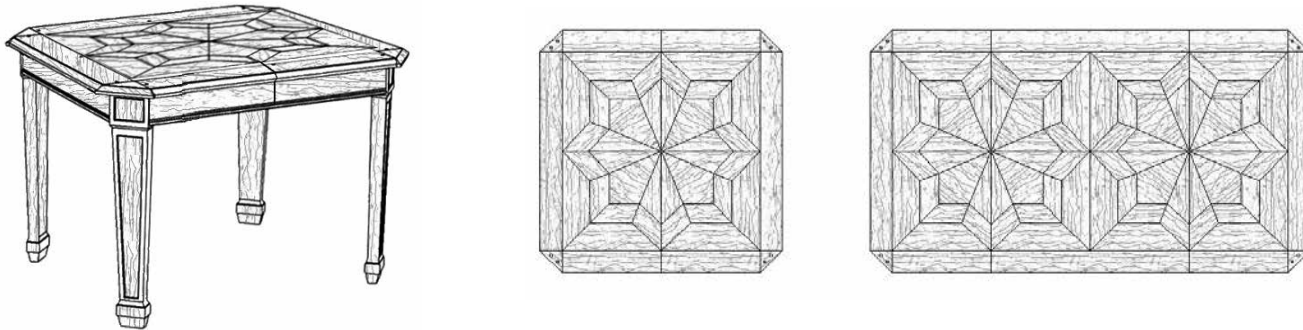

## CVF002R

Tavolo rettangolare scantonato in ciliegio/rovere con piano intarsiato allungabile con 2 allunghe interne da cm 46. Dimensioni totali L 201 x P 102,5 (aperto cm 293 x 102,5)

*Rectangular draw-leaf table with rounded corners in cherry/light oak with inlaid top and 2 internal panels for lengthening cm 46 each. Total dimensions (W) 201, (D) 102,5cm (when open 293 x 102,5cm)*

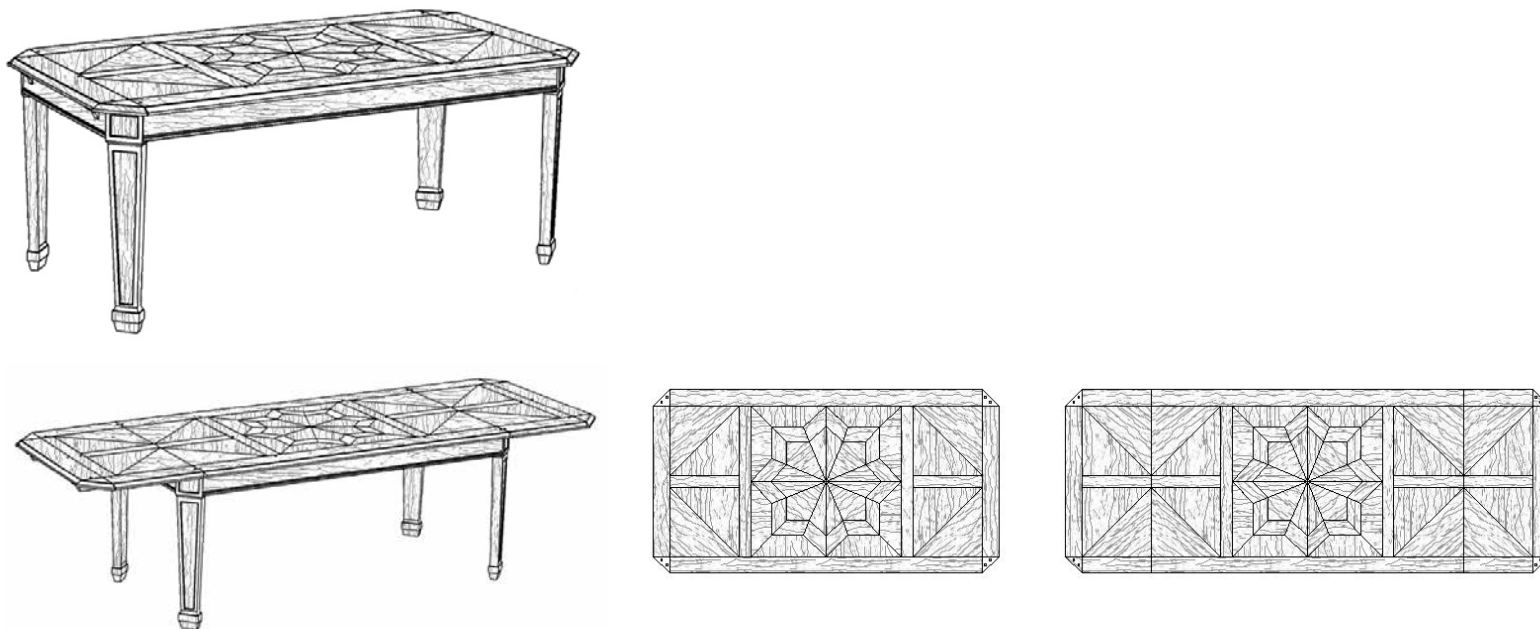















## CVF001

Tavolo rotondo in ciliegio/rovere con piano allungabile parchettato in rovere e ciliegio, con una allunga interna cinturata (aperto 205 x 130 x 80 cm). Dimensioni totali L 130 x P 130 x H 80 cm

*Round draw-leaf table in cherry/light oak with pannel for lengthening parquetted in light oak and cherry, with an internal belted extension (when open 205 x 130 x 80 cm).  
Total dimensions (W) 130, (D) 130, (H) 80 cm*

## CVF040

Tavolo rotondo in ciliegio/rovere con piano allungabile parchettato in rovere e ciliegio, con una allunga interna cinturata (aperto 195 x 120 x 80 cm). Dimensioni totali L 120 x P 120 x H 80 cm

*Round draw-leaf table in cherry/light oak with pannel for lengthening parquetted in light oak and cherry, with an internal belted extension (when open 195 x 120 x 80 cm).  
Total dimensions (W) 120, (D) 120, (H) 80 cm*

## CVF041

Tavolo rotondo in ciliegio/rovere con piano allungabile parchettato in rovere e ciliegio, con una allunga interna cinturata (aperto 215 x 140 x 80 cm). Dimensioni totali L 140 x P 140 x H 80 cm

*Round draw-leaf table in cherry/light oak with pannel for lengthening parquetted in light oak and cherry, with an internal belted extension (when open 215 x 140 x 80 cm).  
Total dimensions (W) 140, (D) 140, (H) 80 cm*









## CVF003S

Tavolo ovale in ciliegio con gamba a sciabola allungabile con 2 allunghe interne (di cui una cinturata e una no) da 43 cm (aperto 216 x 110 x 78). Piano con impiallacciatura a spina di pesce. Dimensioni totali L 130 x P 110 x H 78 cm

*Oval, draw-leaf table in cherry with sabre shaped legs and 2 internal pannels (one belted) for lengthening 43 cm each (when open 216 x 110 x 78). Top in fish bone veneer. Total dimensions (W) 130, (D) 110, (H) 78 cm*



## CVF003SI

Tavolo ovale in ciliegio con gamba a sciabola allungabile con 2 allunghe interne (di cui una cinturata e una no) da 43 cm (aperto 216 x 110 x 78). Piano con intarsio come da disegno. Dimensioni totali L 130 x P 110 x H 78 cm

*Oval, draw-leaf table in cherry with sabre shaped legs and 2 internal pannels (one belted) for lengthening 43 cm each (when open 216 x 110 x 78). Top with inlay as shown in design. Total dimensions (W) 130, (D) 110, (H) 78 cm*

## CVF003D

Tavolo ovale in ciliegio con gamba a spillo allungabile con 2 allunghe interne (di cui una cinturata e una no) da 43 cm (aperto 216 x 110 x 78). Piano con impiallacciatura a spina di pesce. Dimensioni totali L 130 x P 110 x H 78 cm

*Oval, draw-leaf table in cherry with stiletto legs and 2 internal panels (one belted) for lengthening 43 cm each (when open 216 x 110 x 78). Top in fish bone veneer. Total dimensions (W) 130, (D) 110, (H) 78 cm*



## CVF003DI

Tavolo ovale in ciliegio con gamba a spillo allungabile con 2 allunghe interne (di cui una cinturata e una no) da 43 cm (aperto 216 x 110 x 78). Piano con intarsio come da disegno. Dimensioni totali L 130 x P 110 x H 78 cm

*Oval, draw-leaf table in cherry with stiletto legs and 2 internal panels (one belted) for lengthening 43 cm each (when open 216 x 110 x 78). Top with inlay as shown in design. Total dimensions (W) 130, (D) 110, (H) 78 cm*

Piano intarsiato come a disegno  
Top with inlay as shown in the picture

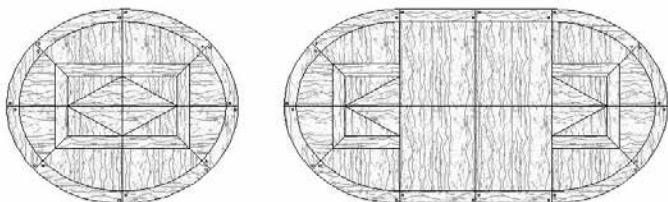

Piano a spina di pesce  
Top in fish bone veneer

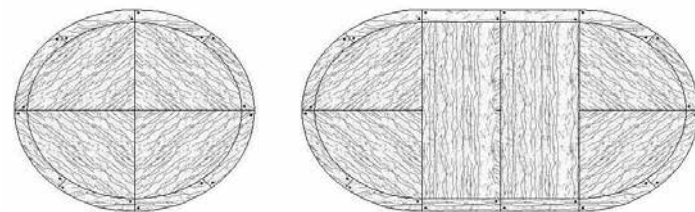





## CVF017

Tavolo in ciliegio rotondo fisso con piano intarsiato come da disegno.  
Dimensioni totali L 180 x P 180 x H 78 cm

Round table in cherry with inlaid top as shown.  
Total dimensions (W) 180, (D) 180, (H) 78 cm



## CVF022

Tavolo in ciliegio rotondo allungabile con 1 allunga interna da 50 cm.  
Dimensioni totali L 140 x P 140 x H 78 cm

Round draw-leaf table in cherry with 1 internal panel of 50 cm.  
Total dimensions (W) 140, (D) 140, (H) 78 cm

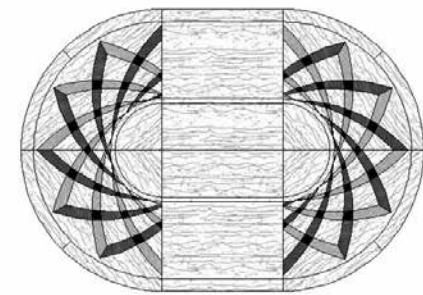
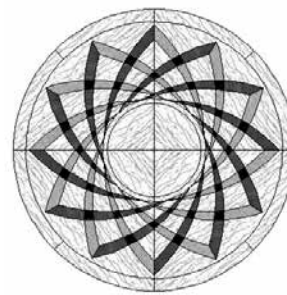





# CVF080

Tavolo in ciliegio rotondo allungabile con 1 allunga interna da 50 cm  
Dimensioni totali L 160 x H 78 cm

*Round table in cherrywood with 1 internal panel of 50 cm.  
Total dimensions (W) 160 x H 78cm*

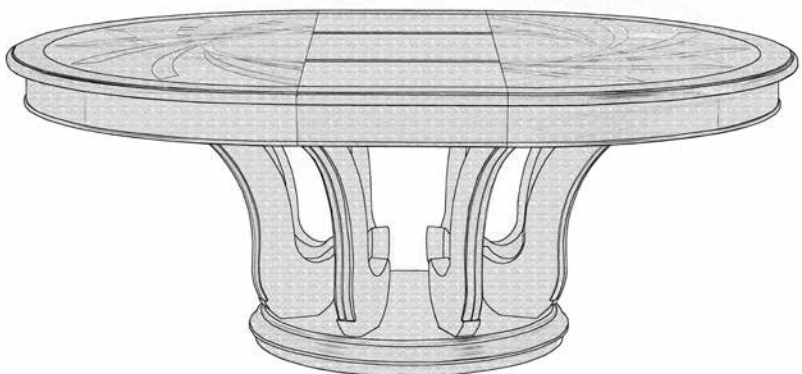
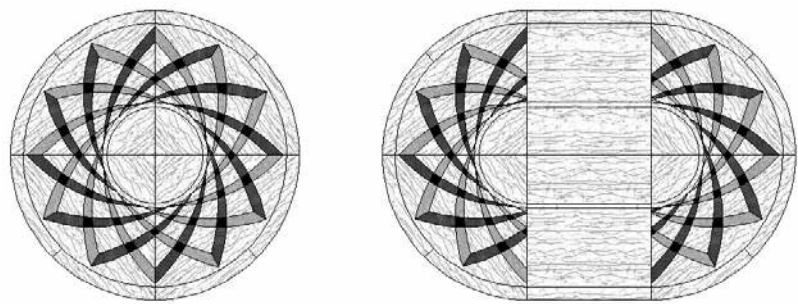





## TCA013

Tavolo in ciliegio ovale allungabile con 2 allunghe interne (di cui una cinturata e una no) aperto 210 x 100 x 78 cm. Piano con impiallacciatura a spina di pesce. Gambe a spillo.  
Dimensioni totali L 120 x P 100 x H 78 cm

*Oval draw-leaf table in cherry wood with 2 internal panels (one belted), when open 210 x 100 x 78cm. Fish-bone veneer top. Pin legs.  
Total dimensions (W) 120, (D) 100, (H) 78 cm*

## TCA010

Tavolo in ciliegio ovale allungabile con 2 allunghe interne (di cui una cinturata e una no) aperto 220 x 110 x 78 cm. Piano con impiallacciatura a spina di pesce. Gambe a spillo.  
Dimensioni totali L 130 x P 110 x H 78 cm

*Oval draw-leaf table in cherry wood with 2 internal panels (one belted), when open 220 x 110 x 78cm. Fish-bone veneer top. Pin legs.  
Total dimensions (W) 130, (D) 110, (H) 78 cm*

## TCA014

Tavolo in ciliegio ovale allungabile con 2 allunghe interne (di cui una cinturata e una no) aperto 230 x 100 x 78 cm. Piano con impiallacciatura a spina di pesce. Gambe a spillo.  
Dimensioni totali L 140 x P 100 x H 78 cm

*Oval draw-leaf table in cherry wood with 2 internal panels (one belted), when open 230 x 100 x 78cm. Fish-bone veneer top. Pin legs.  
Total dimensions (W) 140, (D) 100, (H) 78 cm*

## TCA015

Tavolo in ciliegio ovale allungabile con 3 allunghe interne (di cui 2 cinturate e una no) aperto 300 x 116 x 78 cm. Piano con impiallacciatura a spina di pesce. Gambe a spillo.  
Dimensioni totali L 160 x P 116 x H 78 cm

*Oval draw-leaf table in cherry wood with 3 internal panels (two belted), when open 300 x 116 x 78cm. Fish-bone veneer top. Pin legs.  
Total dimensions (W) 160, (D) 116, (H) 78 cm*

## TCA015I

Tavolo in ciliegio ovale intarsiato allungabile con 3 allunghe interne (di cui 2 cinturate e una no) aperto 300 x 116 x 78 cm. Piano con impiallacciatura a spina di pesce. Gambe a spillo.  
Dimensioni totali L 160 x P 116 x H 78 cm

*Oval draw-leaf table in cherry wood, inlaid, with 3 internal panels (two belted), when open 300 x 116 x 78cm. Fish-bone veneer top. Pin legs.  
Total dimensions (W) 160, (D) 116, (H) 78 cm*

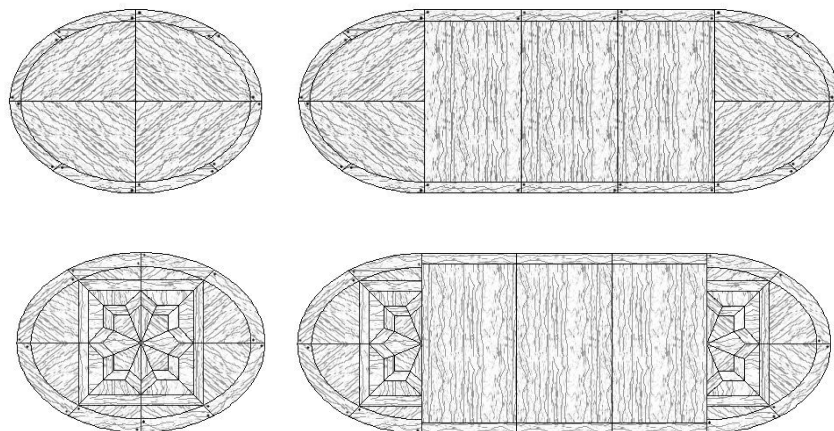

versione con intarsio disponibile solo per la misura da 160 cm  
inlaid version available just for the 160 cm dimension.





## TCA028

Tavolo ovale allungabile con tre allunghe esterne da 50 cm (due cinturate e una no). Gambe a spillo.  
Dimensioni totali L 110 x P 80 x H 78 cm

*Extendible oval table with three external extensions measuring 50 cm (two sprung and one not). Pin legs.  
Total dimensions (W) 110 x (D) 80 x (H) 78cm*



## TCA030

Tavolo ovale allungabile con tre allunghe esterne da 50 cm (due cinturate e una no). Gambe chippendale.  
Dimensioni totali L 110 x P 80 x H 78 cm

*Extendible oval table with three external extensions measuring 50 cm (two sprung and one not). Chippendale legs.  
Total dimensions (W) 110 x (D) 80 x (H) 78cm*









## NCF027

Tavolo rotondo in ciliegio con 3 allunghe da 60 cm con cintura di servizio. Gamba chippendale. Dimensioni totali L 140 x H 78 cm

*Round table in cherry wood with three extensions measuring 60 cm with springs. Chippendale leg. Total dimensions (W) 140 x (H) 78cm*





## CVF069

Tavolo in ciliegio rotondo fisso con gambone centrale intagliato a mano secondo le antiche tradizioni dell'ebanisteria veneta (a richiesta piano su misura). Dimensioni totali L 160 x H 78 cm

*Round table in cherry wood with central leg carved by hand in keeping with the ancient traditions of Venetian cabinet makers (table top made to measure on request). Total dimensions (W) 160 x (H) 78cm*









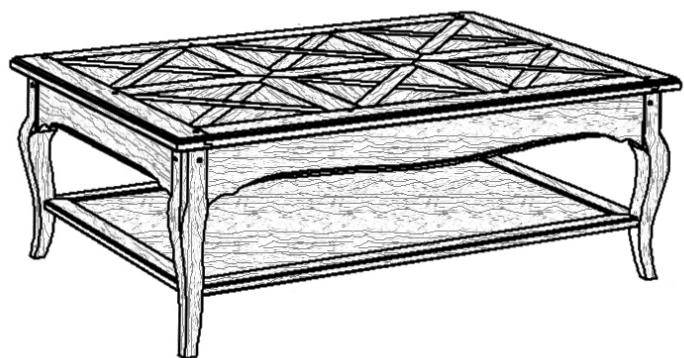

## CVF018

Tavolino rettangolare in rovere con piano parchettato in ciliegio.  
Dimensioni totali L 122 x P 84 x H 45 cm

*Small rectangular table in light oak with parquetted top in cherry. Total dimensions (W) 122, (D) 84, (H) 45 cm*



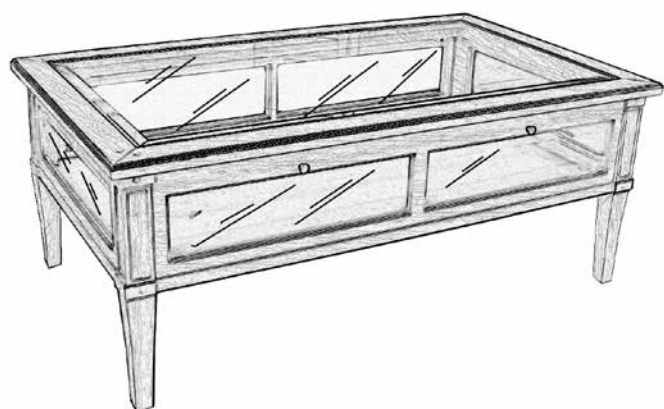

## TCV003

Tavolino in ciliegio con 2 sportelli apribili a ribalta sui lati lunghi, piano in vetro molato superiore e piano in legno inferiore. I vetri sul perimetro sono tutti molati. Dimensioni totali L 120 x P 70 x H 47 cm

*Small table in cherry wood with 2 horizontally opening doors on the long sides, bevelled glass top surface and lower shelf in wood. All glass round the edges is bevelled. Total dimensions (W) 120, (D) 70, (H) 47 cm*



## NCF019

Tavolino rettangolare in ciliegio con piano intarsiato  
Dimensioni totali L 120 x P 80 x H 50,5 cm

*Rectangular coffee table in cherry wood with inlaid table top  
Total dimensions (W) 120 x (D) 80 x H 50,5cm*





## CVF039

Tavolino in ciliegio con 2 cassetti. Parte inferiore sagomata.  
Dimensioni totali L 130 x P 80 x H 39 cm

*Coffee table in cherry wood with two drawers. Contoured lower part.  
Total dimensions (W) 130 x (D) 80 x (H) 39cm*

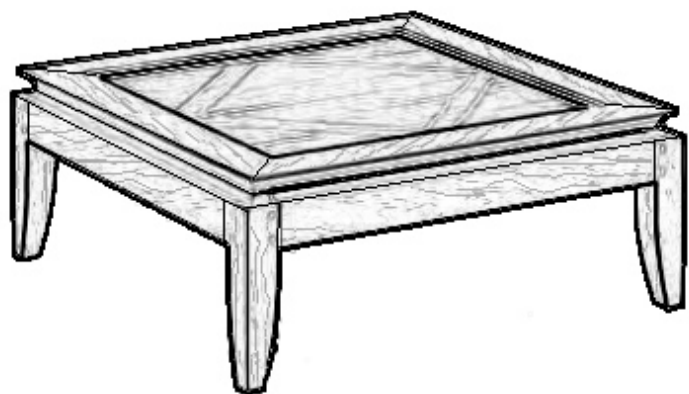

## CVF065

Tavolino quadrato in ciliegio con 2 cassetti. Piano intarsiato.  
Dimensioni totali L 100 x 100 x H 41 cm

*Square coffee table in cherry wood with two drawers. Inlaid table top.  
Total dimensions (W) 100 x (D) 100 x (H) 41cm*





## CVF066

Tavolino rettangolare in ciliegio con 2 cassetti. Piano intarsiato.  
Dimensioni totali L 120 x 80 x H 41 cm

*Rectangular coffee table in cherry wood with two drawers. Inlaid table top.  
Total dimensions (W) 120 x (D) 80 x (H) 41cm*



## NCF026

Tavolino quadrato in ciliegio con piano intarsiato.  
Dimensioni totali L 120 x 120 x H 41 cm

*Square coffee table in cherry wood with inlaid table top.  
Total dimensions (W) 120 x (D) 120 x (H) 41cm*



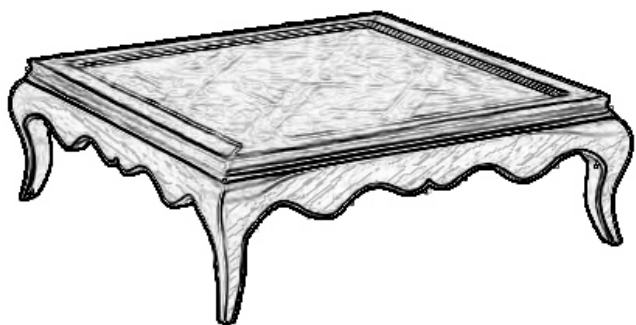

## CVF063

Tavolino quadrato in ciliegio con piano intarsiato.  
Dimensioni totali L 120 x 120 x H 41 cm

*Square coffee table in cherry wood with inlaid table top.  
Total dimensions (W) 120 x (D) 120 x (H) 41cm*

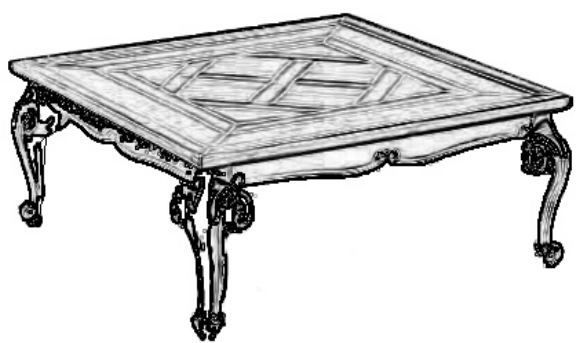

## NCF025

Tavolino quadrato in ciliegio con piano intarsiato.  
Dimensioni totali L 121 x 121 x H 41 cm

*Square coffee table in cherry wood with inlaid table top.  
Total dimensions (W) 121 x (D) 121 x (H) 41cm*



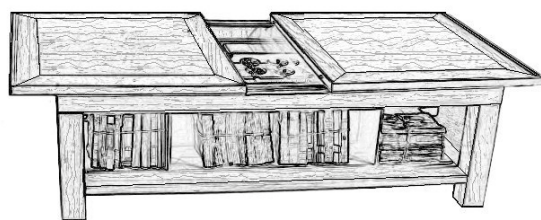
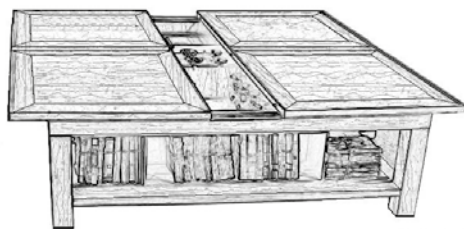

## NCF030

Tavolino in ciliegio rettangolare con interni in rovere, apribile, con porta bottiglie e bicchieri. Top con riquadratura. Dimensioni totali L 120 x P 80 x H 45,5 cm

*Small rectangular table in cherry wood, inside in light oak, can be opened, with bottle and glass holders. Squared top. Total dimensions (W) 120, (D) 80, (H) 45.5 cm*

## NCF031

Tavolino in ciliegio quadrato con interni in rovere, apribile, con porta bottiglie e bicchieri. Top con riquadratura. Dimensioni totali L 120 x P 120 x H 45,5 cm

*Small square table in cherry wood, inside in light oak, can be opened, with bottle and glass holders. Squared top. Total dimensions (W) 120, (D) 120, (H) 45.5 cm*

## CVF032

Tavolino sagomato nella parte inferiore con piano in legno e con 1 cassetto.  
Dimensioni totali L 127 x P 127 x H 45 cm

*Coffee table contoured at the bottom with a wooden top and one drawer.  
Total dimensions (W) 127 x (D) 127 x (H) 45 cm*

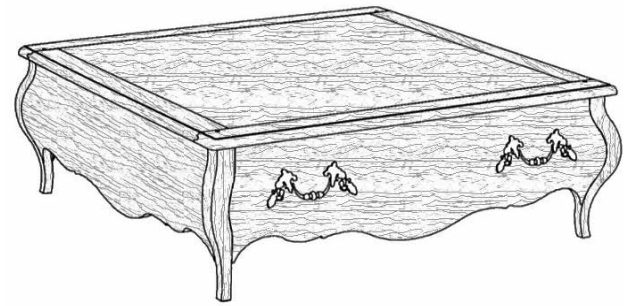

## CVF062

Tavolino sagomato nella parte inferiore con piano intarsiato come disegno  
e con 1 cassetto. Dimensioni totali L 127 x P 127 x H 45 cm

*Coffee table contoured at the bottom with inlaid top as drawing and one  
drawer. Total dimensions (W) 127 x (D) 127 x (H) 45 cm*

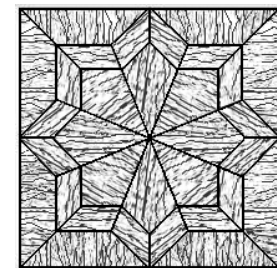
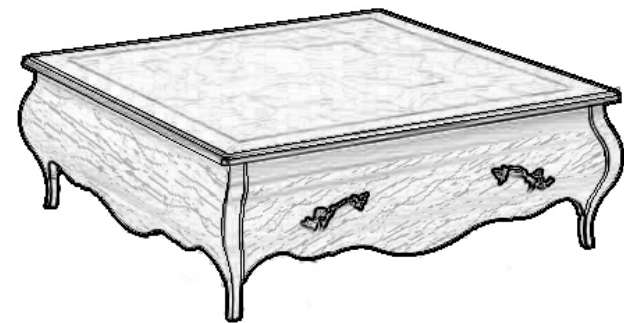





## CVF010

Tavolino rettangolare in ciliegio con piano in vetro e perline decorative in ottone. Il vetro del piano superiore è molato. Dimensioni totali L 110 x P 55 x H 45 cm

*Rectangular coffee table in cherry wood with glass top and decorative beaded brass. The glass on the upper surface is opaque. Total dimensions (W) 110 x (D) 55 x (H) 45cm*

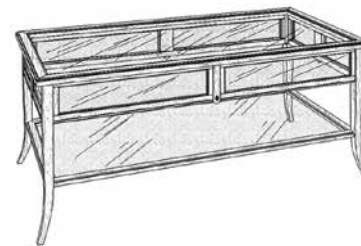

## CVF019

Tavolino rettangolare in ciliegio con piano in vetro e perline decorative in ottone. Il vetro del piano superiore è molato. Dimensioni totali L 120 x P 80 x H 45 cm

*Rectangular coffee table in cherry wood with glass top and decorative beaded brass. The glass on the upper surface is opaque. Total dimensions (W) 120 x (D) 80 x (H) 45cm*

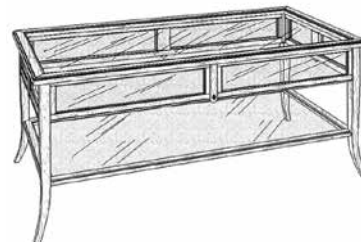

## CVF009

Tavolino quadrato in ciliegio con piano in vetro e perline decorative in ottone. Il vetro del piano superiore è molato. Dimensioni totali L 100 x P 100 x H 45 cm

*Square coffee table in cherry wood with glass top and decorative beaded brass. The glass on the upper surface is opaque. Total dimensions (W) 100 x (D) 100 x (H) 45cm*

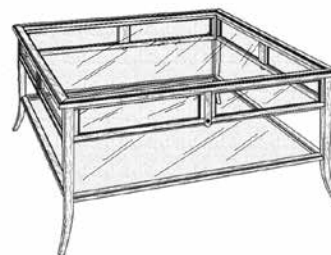

## CVF024

Tavolino quadrato in ciliegio con piano in vetro e perline decorative in ottone. Il vetro del piano superiore è molato. Dimensioni totali L 70 x P 70 x H 60 cm

*Square coffee table in cherry wood with glass top and decorative beaded brass. The glass on the upper surface is opaque. Total dimensions (W) 70 x (D) 70 x (H) 60 cm*



## CVF025

Tavolino quadrato in ciliegio con piano in vetro e perline decorative in ottone. Il vetro del piano superiore è molato. Dimensioni totali L 70 x P 70 x H 45 cm

*Square coffee table in cherry wood with glass top and decorative beaded brass. The glass on the upper surface is opaque. Total dimensions (W) 70 x (D) 70 x (H) 45cm*









## CVF014

Tavolino in ciliegio/rovere con 1 cassetto frontale, 1 tiretto laterale ed un tiretto segreto con premi-apri. Preziosi fregi in ottone sulle 4 gambe. Dimensioni totali L 47 x P 38 x H 78 cm

*Small table in cherry/light oak with 1 drawer at the front, 1 small disappearing shelf-pannel on the side and 1 secret small disappearing pannel with click-button to open. Precious embellishments in brass on the 4 legs. Total dimensions (W) 47, (D) 38, (H) 78 cm*



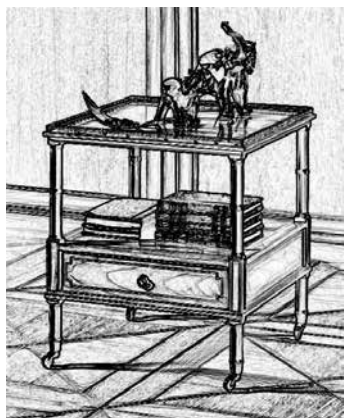

## CVF026

Tavolino in ciliegio quadrato con 1 cassetto intarsiato passante. Con ruote ottonate e con perline decorative sul piano.  
Dimensioni totali L 55 x P 55 x H 62 cm

*Square coffee table in cherry wood with one dyed inlaid drawer. With brass finished wheels and with decorative beading on the top.  
Total dimensions (W) 55 x (D) 55 x (H) 62 cm*



## CVF038

Mobiletto in ciliegio con 1 cassetto e con piano in pelle. (Pelle occorrente 0,3 mq) Dimensioni totali L 52 x P 72 x H 60 cm

*Cupboard in cherry wood with one drawer and leather top. (leather required 0.3 SQ) Total dimensions (W) 52 x (D) 72 x (H) 60 cm*





## CVF037

Tavolino ovale con piano intarsiato ciliegio. Con 1 cassetto. Con gambe a spillo. Dimensioni totali L 70 x 48 x H 68 cm

*Oval coffee table with inlaid cherry wood. With one drawer. With pin legs. Total dimensions (W) 70 x (D) 48 x (H) 68 cm*





## NCF014

Tavolino rotondo in ciliegio.  
Dimensioni totali L 69 x H 75 cm

*Round coffee table in cherry wood.  
Total dimensions (W) 69, (H) 75cm*





## CVF035

Tavolino rotondo con piano intarsiato ciliegio. Con 1 cassetto.  
Con gambe a spillo. Dimensioni totali L 60 x x H 68 cm

*Round coffee table with inlaid cherry wood. With one drawer. Pin legs.  
Total dimensions (W) 60 x x (H) 68 cm*



## CVF012

Tavolino rotondo in ciliegio/rovere con cassetto.  
Top e ripiano inferiore con intarsio.  
Dimensioni totali L 63 x P 63 x H 75 cm

*Small round table in cherry/light oak with drawer. Upper and lower tops both inlaid. Total dimensions (W) 63, (D) 63, (H) 75 cm*





## CVF013

Tavolino rotondo in ciliegio con cassetto. Piano contornato da fascia perimetrale. Dimensioni totali L 52 x P 52 x H 70 cm

*Small round table in cherry wood with drawer. The top is edged with a band. Total dimensions (W) 52, (D) 52, (H) 70 cm*





studio  
**zona studio**







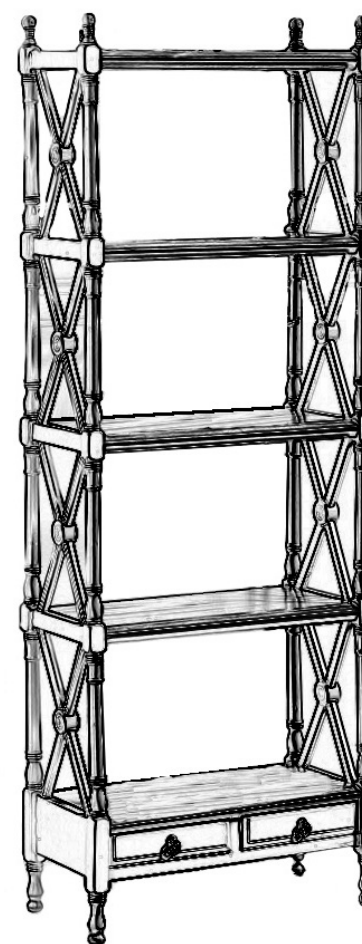

## NCZ005

Libreria con due cassetti inferiori.  
Dimensioni totali L 56 x P 26 x H 154 cm

*Bookcase with two bottom drawers.  
Total dimensions (W) 56 x (D) 26 x (H) 154cm*



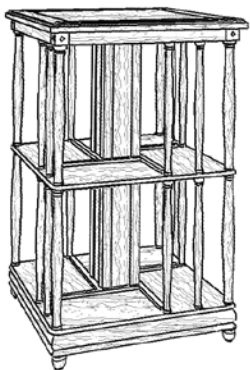
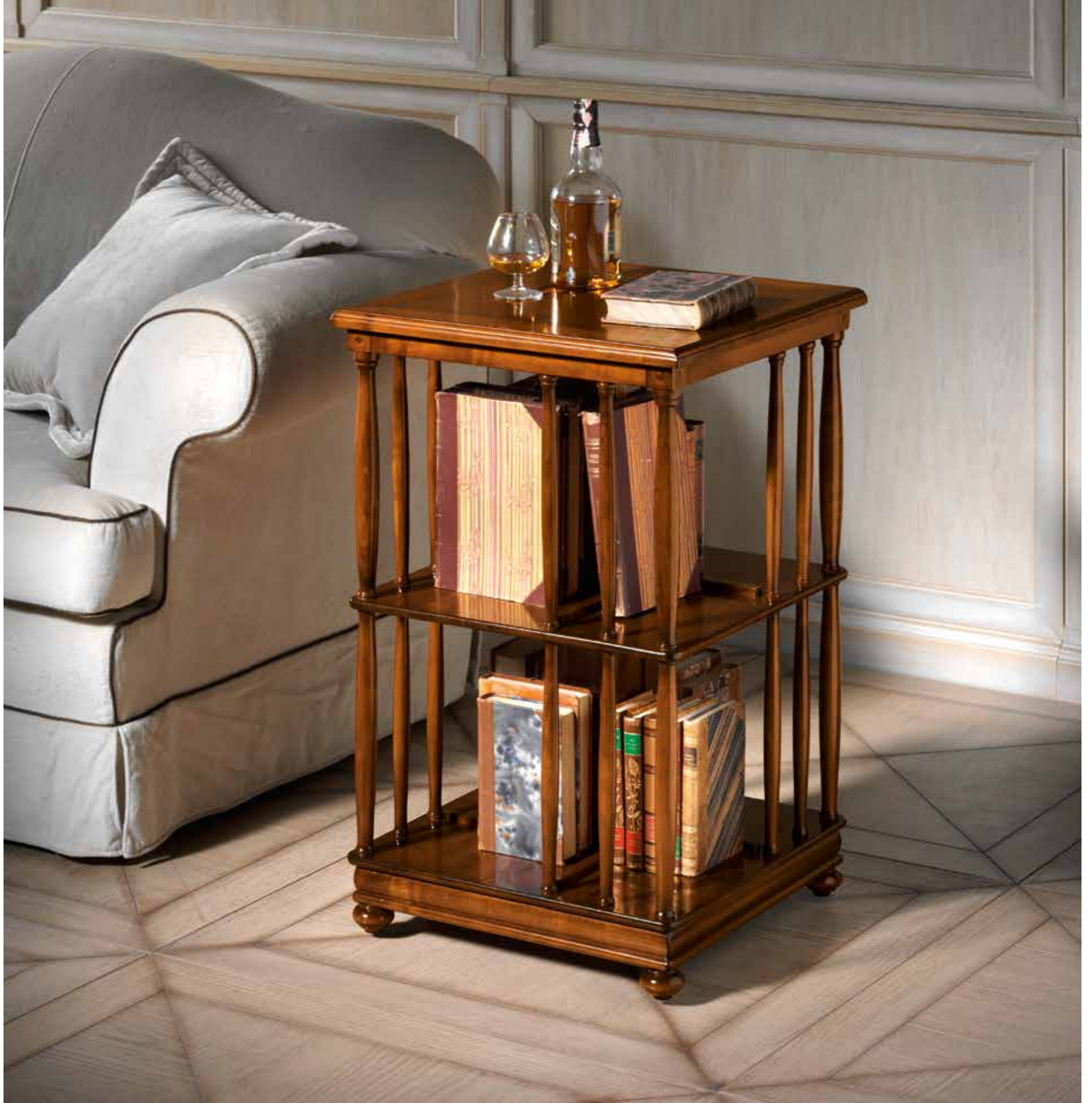

## CVA015

Libreria in ciliegio con ruote piroettanti.  
Dimensioni totali L 51 x P 51 x H 81 cm

*Bookcase in cherry wood with swivel wheels.  
Total dimensions (W) 51, (D) 51, (H) 81 cm*

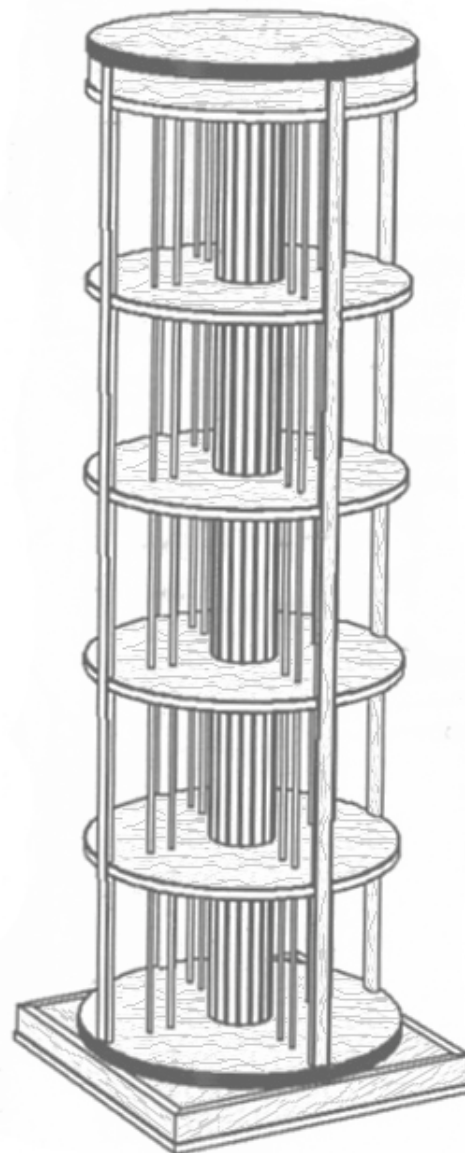

## CVA014

Libreria in ciliegio con base fissa e parte superiore girevole con divisori verticali in ottone. Dimensioni totali L 56 x P 56 x H 180 cm

*Bookcase in cherry wood with fixed base and swivel top with vertical brass dividing device. Total dimensions (W) 56, (D) 56, (H) 180 cm*



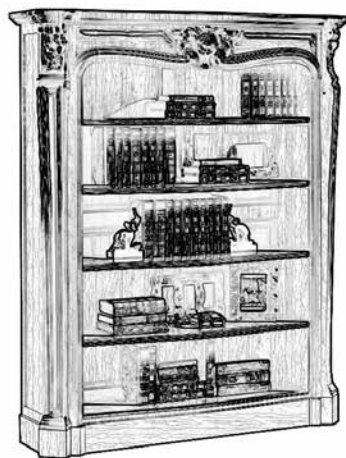

## CVA038

Libreria sagomata con montanti intagliati.  
Dimensioni totali L 149,5 x P 44 x H 186 cm

*Bookcase with two bottom drawers.*  
*Total dimensions (W) 149.5 x (D) 44 x (H) 186cm*

## CVA009

Libreria in ciliegio con schienale e 3 ripiani in frassino massiccio regolabili a scaletta e schienale intelaiato in massello di frassino. Dimensioni totali L 150 x P 35 x H 150 cm

*Bookcase in cherry with back-pannel and 3 shelves in solid ash which can be adjusted to a step. Framed back-pannel in ash blockwood. Total dimensions (W) 150, (D) 35, (H) 150 cm*

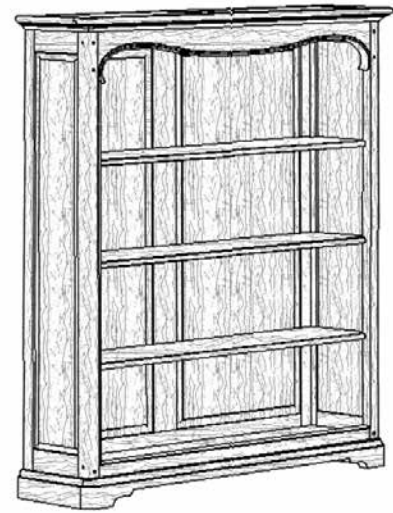

## CVA023

Libreria in ciliegio con schienale e 3 ripiani in frassino massiccio regolabili a scaletta e schienale intelaiato in massello di frassino. Dimensioni totali L 130 x P 35 x H 150 cm

*Bookcase in cherry with back-pannel and 3 shelves in solid ash which can be adjusted to a step. Framed back-pannel in ash blockwood. Total dimensions (W) 130, (D) 35, (H) 150 cm*

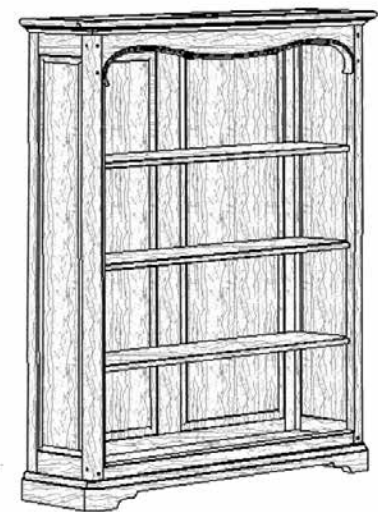













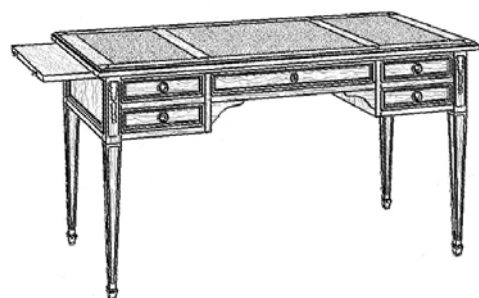

## CVB006P

Scrittoio in ciliegio con piano in pelle con decori in oro e 2 tiri estraibili, puntali e fregi in ottone (pelle occorrente 1,30 mq). Dimensioni totali L 120 x P 60 x H 79 cm

*Desk in cherry with top in leather with decorations in gold and 2 little disappearing tops, caps and embellishments in brass (takes 1,30 sq m of leather). Total dimensions (W) 120, (D) 60, (H) 79 cm*

## CVB007P

Scrittoio in ciliegio con piano in pelle con decori in oro e 2 tiri estraibili, puntali e fregi in ottone (pelle occorrente 1,40 mq). Dimensioni totali L 140 x P 70 x H 79 cm

*Desk in cherry with top in leather with decorations in gold and 2 little disappearing tops, caps and embellishments in brass (takes 1,40 sq m of leather). Total dimensions (W) 140, (D) 70, (H) 79 cm*

## CVB027P

Scrittoio in ciliegio con piano in pelle con decori in oro e 2 tiri estraibili, puntali e fregi in ottone (pelle occorrente 2,30 mq). Dimensioni totali L 160 x P 80 x H 79 cm

*Desk in cherry with top in leather with decorations in gold and 2 little disappearing tops, caps and embellishments in brass (takes 2,30 sq m of leather). Total dimensions (W) 160, (D) 80, (H) 79 cm*



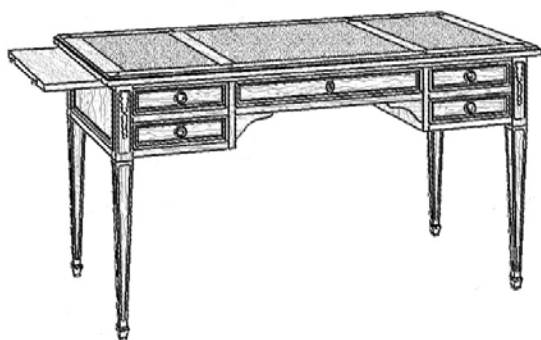

## CVB006

Scrivania in ciliegio con piano in legno riquadrato in 3 parti e 2 tiri estraibili, punte e fregi in ottone.  
Dimensioni totali  
L 120 x P 60 x H 79 cm

*Desk in cherry with top in squared wood in 3 parts and 2 little disappearing tops, caps and embellishments in brass. Total dimensions (W) 120, (D) 60, (H) 79 cm*

## CVB007

Scrivania in ciliegio con piano in legno riquadrato in 3 parti e 2 tiri estraibili, punte e fregi in ottone.  
Dimensioni totali  
L 140 x P 70 x H 79 cm

*Desk in cherry with top in squared wood in 3 parts and 2 little disappearing tops, caps and embellishments in brass. Total dimensions (W) 140, (D) 70, (H) 79 cm*

## CVB027

Scrivania in ciliegio con piano in legno riquadrato in 3 parti e 2 tiri estraibili, punte e fregi in ottone.  
Dimensioni totali  
L 160 x P 80 x H 79 cm

*Desk in cherry with top in squared wood in 3 parts and 2 little disappearing tops, caps and embellishments in brass. Total dimensions (W) 160, (D) 80, (H) 79 cm*

# CVB009

Scrivania in ciliegio con 9 cassetti con 2 tiretti laterali, piano centrale in pelle con decoro in oro,  
(struttura smontabile, pelle occorrente 0,8 mq).  
Dimensioni totali L 186 x P 93 x H 80 cm

*Desk in cherry wood with 9 drawers and 2 little disappearing tops on the sides, central top in leather  
with decorations in gold, (can be dismantled, takes 0.8 sq m of leather).  
Total dimensions (W) 186, (D) 93, (H) 80 cm*









## CVB023

Scrittoio in ciliegio con 9 cassetti e 2 tiri laterali,  
piano centrale in pelle con decori in oro.  
(STRUTTURA SMONTABILE, PELLE OCCORRENTE 0,8 MQ)  
Dimensioni totali L 151 x P 75 x H 80 cm

*Desk in cherry wood with nine drawers and two flat drawers,  
central top in leather with gold decorations.  
(REMOVABLE STRUCTURE, LEATHER REQUIRED 0.8 SQ)  
Total dimensions (W) 151 x (D) 75 x (H) 80cm*



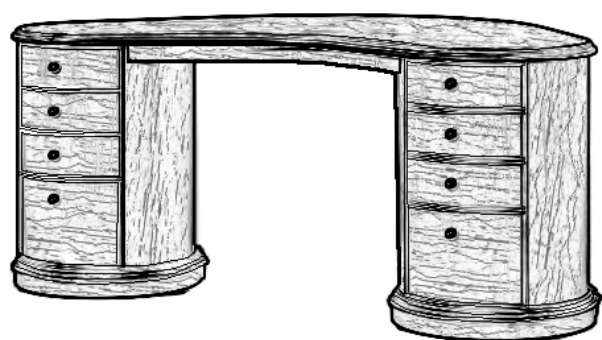

## CVB029

Scrivania sagomata in rovere con sei cassetti e due cestoni apribili, con un cassetto centrale portapenne.  
Dimensioni totali L 185 x P 109 x H 78 cm

*Shaped oak desk with 6 drawers and 2 deep drawers.  
With 1 central small drawer for pens.  
Total dimensions (W) 185 x (D) 109 x (H) 78cm*

## CVB030

Scrivania in ciliegio con lavorazioni in legno particolari e montanti lavorati come foto. Con tre cassettini superiori con incavo uso maniglia, cassetto centrale con attrezzatura interna portapenne. Con quattro cassetti e due cestoni apribili con maniglie in legno. Piano in legno.  
Dimensioni totali L 204,5 x P 98,5 x H 78 cm

*Desk in cherry wood with woodwork details and uprights worked as a photo. With three upper drawers with recessed handle, central drawer with interior accessories for pens. With four drawers and two deep drawers that open with wooden handles. Top in wood.  
Total dimensions (W) 204.5 x (D) 98.5 x (H) 78cm*

## CVB033

Scrivania in ciliegio con lavorazioni in legno particolari e montanti lavorati come foto. Con tre cassettini superiori con incavo uso maniglia, cassetto centrale con attrezzatura interna portapenne. Con quattro cassetti e due cestoni apribili con maniglie in legno. Piano in legno.  
Dimensioni totali L 180 x P 98,5 x H 78 cm

*Desk in cherry wood with woodwork details and uprights worked as a photo. With three upper drawers with recessed handle, central drawer with interior accessories for pens. With four drawers and two deep drawers that open with wooden handles. Top in wood.  
Total dimensions (W) 180 x (D) 98.5 x (H) 78cm*

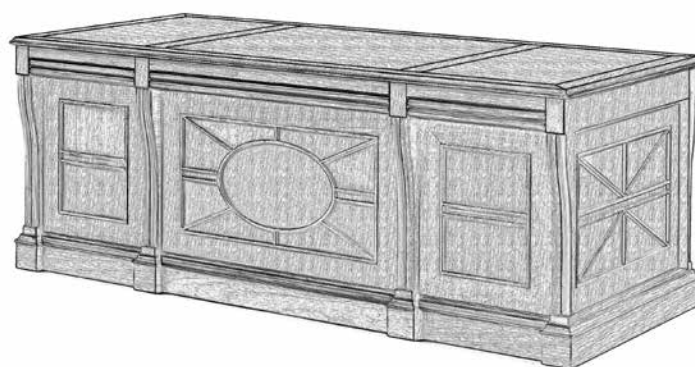
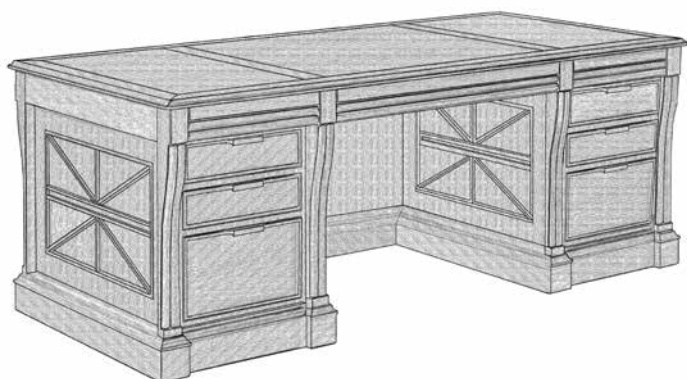







## CVB020

Bureau in noce con piano estraibile. Con 5 cassetti + 4 cassettoni su alzatina. Con decoro centrale.  
Dimensioni totali L 90 x P 45 x H 98 cm

*Walnut bureau with pull-out surface. With five drawers + four small drawers under sliding top. With central decoration.  
Total dimensions (W) 90 x (D) 45 x (H) 98cm*





## 0XB004

Bureau con 5 cassetti in noce; piano estraibile e serrandina. All'interno secretaire con 4 cassettini. Dimensioni totali L 116 x P 50,5 x H 107 cm

*Walnut writing desk with five drawers, pull-out surface and roll top.  
Contains a secretaire with four small drawers.  
Total dimensions (W) 116 x (D) 50,5 x (H) 107cm*

# CVF008

Tavolo riunioni in ciliegio piano con inserti in pelle, basamento ovale perlinato.  
Dimensioni totali L 280 x P 140 x H 78 cm

*Meeting table in cherry, top with leather inserts, oval based pedestal in narrow matchboarding.*  
*Total dimensions (W) 280, (D) 140, (H) 78 cm*

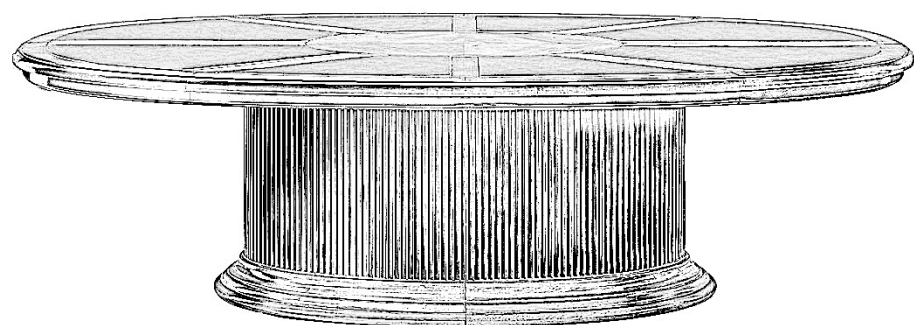







bedroom  
**zona notte**





## CVL012T

Letto in tiglio imbottito in tessuto capitonné, con prezioso intaglio su testata (rete esclusa da 180 x 200 cm).  
Dimensioni totali L 220 x P 212 x H 158 cm

*Bed in lime-tree wood with quilted fabric upholstery, with a beautifully carved headboard (excluding sprung base measuring 180 x 200cm)  
Total dimensions (W) 220 x (D) 212 x (H) 158cm*

## CVL012P

Letto in tiglio imbottito in pelle capitonné, con prezioso intaglio su testata (rete esclusa da 180 x 200 cm).  
Dimensioni totali L 220 x P 212 x H 158 cm

*Bed in lime-tree wood with quilted leather upholstery, with a beautifully carved headboard (excluding sprung base measuring 180 x 200cm)  
Total dimensions (W) 220 x (D) 212 x (H) 158cm*

## CVL012B

Letto in tiglio imbottito in tessuto/pelle cliente capitonné. Testata intagliata a mano (rete esclusa da 180x200 cm).  
Dimensioni totali L 220 x P 212 x H 158 cm

TESSUTO OCCORENTE PER L'IMBOTTITURA MT 7 IN H MT 1,40 TESSUTO - MQ 9 PELLE

*Bed with headboard in customer's fabric or leather upholstery. Hand-carved headboard (excluding sprung base 180x200cm).  
Total dimensions (W) 220 x (D) 212 x (H) 158cm*

REQUIRED FABRIC FOR THE UPHOLSTERING 7 IN H 1,40 M - LEATHER 9 SQ.







## CVL014T

Letto tutto imbottito in tessuto o ecopelle capitonnè. Testata intagliata a mano (rete esclusa da 165x200 cm).  
Dimensioni totali L 184 x P 210 x H 133 cm

*Bed with headboard in fabric or eco-leather capitonnè. Hand-carved headboard (excluding sprung base 165x200 cm).  
Total dimensions (W) 184 x (D) 210 x (H) 133 cm*

## CVL015T

Letto tutto imbottito in tessuto o ecopelle capitonnè. Testata intagliata a mano (rete esclusa da 180x200 cm).  
Dimensioni totali L 190 x P 210 x H 133 cm

*Bed with headboard in fabric or eco-leather upholstery. Hand-carved headboard (excluding sprung base 180x200cm).  
Total dimensions (W) 190 x (D) 210 x (H) 133cm*

## CVL014P

Letto tutto imbottito in pelle capitonnè. Testata intagliata a mano (rete esclusa da 165x200 cm).  
Dimensioni totali L 184 x P 210 x H 133 cm

*Bed with headboard in leather upholstery. Hand-carved headboard (excluding sprung base 165x200cm).  
Total dimensions (W) 184 x (D) 210 x (H) 133cm*

## CVL015P

Letto tutto imbottito in pelle capitonnè. Testata intagliata a mano (rete esclusa da 180x200 cm).  
Dimensioni totali L 190 x P 210 x H 133 cm

*Bed with headboard in leather upholstery. Hand-carved headboard (excluding sprung base 180x200cm).  
Total dimensions (W) 190 x (D) 210 x (H) 133cm*

## CVL014B

Letto tutto imbottito in tessuto/pelle cliente capitonnè. Testata intagliata a mano (rete esclusa da 165x200 cm).  
Dimensioni totali L 184 x P 210 x H 133 cm

TESSUTO OCCORENTE PER L'IMBOTTITURA MT 6,5 IN H MT 1,40 TESSUTO - MQ 12,5 PELLE

*Bed with headboard in customer's fabric or leather upholstery. Hand-carved headboard (excluding sprung base 165x200cm).  
Total dimensions (W) 184 x (D) 210 x (H) 133cm*

REQUIRED FABRIC FOR THE UPHOLSTERING 6,5 IN H 1,40 M - LEATHER 12,5 SQ.

## CVL015B

Letto tutto imbottito in tessuto/pelle cliente capitonnè. Testata intagliata a mano (rete esclusa da 180x200 cm).  
Dimensioni totali L 190 x P 210 x H 133 cm

TESSUTO OCCORENTE PER L'IMBOTTITURA MT 9 IN H MT 1,40 TESSUTO - MQ 16 PELLE

*Bed with headboard in customer's fabric or leather upholstery. Hand-carved headboard (excluding sprung base 180x200cm).  
Total dimensions (W) 190 x (D) 210 x (H) 133cm*

REQUIRED FABRIC FOR THE UPHOLSTERING 9 IN H 1,40 M - LEATHER 16 SQ.

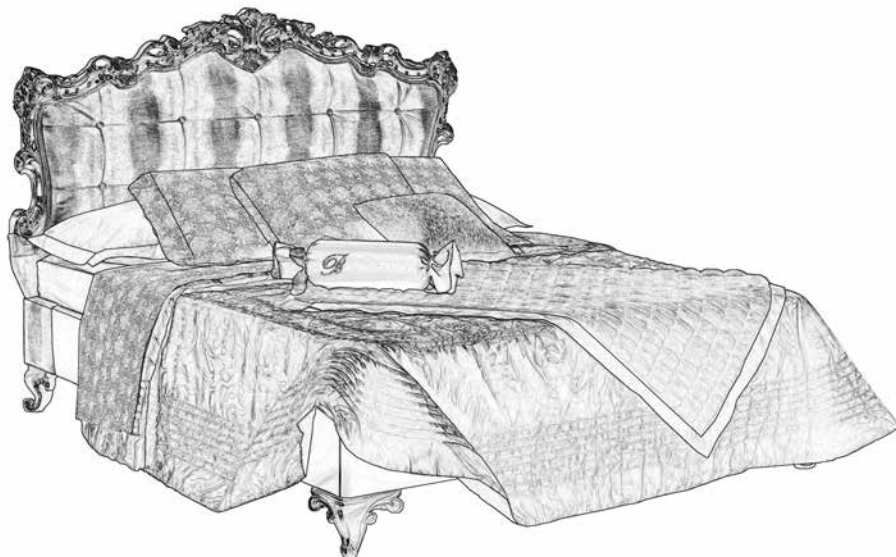





## CVL016T

Letto tutto imbottito in tessuto o ecopelle capitonnè. Testata e pediera intagliate a mano (rete esclusa da 170x200 cm).  
Dimensioni totali L 192 x P 213 x H 165 cm

*Bed in fabric or eco-leather upholstery. Hand-carved headboard and footboard (excluding sprung base 170x200cm).  
Total dimensions (W) 192 x (D) 213 x (H) 165cm*

## CVL017T

Letto tutto imbottito in tessuto o ecopelle capitonnè. Testata e pediera intagliate a mano (rete esclusa da 200x200 cm).  
Dimensioni totali L 222 x P 213 x H 168 cm

*Bed in fabric or eco-leather upholstery. Hand-carved headboard and footboard (excluding sprung base 200x200cm).  
Total dimensions (W) 222 x (D) 213 x (H) 168cm*

## CVL016P

Letto tutto imbottito in pelle capitonnè. Testata e pediera intagliate a mano (rete esclusa da 170x200 cm).  
Dimensioni totali L 192 x P 213 x H 165 cm

*Bed in leather upholstery. Hand-carved headboard and footboard (excluding sprung base 170x200cm).  
Total dimensions (W) 192 x (D) 213 x (H) 165cm*

## CVL017P

Letto tutto imbottito in pelle capitonnè. Testata e pediera intagliate a mano (rete esclusa da 200x200 cm).  
Dimensioni totali L 222 x P 213 x H 168 cm

*Bed in leather upholstery. Hand-carved headboard and footboard (excluding sprung base 200x200cm).  
Total dimensions (W) 222 x (D) 213 x (H) 168cm*

## CVL016B

Letto tutto imbottito in tessuto/pelle cliente capitonnè. Testata e pediera intagliate a mano (rete esclusa da 170x200 cm).  
Dimensioni totali L 192 x P 213 x H 165 cm

TESSUTO OCCORENTE PER L'IMBOTTITURA MT 7 IN H MT 1,40 TESSUTO - MQ 10 PELLE

*Bed with headboard in customer's fabric or leather upholstery. Hand-carved headboard and footboard (excluding sprung base 170x200cm).  
Total dimensions (W) 192 x (D) 213 x (H) 165cm*

REQUIRED FABRIC FOR THE UPHOLSTERING 7 IN H 1,40 M - LEATHER 10 SQ.

## CVL017B

Letto tutto imbottito in tessuto/pelle cliente capitonnè. Testata e pediera intagliate a mano (rete esclusa da 200x200 cm).  
Dimensioni totali L 222 x P 213 x H 168 cm

TESSUTO OCCORENTE PER L'IMBOTTITURA MT 7 IN H MT 1,40 TESSUTO - MQ 10 PELLE

*Bed with headboard in customer's fabric or leather upholstery. Hand-carved headboard and footboard (excluding sprung base 180x200cm).  
Total dimensions (W) 222 x (D) 213 x (H) 168cm*

REQUIRED FABRIC FOR THE UPHOLSTERING 7 IN H 1,40 M - LEATHER 10 SQ.

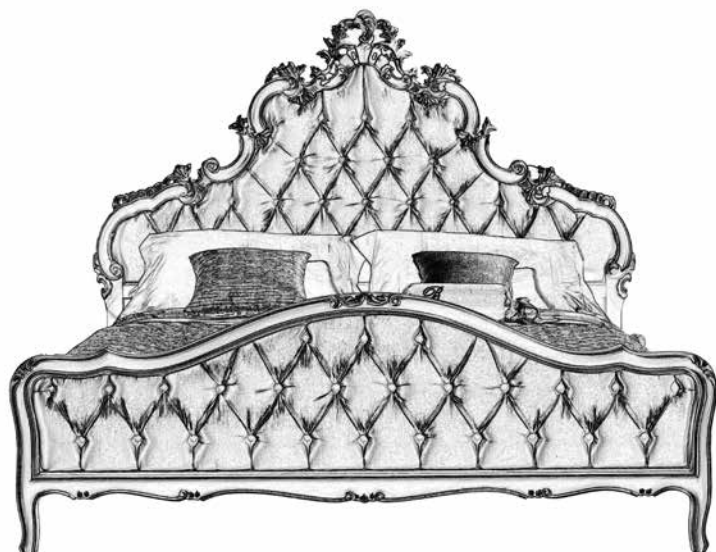





## CVL009C19P

Letto in tiglio imbottito in pelle capitonnè. Pediera alta 42 cm (rete esclusa da 150x190 cm).  
Dimensioni totali L 178 x P 204 x H 163 cm

*Bed in lime-tree wood with quilted leather upholstery. High footboard 42cm high (excluding sprung base 150x190 cm).  
Total dimensions (W) 178 x (D) 204 x (H) 163 cm*

## CVL009A20P

Letto in tiglio imbottito in pelle capitonnè. Pediera alta 42 cm (rete esclusa da 180x200 cm).  
Dimensioni totali L 208 x P 214 x H 163 cm

*Bed in lime-tree wood with quilted leather upholstery. High footboard 42cm high (excluding sprung base 180x200cm).  
Total dimensions (W) 208 x (D) 214 x (H) 163cm*

## CVL009B20P

Letto in tiglio imbottito in pelle capitonnè. Pediera alta 42 cm (rete esclusa da 165x200 cm).  
Dimensioni totali L 193 x P 214 x H 163 cm

*Bed in lime-tree wood with quilted leather upholstery. High footboard 42cm high (excluding sprung base 165x200cm).  
Total dimensions (W) 193 x (D) 214 x (H) 163cm*

## CVL009C20P

Letto in tiglio imbottito in pelle capitonnè. Pediera alta 42 cm (rete esclusa da 150x200 cm).  
Dimensioni totali L 178 x P 214 x H 163 cm

*Bed in lime-tree wood with quilted leather upholstery. High footboard 42cm high (excluding sprung base 150x200cm).  
Total dimensions (W) 178 x (D) 214 x (H) 163cm*

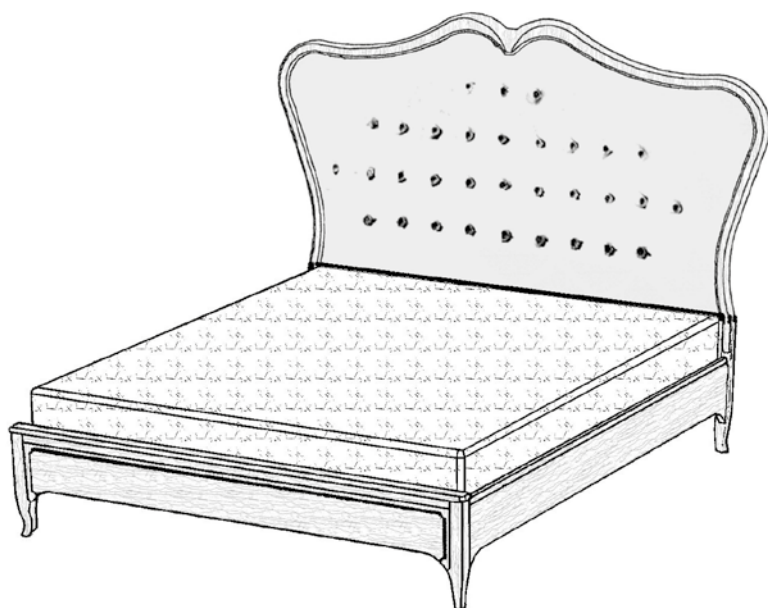





## CVL010

Letto in ciliegio con testiera con serrandine e vani apribili laterali premi e apri, con vassoi scorrevoli (rete esclusa da 165x200 cm).  
Dimensioni totali L 188 x P 260 x H 110 cm

*Bed in cherry wood with roll top headboard and push-to-open sliding drawers (excluding sprung base 165x200cm).  
Total dimensions (W) 188 x (D) 260 x (H) 110cm*

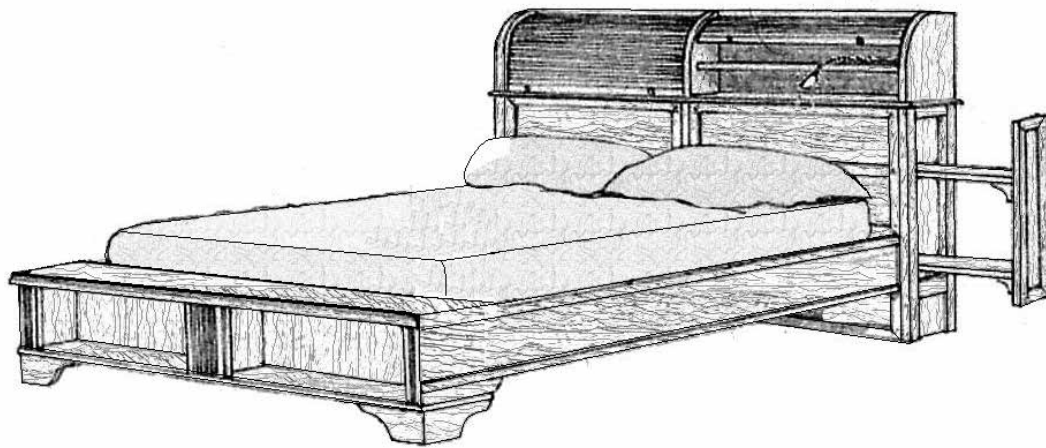

## CVL011

Letto in ciliegio con testiera con serrandine e vani apribili laterali premi e apri (rete esclusa da 165x200 cm).  
Dimensioni totali L 188 x P 239 x H 110 cm

*Bed in cherry wood with headboard and push-to-open sliding drawers (excluding sprung base 165x200cm).  
Total dimensions (W) 188 x (D) 239 x (H) 110cm*

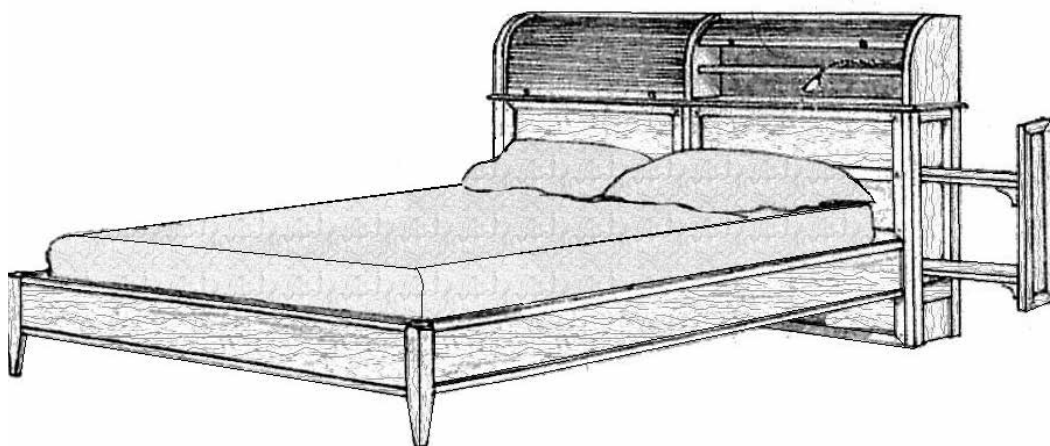





## CVL004A20

Letto in ciliegio con pediera alta 42 cm (rete esclusa da 180x200 cm).  
Dimensioni totali L 190 x P 221 x H 102 cm

*Bed in cherry wood with 42cm high footboard (excluding sprung base 180x200 cm).  
Total dimensions (W) 190 x (D) 221 x (H) 102cm*

## CVL004B20

Letto in ciliegio con pediera alta 42 cm (rete esclusa da 160x200 cm).  
Dimensioni totali L 170 x P 221 x H 102 cm

*Bed in cherry wood with 42cm high footboard (excluding sprung base 160x200 cm).  
Total dimensions (W) 170 x (D) 221 x (H) 102cm*

## CVL004C20

Letto in ciliegio con pediera alta 42 cm (rete esclusa da 150x200 cm).  
Dimensioni totali L 160 x P 221 x H 102 cm

*Bed in cherry wood with 42cm high footboard (excluding sprung base 150x200 cm).  
Total dimensions (W) 160 x (D) 221 x (H) 102 cm*

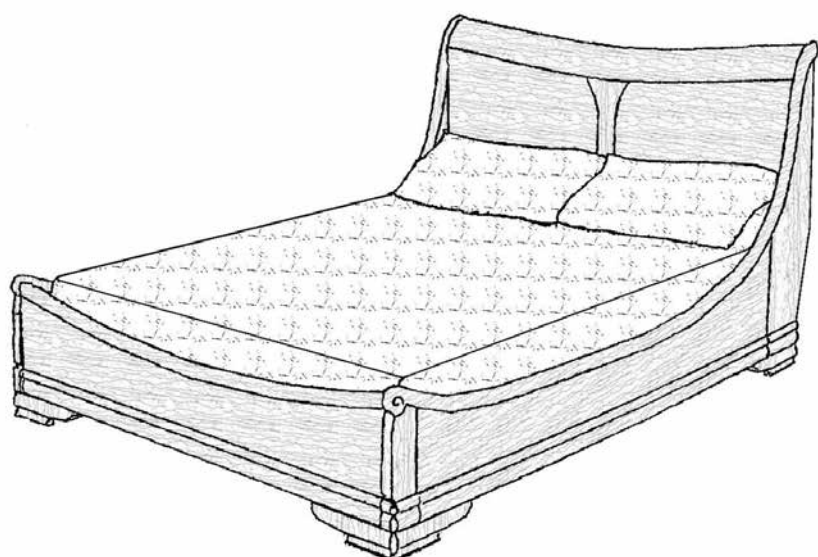





## CVL005A20

Letto in ciliegio con pediera alta 62 cm (rete esclusa da 180x200 cm).  
Dimensioni totali L 190 x P 229 x H 102 cm

*Bed in cherry wood with 62cm high footboard (excluding sprung base 180x200 cm).  
Total dimensions (W) 190 x (D) 229 x (H) 102cm*

## CVL005B20

Letto in ciliegio con pediera alta 62 cm (rete esclusa da 160x200 cm).  
Dimensioni totali L 170 x P 229 x H 102 cm

*Bed in cherry wood with 62cm high footboard (excluding sprung base 160x200 cm).  
Total dimensions (W) 170 x (D) 229 x (H) 102cm*

## CVL005C20

Letto in ciliegio con pediera alta 62 cm (rete esclusa da 150x200 cm).  
Dimensioni totali L 160 x P 229 x H 102 cm

*Bed in cherry wood with 62cm high footboard (excluding sprung base 150x200 cm).  
Total dimensions (W) 160 x (D) 229 x (H) 102 cm*

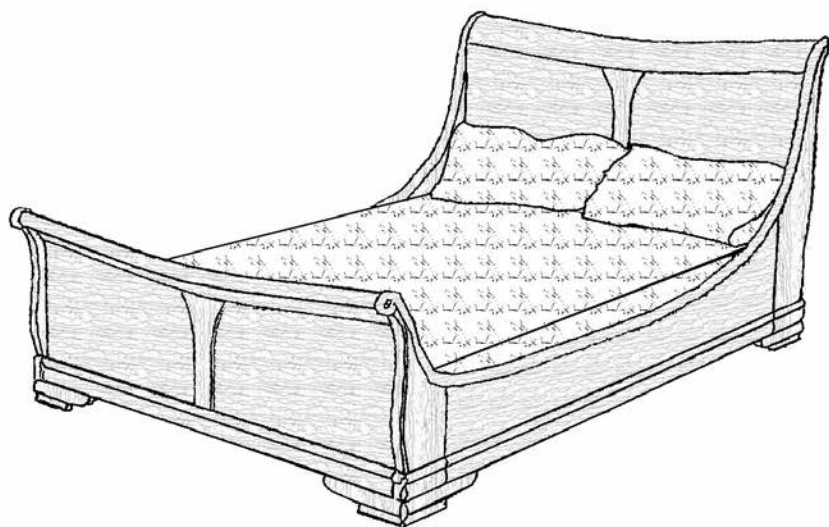





## CVL006C19

Letto in ciliegio con pediera alta 42 cm, testiera in legno (rete esclusa da 150x190 cm).  
Dimensioni totali L 163 x P 220 x H 125 cm

*Bed in cherry wood with 42cm high footboard, wooden headboard (excluding sprung base 150x190cm).  
Total dimensions (W) 163 x (D) 220 x (H) 125cm*

## CVL006A20

Letto in ciliegio con pediera alta 42 cm, testiera in legno (rete esclusa da 180x200 cm).  
Dimensioni totali L 193 x P 230 x H 125 cm

*Bed in cherry wood with 42cm high footboard, wooden headboard  
(excluding sprung base 180x200cm).  
Total dimensions (W) 193 x (D) 230 x (H) 125cm*

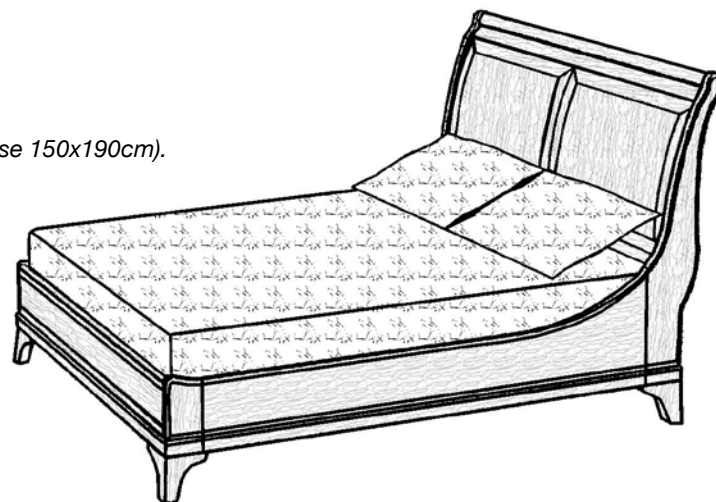

## CVL006B20

Letto in ciliegio con pediera alta 42 cm, testiera in legno (rete esclusa da 160x200 cm).  
Dimensioni totali L 173 x P 230 x H 125 cm

*Bed in cherry wood with 42cm high footboard, wooden headboard (excluding sprung base 160x200cm).  
Total dimensions (W) 173 x (D) 230 x (H) 125cm*

## CVL006C20

Letto in ciliegio con pediera alta 42 cm, testiera in legno (rete esclusa da 150x200 cm).  
Dimensioni totali L 163 x P 230 x H 125 cm

*Bed in cherry wood with 42cm high footboard, wooden headboard (excluding sprung base 150x200cm).  
Total dimensions (W) 163 x (D) 230 x (H) 125cm*

## CVL007A

Letto in ciliegio con pediera alta 91 cm, testiera in legno (rete esclusa da 180x200 cm).  
Dimensioni totali L 193 x P 235 x H 125 cm

*Bed in cherry wood with 91cm high footboard, wooden headboard  
(excluding sprung base 180x200 cm).  
Total dimensions (W) 193 x (D) 235 x (H) 125cm*

## CVL007B

Letto in ciliegio con pediera alta 91 cm, testiera in legno (rete esclusa da 160x200 cm).  
Dimensioni totali L 173 x P 235 x H 125 cm

*Bed in cherry wood with 91cm high footboard, wooden headboard  
(excluding sprung base 160x200 cm).  
Total dimensions (W) 173 x (D) 235 x (H) 125cm*

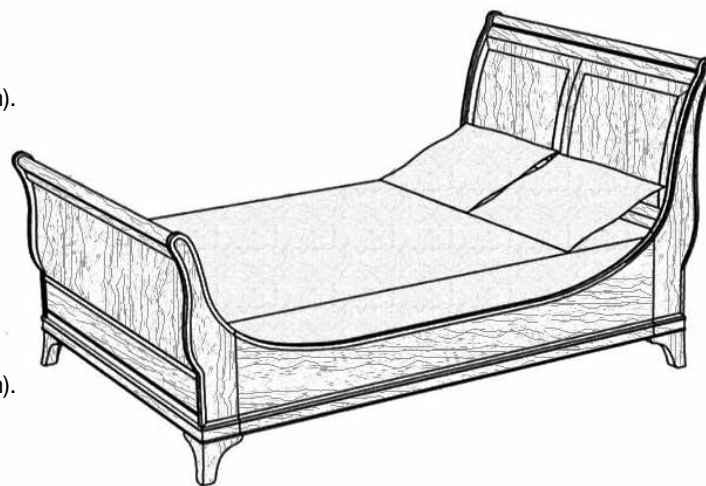

## CVL007C

Letto in ciliegio con pediera alta 91 cm, testiera in legno (rete esclusa da 150x200 cm).  
Dimensioni totali L 163 x P 235 x H 125 cm

*Bed in cherry wood with 91cm high footboard, wooden headboard (excluding sprung base 150x200 cm).  
Total dimensions (W) 163 x (D) 235 x (H) 125cm*





## DRL003

Letto con sei cassetti in ciliegio con contenitore sulla pediera, leggino escluso (rete esclusa da 165x195 cm).  
Dimensioni totali L 177 x P 235 x H 104 cm

*Bed with six drawers in cherry wood and container in the footboard, excluding reading stand (excluding sprung base 165x195cm).  
Total dimensions (W) 177 x (D) 235 x (H) 104cm*

## DRL003G

Letto con sei cassetti in ciliegio con contenitore sulla pediera, leggino escluso (rete esclusa da 180x195 cm).  
Dimensioni totali L 192 x P 235 x H 104 cm

*Bed with six drawers in cherry wood and container in the footboard, excluding reading stand (excluding sprung base 180x195cm).  
Total dimensions (W) 192 x (D) 235 x (H) 104cm*

## DRZ001

Leggino per cassetto centrale (al momento dell'ordine specificare se inserirlo a destra oppure a sinistra).

*Reading stand for central drawer (when placing the order, please specify whether it has to be placed in the right or in the left drawer).*

## AMZ002

Telaio in abete.  
Dimensioni totali L 165 x P 195 x H 4 cm

*Pine frame.  
Total dimensions (W) 165 x (D) 195 x (H) 4cm*

## AMZ007

Telaio in abete.  
Dimensioni totali L 180 x P 195 x H 4 cm

*Pine frame.  
Total dimensions (W) 180 x (D) 195 x (H) 4cm*







## CVL013T

Testata letto in ciliegio massello interamente intagliata a mano secondo le antiche tradizioni dell'ebanisteria veneta.  
Dimensioni totali L 190 x P 6 x H 190 cm

*Solid cherry wood headboard carved entirely by hand in keeping with the ancient traditions of Venetian cabinet makers.  
Total dimensions (W) 190 x (D) 6 x (H) 190cm*

## CVL013G

Sommier in ciliegio con gambe intagliate a mano per rete da 180x200 cm  
Dimensioni totali L 185 x P 205 x H 35 cm

*Sommier in cherry wood with legs carved by hand for sprung base 180x200cm  
Total dimensions (W) 185 x (D) 205 x (H) 35cm*

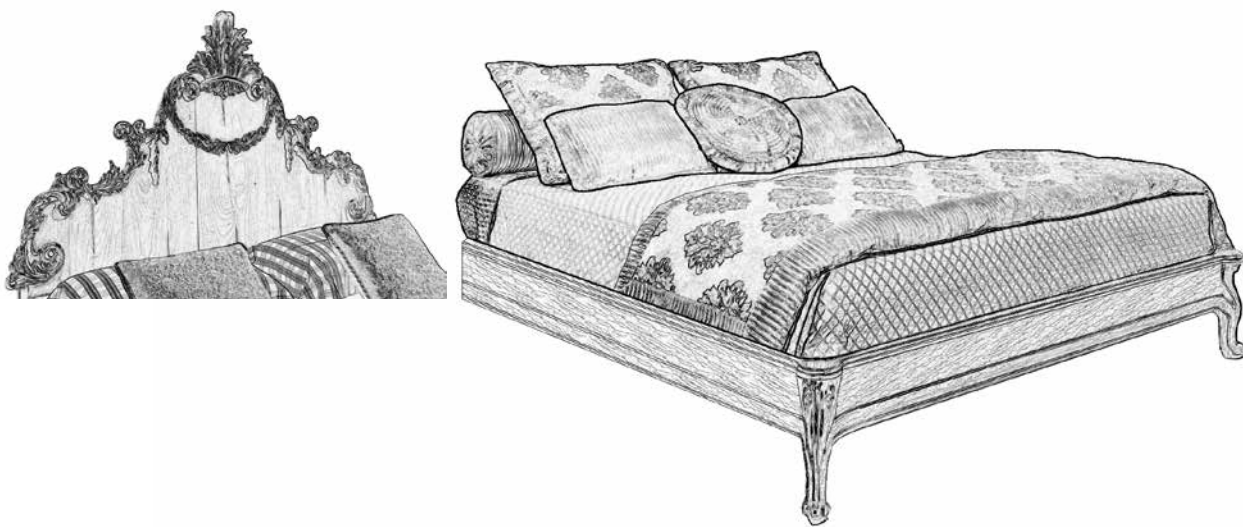







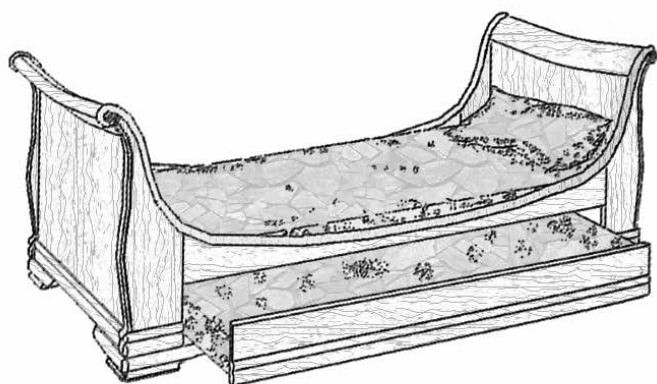

## CVL001

Letto in ciliegio con rete estraibile su ruote da 180 x 90 (rete superiore esclusa da 90 x 200). Dimensioni totali L 230 x P 99 x H 82 cm

*Bed in cherry with removable bed-springs on wheels from 180 x 90cm. (superior bed-springs excluded from 90 x 200). Total dimensions (W) 230, (D) 99, (H) 82 cm*



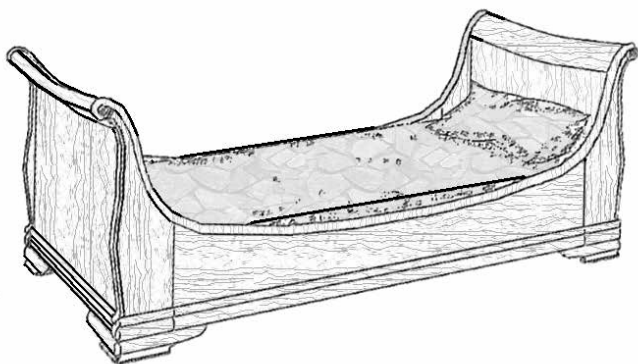

## CVL002

Letto in ciliegio (rete esclusa da 90 x 200 cm). Smontabile.  
Dimensioni totali L 230 x P 99 x H 82 cm

*Dismountable bed in cherry (bed springs excluded from 90 x 200 cm).  
Total dimensions (W) 230, (D) 99, (H) 82 cm*







## CVN016

Comodino in ciliegio con un cassetto e con vano a giorno.  
Dimensioni totali L 66 x P 35 x H 71 cm

*Bedside table in cherry wood with one drawer and open shelving.  
Total dimensions (W) 66 x (D) 35 x (H) 71 cm*



## CVN017

Comodino in ciliegio con due cassetti.  
Dimensioni totali L 66 x P 35 x H 71 cm

*Bedside table in cherry wood with two drawers.  
Total dimensions (W) 66 x (D) 35 x (H) 71 cm*







## CVN020

Comodino in ciliegio con tre cassetti. Top con riquadratura superiore e fianchi con pannello bugnato.  
Dimensioni totali L 52 x P 37 x H 55 cm

*Beside table in cherry wood with three drawers. Top with upper framing and sides with raised panels.  
Total dimensions (W) 52 x (D) 37 x (H) 55cm*

## CVN002

Comodino in ciliegio con tre cassetti. Top con riquadratura superiore e fianchi con pannello bugnato.  
Dimensioni totali L 60 x P 37 x H 66 cm

*Beside table in cherry wood with three drawers. Top with upper framing and sides with raised panels.  
Total dimensions (W) 60 x (D) 37 x (H) 66cm*



## CVN021

Comodino in ciliegio con un cassetto ed un ripiano spostabile su scaletta in legno, fianchi con pannello bugnato, top con riquadratura superiore. Ripiano e schienale in frassino massiccio.  
Dimensioni totali L 52 x P 37 x H 66 cm

*Beside table in cherry wood with a drawer and an adjustable shelf on a wooden rack, sides with raised panels, top with upper framing. Shelf and back panel in solid ash.  
Total dimensions (W) 52 x (D) 37 x (H) 66cm*

## CVN003

Comodino in ciliegio con un cassetto ed un ripiano spostabile su scaletta in legno, fianchi con pannello bugnato, top con riquadratura superiore. Ripiano e schienale in frassino massiccio.  
Dimensioni totali L 60 x P 37 x H 66 cm

*Beside table in cherry wood with a drawer and an adjustable shelf on a wooden rack, sides with raised panels, top with upper framing. Shelf and back panel in solid ash.  
Total dimensions (W) 60 x (D) 37 x (H) 66cm*







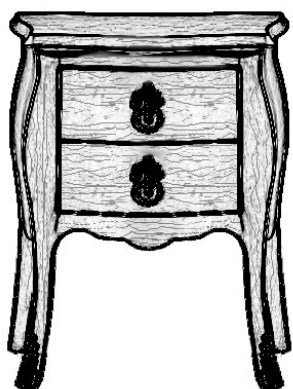

## CVN001L

Comodino in tiglio con fregi in ottone.  
Dimensioni totali L 49 x P 29 x H 61 cm

*Bedside table in lime wood with embellishments in brass.  
Total dimensions (W) 49, (D) 29, (H) 61 cm*





## CVN004

Comodino in ciliegio con 2 cassetti e top riquadrato. Preziosa maniglia e decori in ottone.

Dimensioni totali L 65 x P 40 x H 65 cm

*Bedside table in cherry with 2 drawers and squared top. Precious handle and decoration in brass.*

*Total dimensions (W) 65, (D) 40, (H) 65 cm*



## CVN022

Comodino in ciliegio con tre cassetti.  
Dimensioni totali L 60 x P 37 x H 71 cm

*Bedside table in cherry wood with three drawers.  
Total dimensions (W) 60 x (D) 37 x (H) 71cm*



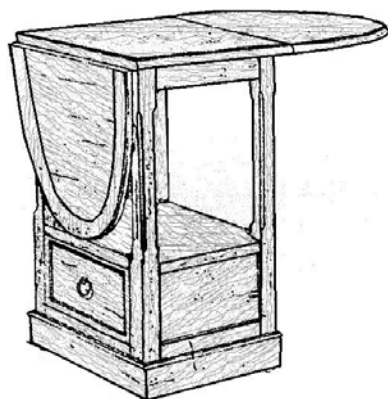
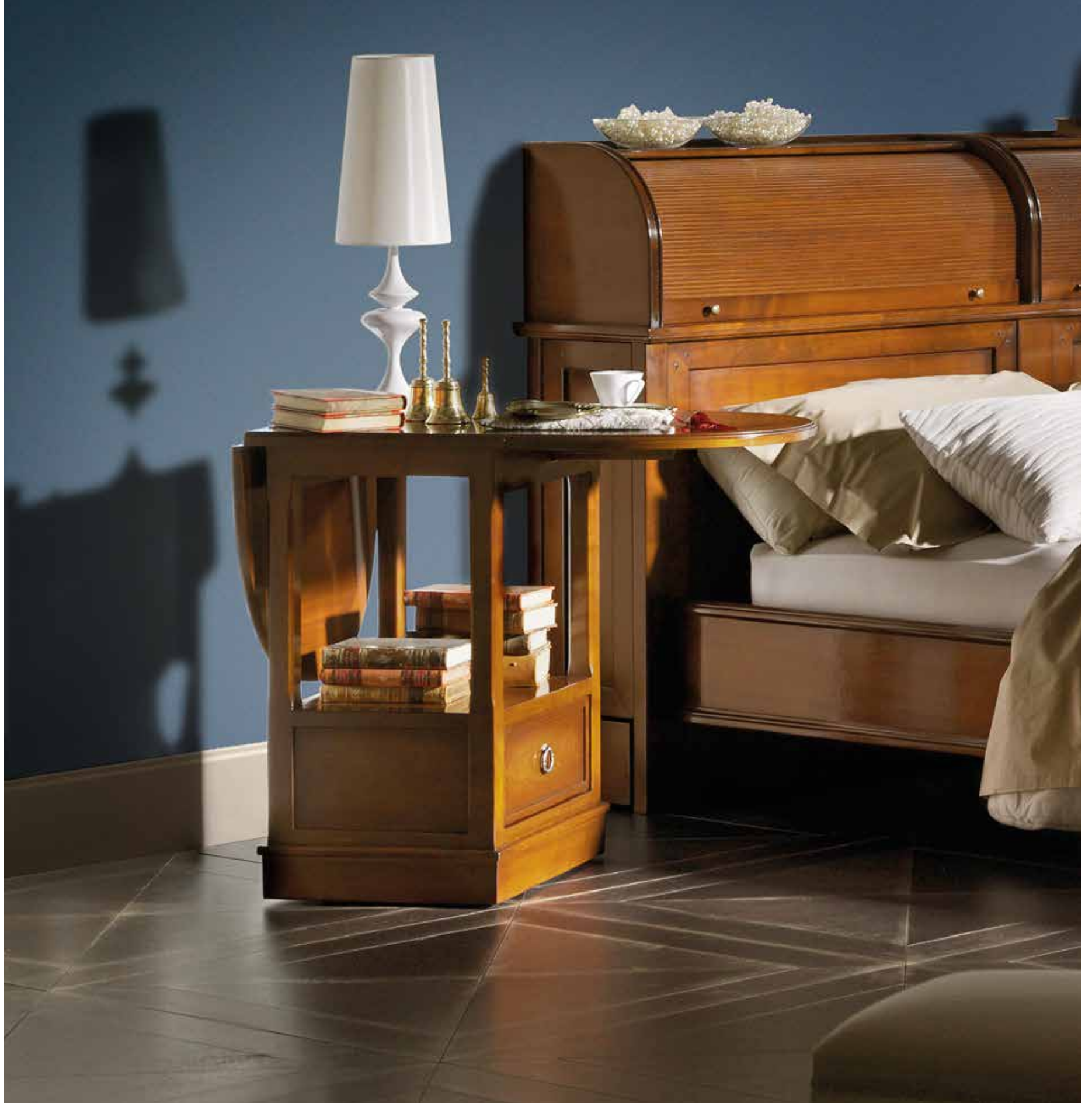

## CVN023

Comodino in ciliegio con un cassetto e alette laterali piegabili (dimensione aperto 51 x 116 x 70 cm), con ruote.  
Dimensioni totali L 51 x P 41 x H 70 cm

*Bedside table in cherry wood with one drawer and fold-out wings (open dim. 51 x 116 x 70 cm), with wheels.  
Total dimensions (W) 51 x (D) 41 x (H) 70cm*



## CVN024

Comodino in ciliegio con tre cassetti.  
Dimensioni totali L 64,5 x P 39,5 x H 66 cm

*Bedside table in cherry wood with three drawers.  
Total dimensions (W) 64,5 x (D) 39,5 x (H) 66cm*





## CVN025

Comodino in ciliegio sagomato con due cassetti. Montanti e maniglie intagliati a mano secondo le antiche tradizioni dell'ebanisteria veneta. Dimensioni totali L 63,5 x P 41 x H 65 cm

*Contoured bedside table in cherry wood with two drawers. Uprights and handles carved by hand in keeping with the ancient traditions of Venetian cabinet makers. Total dimensions (W) 63,5 x (D) 41 x (H) 65cm*

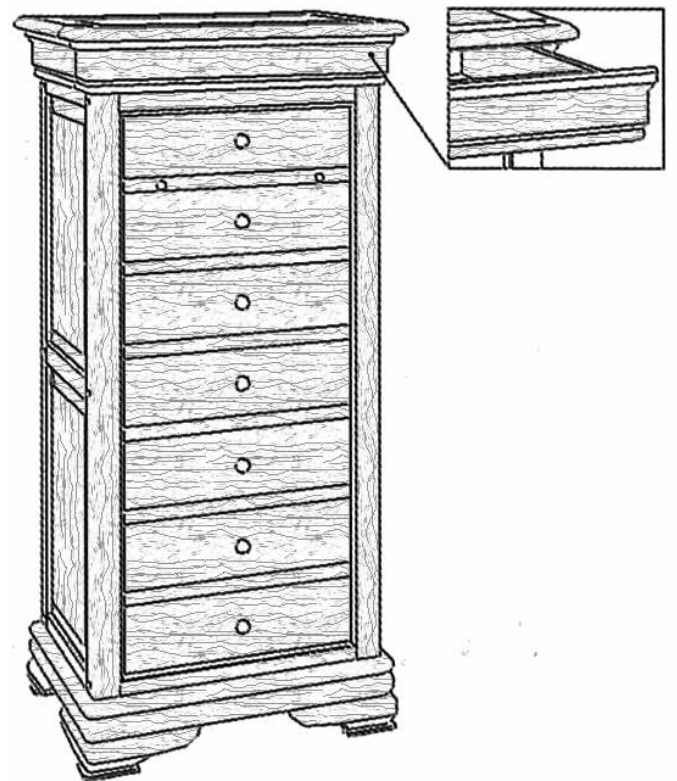

## CVS002

Settimanale in ciliegio con tiretto estraibile ed 8 cassetti. Top con riquadratura superiore e fianchi con pannelli bugnati. Dimensioni totali L 70 x P 45 x H 140 cm

*Tallboy in cherry with pull-out disappearing top and 8 drawers. Squared top surface and sides with ashlar-worked pannels. Total dimensions (W) 70, (D) 45, (H) 140 cm*



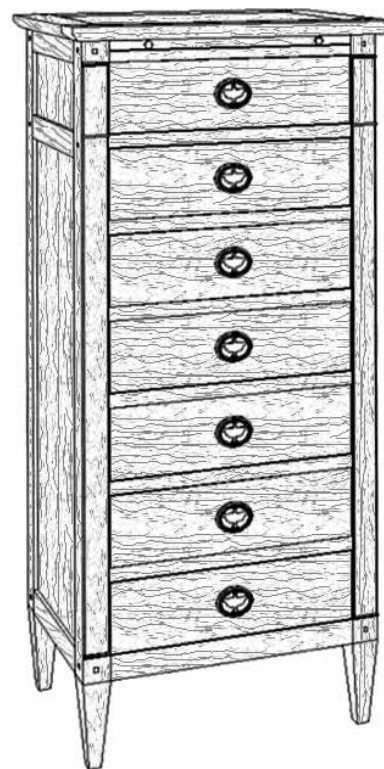

## CVS003

Settimanale in ciliegio con tiretto estraibile con 7 cassetti.  
Top e fianchi riquadrati. Dimensioni totali  
L 61 x P 43 x H 134 cm

*Tallboy in cherry with pull-out disappearing top and 7  
drawer. Top and side pannels are squared.  
Total dimensions (W) 61, (D) 43, (H) 134 cm*

# CVS009

Settimanale in ciliegio con cinque cassetti e ribalta con serrandina, scanalature sui montanti e gambe tornite.  
Dimensioni totali L 60 x P 47 x H 153 cm

*Tallboy in cherry wood with five drawers and drop leaf desk with roll top; with grooves on the uprights and turned legs.  
Total dimensions (W) 60, (D) 47, (H) 153 cm*













## CVM001

Comò in ciliegio, cassetti con guide metalliche ad estrazione totale, con fregi in ottone. Dimensioni totali L 158 x P 57 x H 105 cm

*Chest of drawers in cherry, completely extractable drawers with metal runners, embellishments in brass. Total dimensions (W) 158, (D) 57, (H) 105 cm*

## CVM001L

Comò in tiglio, cassetti con guide metalliche ad estrazione totale, con fregi in ottone. Dimensioni totali L 158 x P 57 x H 105 cm

*Chest of drawers in lime, completely extractable drawers with metal runners, embellishments in brass. Total dimensions (W) 158, (D) 57, (H) 105 cm*



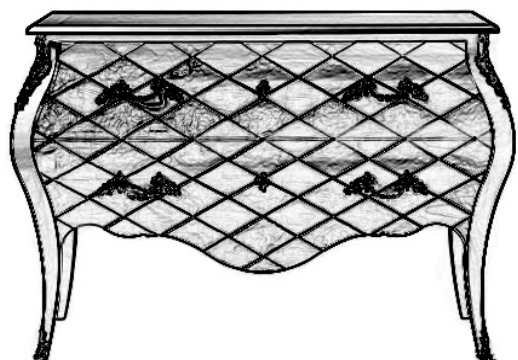

## CVM008

Comò in tiglio, cassetti con guide metalliche ad estrazione totale, con fregi in ottone. Frontale dei cassetti con intagli a rombo. Dimensioni totali L 158 x P 57 x H 105 cm

*Bedside table in lime-tree wood, drawers with metal runners for full pull-out, with brass features. Drawer fronts faced with diamond shaped intaglio. Total dimensions (W) 158 x (D) 57 x (H) 105cm*



## CVM002

Comò in ciliegio 3 cassetti con piano in pelle ribaltabile ed estraibile, all'interno 4 cassetti (pelle occorrente mq 0,65). Finto cassetto centrale a ribalta. Dimensioni totali L 95 x P 48 x H 117 cm

*Chest of drawers in cherry with 3 drawers and completely extractable folding top in leather, inside 4 drawers (leather needed 0,65 sq m). Central fake foldable drawer. Total dimensions (W) 95, (D) 48, (H) 117 cm*





## CVM003

Comò in ciliegio 2 cassetti con piano in pelle ribaltabile ed estraibile, all'interno 4 cassetti (pelle occorrente mq.0,65). Finto cassetto superiore a ribalta. Dimensioni totali L 95 x P 48 x H 94 cm

*Chest of drawers in cherry 2 drawers with foldable, completely extractable top in leather, inside 4 drawers (leather needed 0,65 sq m). Foldable fake top drawer. Total dimensions (W) 95, (D) 48, (H) 94 cm*



## CVM004

Comò in ciliegio con 3 cassetti e top riquadrato. Preziose maniglie e decorazioni in ottone. Dimensioni totali L 135 x P 56 x H 93 cm

*Chest of drawers in cherry with 3 drawers and squared top. Precious handles and decorations in brass.  
Total dimensions (W) 135, (D) 56, (H) 93 cm*





## CVM005

Comò in ciliegio con 3 cassetti e top riquadrato. Preziose maniglie e decorazioni in ottone. Dimensioni totali L 120 x P 56 x H 87 cm

*Chest of drawers in cherry with 3 drawers and squared top. Precious handles brass decoration.*

*Total dimensions (W) 120, (D) 56, (H) 87 cm*

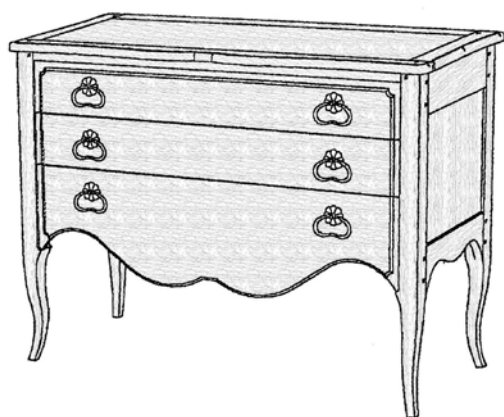

## CVM016

Comò in ciliegio con tre cassetti.  
Dimensioni totali L 137 x P 55 x H 104 cm

*Chest of drawers in cherry wood with three drawers.  
Total dimensions (W) 137 x (D) 55 x (H) 104cm*





## CVM022

Comò in ciliegio con sei cassetti e con piano ribaltabile.  
All'interno secretaire con 4 cassettoni.  
Dimensioni totali L 133 x P 53 x H 117 cm

*Chest of drawers in cherry wood with six drawers and a fold-down writing desk with four small drawers.  
Total dimensions (W) 133 x (D) 53 x (H) 117cm*

## CVM017

Comò in ciliegio/noce con 3 cassetti.  
Dimensioni totali L 132 x P 52 x H 91 cm

*Chest of drawers in cherry wood with three drawers.  
Total dimensions (W)132 x (D) 52 x (H) 91cm*

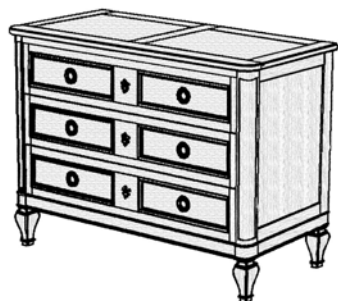

## CVM018

Comò in ciliegio/noce con 4 cassetti.  
Dimensioni totali L 132 x P 52 x H 112 cm

*Chest of drawers in cherry wood with four drawers.  
Total dimensions (W)132 x (D) 52 x (H) 112cm*



## CVN018

Comodino in ciliegio/noce con 2 cassetti.  
Dimensioni totali L 60 x P 37 x H 63 cm

*Bedside table in cherry wood with two drawers.  
Total dimensions (W) 60 x (D) 37 x (H) 63cm*







## CVM019

Comò in ciliegio con 4 cassetti. Top con riquadratura superiore e fianchi con pannello bugnato.  
Dimensioni totali L 120 x P 51 x H 86 cm

*Chest of drawers in cherry wood with four drawers. Top with upper framing and sides with raised panels.  
Total dimensions (W)120 x (D) 51 x (H) 86cm*

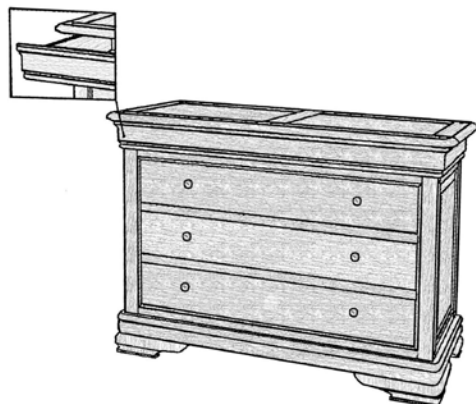

## CVM020

Comò in ciliegio con 4 cassetti. Top con riquadratura superiore e fianchi con pannello bugnato.  
Dimensioni totali L 135 x P 51 x H 95 cm

*Chest of drawers in cherry wood with four drawers. Top with upper framing and sides with raised panels.  
Total dimensions (W)135 x (D) 51 x (H) 95cm*

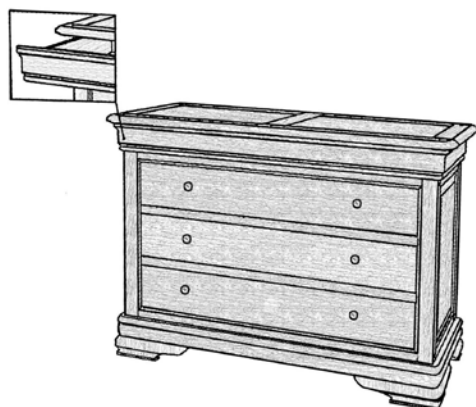

## CVM021

Comò in ciliegio con 3 cassetti e parte superiore apribile con specchio molato e piccoli porta oggetti al suo interno.  
Top con riquadratura superiore e fianchi con pannello bugnato.  
Dimensioni totali L 120 x P 51 x H 86 cm

*Chest of drawers in cherry wood with three drawers and with a top that can be opened to display a bevelled mirror and counter top organizer. Top with upper framing and sides with raised panels.  
Total dimensions (W)120 x (D) 51 x (H) 86cm*

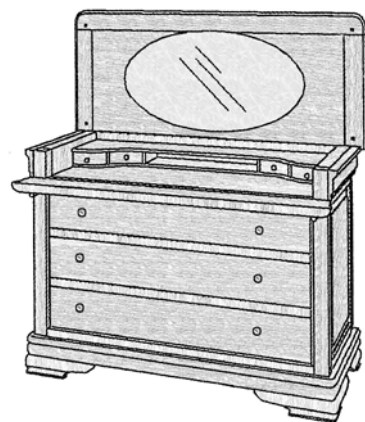







## CVM024

Comò in ciliegio con tre cassetti.  
Dimensioni totali L 143 x P 53,5 x H 96,5 cm

*Chest of drawers in cherry wood with three drawers.  
Total dimensions (W) 143 x (D) 53,5 x (H) 96,5cm*





## CVM025

Comò in ciliegio sagomato con tre cassetti. Montanti e maniglie intagliati a mano secondo le antiche tradizioni dell'ebanisteria veneta.  
Dimensioni totali L 151 x P 58 x H 104 cm

*Contoured chest of drawers in cherry wood with three drawers. Uprights and handles carved by hand in keeping with the ancient traditions of Venetian cabinet makers.*  
Total dimensions (W) 151 x (D) 58 x (H) 104cm

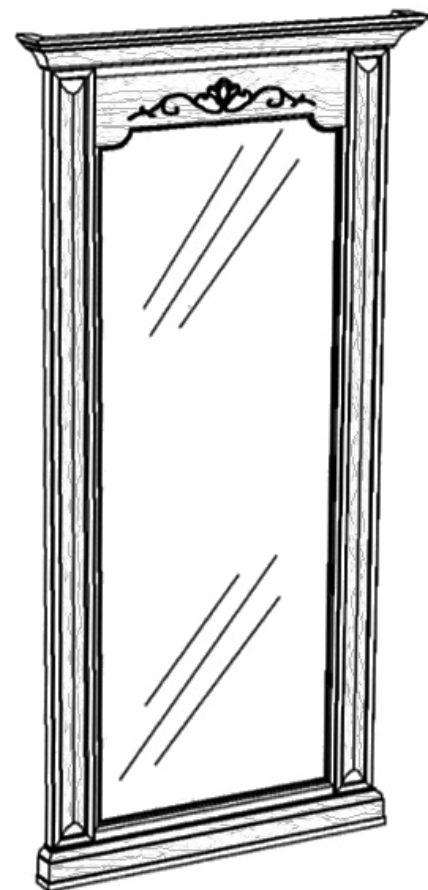

## CV0001

Specchiera in ciliegio con 2 larghi montanti laterali bugnati. Decoro in legno intagliato a mano e specchio molato. Dimensioni totali L 109 x P 11 x H 219 cm

*Mirror in cherry with 2 wide ashlar-worked lateral uprights. Decoration in wood inlaid by hand with bevelled mirror. Total dimensions (W) 109, (D) 11, (H) 219 cm*



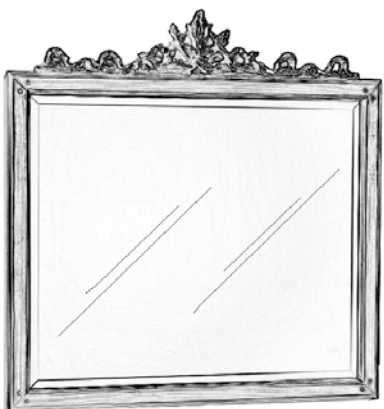

## CV0005

Specchiera in ciliegio con intaglio superiore.  
Dimensioni totali L 106 x P 5,5 x H 106 cm

*Mirror in cherry wood with upper carving.  
Total dimensions (W) 106 x (D) 5.5 x (H) 106cm*

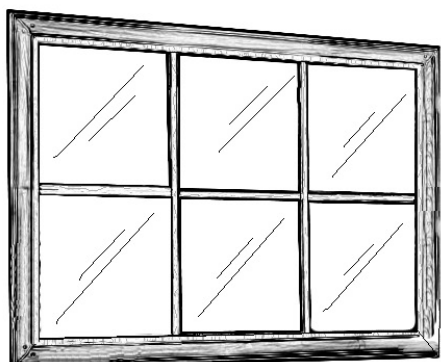

## CV0006

Specchiera in ciliegio.  
Dimensioni totali L 140 x P 5x H 100 cm

*Mirror in cherry wood.  
Total dimensions (W) 140 x (D) 5 x (H) 100cm*



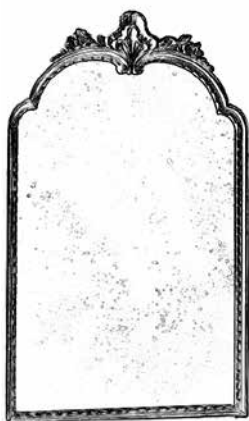

## **CV0007**

Specchiera in ciliegio sagomata e con intaglio superiore.  
Dimensioni totali L 82 x P 5x H 133 cm

*Contoured mirror in cherry wood with upper carving.  
Total dimensions (W) 82 x (D) 5 x (H) 133cm*



## CV0003 ARG

Specchiera in tiglio intagliato a mano in foglia argento patinato sfumato.  
Specchio molato. Dimensioni totali L 86 x P 4 x H 111 cm

*Mirror in lime inlaid by hand in antiqued, shaded silver leaf. Bevelled mirror.  
Total dimensions (W) 86, (D) 4, (H) 111 cm*





## CV0003 ORO

Specchiera in tiglio intagliato a mano in foglia oro patinato sfumato.  
Specchio molato. Dimensioni totali L 86 x P 4 x H 111 cm

*Mirror in lime inlaid by hand in antiqued, shaded gold leaf. Bevelled mirror.  
Total dimensions (W) 86, (D) 4, (H) 111 cm*

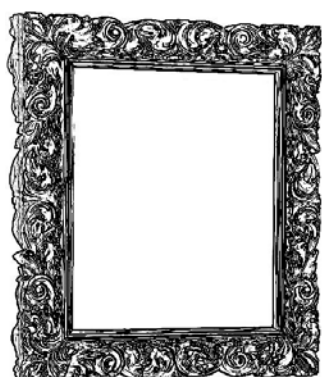

## CV0002

Specchiera in tiglio intagliato a mano in moka e oro patinato. Specchio molato. Dimensioni totali L 90 x P 2,5 x H 105 cm

*Mirror in lime inlaid by hand in coffee and antiqued gold. Bevelled mirror. Total dimensions (W) 90, (D) 2.5, (H) 105 cm*



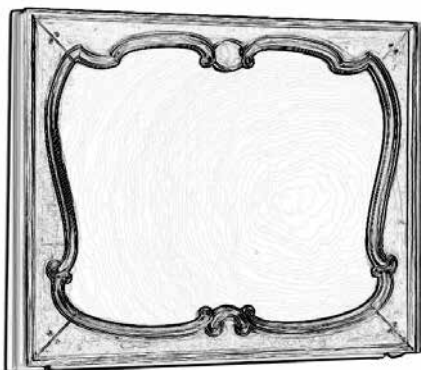

## **CV0004**

Specchiera in ciliegio intagliato a mano e con interno sagomato.  
Dimensioni totali L 120 x P 4 x H 100 cm

*Mirror in cherry inlaid by hand, the inside is shaped.  
Total dimensions (W) 120, (D) 4, (H) 100 cm*







# CVP001

Armadio 2/A Scorr. Specchio inciso / legno in ciliegio con montanti scanalati.  
Dotazione interna per vano: 1 ripiano e 2 tubi appendiabito.  
Dimensioni totali L 360 x P 64,4 x H 258 cm

*Double Wardrobe with sliding doors. Engraved mirror / cherry wood with fluted uprights.  
Compartment layout: one shelf and two hanging rails.  
Total dimensions (W)360 x (D) 64,4 x (H) 258cm*

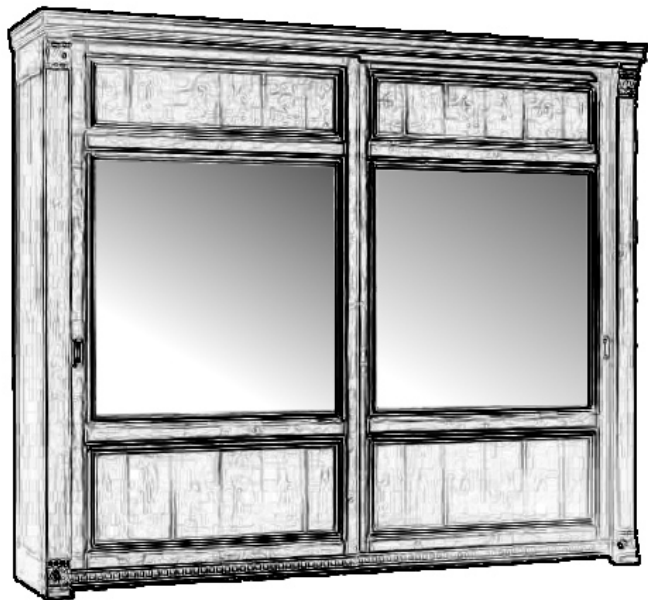





# CVB008

Mobiletto toilette in ciliegio. Frontale a ribalta e parte superiore apribile con specchio molato e piccoli porta oggetti al suo interno.  
Dimensioni totali L 75 x P 43 x H 84 cm

*Dressing table in cherry. Downward opening front and top opens upwards with bevelled mirror and small internal space for jewellery.*  
*Total dimensions (W) 75, (D) 43, (H) 84 cm*







seat  
**seduta**









## SFS003

Sedia in faggio imbottita in tessuto con gambe e traverso superiore intagliato a mano.  
Dimensioni totali  
L 53 x P 51 x H 106 cm

*Chair in beech upholstered in fabric with legs and upper beam inlaid by hand. Total dimensions (W) 53, (D) 51, (H) 106 cm*

## SFP003

Sedia in faggio imbottita in pelle con gambe e traverso superiore intagliato a mano.  
Dimensioni totali  
L 53 x P 51 x H 106 cm

*Chair in beech upholstered in leather with legs and upper beam inlaid by hand. Total dimensions (W) 53, (D) 51, (H) 106 cm*

## SFB003

Sedia in faggio imbottita in bianco o tessuto o pelle cliente con gambe e traverso superiore intagliato a mano.  
TESSUTO OCCORRENTE PER L'IMBOTTITURA  
MT. 1,1 IN H. MT 1,40 , PELLE 1,5 MQ.  
Dimensioni totali L 53 x P 51 x H 106 cm

*Chair in beech upholstered in white lining fabric or customer's fabric or leather with legs and upper beam inlaid by hand.  
FABRIC NEEDED FOR THE UPHOLSTERING  
1,1 MT., H. MT. 1,40 , LEATHER 1,5 SQ.M.  
Total dimensions (W) 53, (D) 51, (H) 106 cm*





## SFS003C

Sedia in faggio con sedile e schienale imbottiti in tessuto con schienale in capitonnè. Gambe e traverso superiore intagliati a mano. Dimensioni totali L 53 x P 51 x H 106 cm

*Chair in beech upholstered in fabric, with back capitonnè, legs and upper beam inlaid by hand.*  
Total dimensions  
(W) 53 x (D) 51 x (H) 106cm

## SFP003C

Sedia in faggio con sedile e schienale imbottiti in pelle con schienale in capitonnè. Gambe e traverso superiore intagliati a mano. Dimensioni totali L 53 x P 51 x H 106 cm

*Chair in beech upholstered in leather, with back capitonnè, legs and upper beam inlaid by hand.*  
Total dimensions  
(W) 53 x (D) 51 x (H) 106cm

## SFB003C

Sedia in faggio con sedile e schienale imbottito in bianco o tessuto/pelle cliente con schienale in capitonnè. Gambe e traverso superiore intagliato a mano. TESSUTO OCCORRENTE PER L'IMBOTTITURA MT 1,20 IN H MT 1,40, PELLE 1,50 MQ  
Dimensioni totali L 53 x P 51 x H 106 cm

*Chair in beech upholstered in customer's fabric/leather, with back capitonnè, legs and upper beam inlaid by hand. FABRIC REQUIRED FOR UPHOLSTERING MT 1,20, H MT 1,40 / LEATHER 1,5 SQ.*  
Total dimension (W) 53 x (D) 51 x (H) 106cm

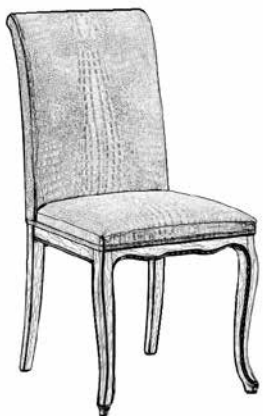

## SFS010

Sedia in faggio tutta imbottita in tessuto. Gambe chippendale. Dimensioni totali L 50 x P 60 x H 99 cm

*Chair in beech upholstered in fabric with chippendale legs. Total dimensions (W) 50 x (D) 60 x (H) 99cm*

## SFP010

Sedia in faggio tutta imbottita in pelle. Gambe chippendale. Dimensioni totali L 50 x P 60 x H 99 cm

*Chair in beech upholstered in leather with chippendale legs. Total dimensions (W) 50 x (D) 60 x (H) 99cm*

## SFB010

Sedia in faggio tutta imbottita in bianco o in tessuto/pelle cliente. Gambe chippendale. TESSUTO OCCORRENTE PER L'IMBOTTITURA MT 1,50 IN H MT 1,40, PELLE 2 MQ Dimensioni totali L 50 x P 60 x H 99 cm

*Chair in beech upholstered in white or customer's fabric/leather with chippendale legs. FABRIC REQUIRED FOR UPHOLSTERING MT 1.5 H MT 1.40 / LEATHER 2 SQ. Total dimensions (W) 50 x (D) 60 x (H) 99cm*





## SFS012

Sedia in faggio con sedile e schienale imbottiti in tessuto. Gambe e traverso superiore intagliati a mano. Dimensioni totali L 47 x P 43 x H 104 cm

*Chair in beech with seat and back upholstered in fabric. Legs and upper beam inlaid by hand. Total dimensions (W) 47 x (D) 43 x (H) 104cm*

## SFP012

Sedia in faggio con sedile e schienale imbottiti in pelle. Gambe e traverso superiore intagliati a mano. Dimensioni totali L 47 x P 43 x H 104 cm

*Chair in beech with seat and back upholstered in leather. Legs and upper beam inlaid by hand. Total dimensions (W) 47 x (D) 43 x (H) 104cm*

## SFB012

Sedia in faggio con sedile e schienale imbottiti in bianco o in tessuto/pelle cliente. Gambe e traverso superiore intagliati a mano. TESSUTO OCCORRENTE PER L'IMBOTTITURA MT 1,30 IN H MT 1,40, PELLE 1,80 MQ. Dimensioni totali L 47 x P 43 x H 104 cm

*Chair in beech with seat and back upholstered in white or customer's fabric/leather. Legs and upper beam inlaid by hand. FABRIC REQUIRED FOR UPHOLSTERING MT 1.3 H MT 1.40 / LEATHER 1.8 SQ. Total dimensions (W) 47 x (D) 43 x (H) 104cm*



## SFS017

Capotavola in faggio con sedile e schienale imbottiti in tessuto. Gambe e traverso superiore intagliati a mano. Dimensioni totali L 57 x P 49 x H 113 cm

*Chair in beech with seat and back upholstered in fabric. Legs and upper beam inlaid by hand.*  
Total dimensions  
(W) 57 x (D) 49 x (H) 113cm

## SFP017

Capotavola in faggio con sedile e schienale imbottiti in pelle. Gambe e traverso superiore intagliati a mano. Dimensioni totali L 57 x P 49 x H 113 cm

*Chair in beech with seat and back upholstered in leather. Legs and upper beam inlaid by hand.*  
Total dimensions  
(W) 57 x (D) 49 x (H) 113cm

## SFB017

Capotavola in faggio con sedile e schienale imbottiti in bianco o in tessuto/pelle cliente. Gambe e traverso superiore intagliati a mano. TESSUTO OCCORRENTE PER L'IMBOTTITURA MT 1,50 IN H MT 1,40, PELLE 2 MQ. Dimensioni totali L 57 x P 49 x H 113 cm

*Chair in beech with seat and back upholstered in white or customer's fabric/leather. Legs and upper beam inlaid by hand.*  
FABRIC REQUIRED FOR UPHOLSTERING MT 1.5 H MT 1.40 / LEATHER 2 SQ.  
Total dimensions (W) 57 x (D) 49 x (H) 113cm





## SFS019

Sedia in ciliegio con sedile e schienale imbottiti in tessuto.  
Dimensioni totali  
L 53 x P 51 x H 104 cm

*Chair in cherry wood with seat and back upholstered in fabric.  
Total dimensions  
(W) 53 x (D) 51 x (H) 104cm*

## SFP019

Sedia in ciliegio con sedile e schienale imbottiti in pelle.  
Dimensioni totali  
L 53 x P 51 x H 104 cm

*Chair in cherry wood with seat and back upholstered in leather.  
Total dimensions  
(W) 53 x (D) 51 x (H) 104cm*

## SFB019

Sedia in ciliegio con sedile e schienale imbottiti in bianco o in tessuto/pelle cliente.  
TESSUTO OCCORRENTE PER L'IMBOTTITURA  
MT 1,40 IN H MT 1,40, PELLE 1,80 MQ  
Dimensioni totali L 53 x P 51 x H 104 cm

*Chair in cherry wood with seat and back upholstered in white or customer's fabric/leather. FABRIC REQUIRED FOR UPHOLSTERING MT 1.4 H MT 1.40 / LEATHER 1.8 SQ.  
Total dimensions (W) 53 x (D) 51 x (H) 104cm*

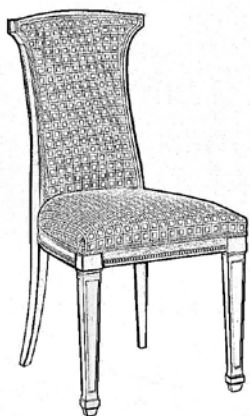

## CVG001T

Sedia in ciliegio con perline decorative in legno, sedile e schienale imbottito in tessuto.  
Dimensioni totali  
L 52 x P 59 x H 102 cm

*Chair in cherry wood with beaded decoration in wood, seat and back-rest upholstered in fabric.*  
Total dimensions  
(W) 52, (D) 59, (H) 102 cm

## CVG001P

Sedia in ciliegio con perline decorative in legno, sedile e schienale imbottito in pelle.  
Dimensioni totali  
L 52 x P 59 x H 102 cm

*Chair in cherry wood with beaded decoration in wood, seat and back-rest upholstered in leather.*  
Total dimensions  
(W) 52, (D) 59, (H) 102 cm

## CVG001B

Sedia in ciliegio con perline decorative in legno, sedile e schienale imbottito in bianco o tessuto/pelle cliente. TESSUTO OCCORRENTE PER L'IMBOTTITURA MT. 1,40 IN H. MT 1,40, PELLE 2 MQ. Dimensioni totali  
L 52 x P 59 x H 102 cm

*Chair in cherry wood with beaded decoration in wood, seat and back-rest upholstered in white or customer's fabric/leather. FABRIC NEEDED FOR THE UPHOLSTERING 1,40 MT. H. MT 1,40, LEATHER 2 SQ.M.*  
Total dimensions (W) 52, (D) 59, (H) 102 cm



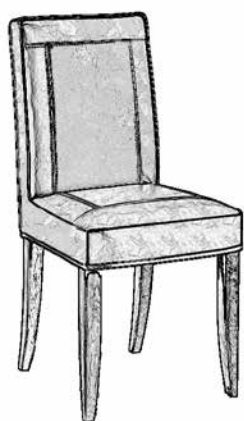

## CVG002T

Sedia in ciliegio con sedile e schienale imbottito in tessuto con particolari cuciture. Dimensioni totali L 52 x P 50 x H 99 cm

*Chair in cherry wood with seat and back-rest upholstered in fabric with special stitching.*  
Total dimensions (W) 52, (D) 50, (H) 99 cm

## CVG002P

Sedia in ciliegio con sedile e schienale imbottito in pelle con particolari cuciture. Dimensioni totali L 52 x P 50 x H 99 cm

*Chair in cherry wood with seat and back-rest upholstered in leather with special stitching.*  
Total dimensions (W) 52, (D) 50, (H) 99 cm

## CVG002B

Sedia in ciliegio con sedile e schienale imbottito in bianco o tessuto/pelle cliente con particolari cuciture. TESSUTO OCCORRENTE PER L'IMBOTTITURA MT.2 IN H.MT 1,40 , PELLE 2,5 MQ. Dimensioni totali L 52 x P 50 x H 99 cm

*Chair in cherry wood with seat and back-rest upholstered in white or customer's fabric/leather with special stitching.*  
FABRIC NEEDED FOR THE UPHOLSTERING 2 MT, H Mt 1,40 , LEATHER 2,5 SQ.M.  
Total dimensions (W) 52, (D) 50, (H) 99 cm



## CVG003T

Sedia in ciliegio con sedile asportabile imbottito in tessuto.  
Dimensioni totali  
L 48 x P 44 x H 90 cm

*Chair in cherry wood with removable seat upholstered in white lining fabric.  
Total dimensions  
(W) 48, (D) 44, (H) 90 cm*

## CVG003P

Sedia in ciliegio con sedile asportabile imbottito in pelle.  
Dimensioni totali  
L 48 x P 44 x H 90 cm

*Chair in cherry wood with removable seat upholstered in leather. Total dimensions  
(W) 48, (D) 44, (H) 90 cm*

## CVG003B

Sedia in ciliegio con sedile asportabile imbottito in bianco o tessuto/pelle cliente.  
TESSUTO OCCORRENTE PER L'IMBOTTITURA  
MT 0,7 IN H. MT1,40 , PELLE 0,8 MQ.  
Dimensioni totali L 48 x P 44 x H 90 cm

*Chair in cherry wood with removable seat upholstered in white or customer's fabric/leather. FABRIC NEEDED FOR THE UPHOLSTERING 0.7 MT, H MT 1,40, LEATHER 0.8 SQ M.  
Total dimensions (W) 48, (D) 44, (H) 90 cm*





## CVH003T

Capotavola in ciliegio con sedile imbottito (asportabile) in tessuto.  
Dimensioni totali  
L 55 x P 45 x H 90 cm

*Head table chair in cherry with removable upholstery on the seat in fabric.*  
Total dimensions  
(W) 55, (D) 45, (H) 90 cm

## CVH003P

Capotavola in ciliegio con sedile imbottito (asportabile) in pelle.  
Dimensioni totali  
L 55 x P 45 x H 90 cm

*Head table chair in cherry with removable upholstery on the seat in leather.*  
Total dimensions  
(W) 55, (D) 45, (H) 90 cm

## CVH003B

Capotavola in ciliegio con sedile imbottito (asportabile) in bianco o tessuto/pelle cliente. TESSUTO OCCORRENTE PER L'IMBOTTITURA MT 0,80 IN H. MT 1,40, PELLE 0,80 MQ. Dimensioni totali L 55 x P 45 x H 90 cm

*Head table chair in cherry with removable upholstery on the seat in white lining fabric/leather or customer's fabric.*  
FABRIC NEEDED FOR THE UPHOLSTERING 0.80 MT., H. MT 1,40, LEATHER 0.80 SQ.M.  
Total dimensions (W) 55, (D) 45, (H) 90 cm

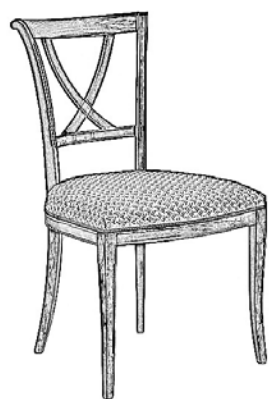

## CVG005T

Sedia in ciliegio con sedile imbottito in tessuto.  
Dimensioni totali  
L 50 x P 48 x H 94 cm

*Chair in cherry wood with seat upholstered in fabric.  
Total dimensions  
(W) 50, (D) 48, (H) 94 cm*

## CVG005P

Sedia in ciliegio con sedile imbottito in pelle.  
Dimensioni totali  
L 50 x P 48 x H 94 cm

*Chair in cherry wood with seat upholstered in leather.  
Total dimensions  
(W) 50, (D) 48, (H) 94 cm*

## CVG005B

Sedia in ciliegio con sedile imbottito in bianco o tessuto/pelle cliente. TESSUTO OCCORRENTE PER L'IMBOTTITURA MT 0,7 IN H MT 1,40, PELLE 0,8 MQ.  
Dimensioni totali L 50 x P 48 x H 94 cm

*Chair in cherry wood with seat upholstered in white or customer's fabric/leather.  
FABRIC NEEDED FOR THE UPHOLSTERING  
0.7 MT H MT 1,40, LEATHER 0.8 SQ M.  
Total dimensions (W) 50, (D) 48, (H) 94 cm*



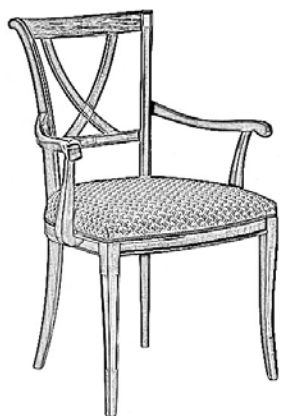

## CVH005T

Capotavola in ciliegio con sedile imbottito in tessuto.

Dimensioni totali  
L 54 x P 50 x H 94 cm

*Head table chair in cherry with upholstered seat in fabric. Total dimensions (W) 54, (D) 50, (H) 94 cm*

## CVH005P

Capotavola in ciliegio con sedile imbottito in pelle.

Dimensioni totali  
L 54 x P 50 x H 94 cm

*Head table chair in cherry with upholstered seat in leather. Total dimensions (W) 54, (D) 50, (H) 94 cm*

## CVH005B

Capotavola in ciliegio con sedile imbottito in bianco o tessuto/pelle cliente. TESSUTO OCCORRENTE PER L'IMBOTTITURA MT 0,80 IN H. MT 1,40, PELLE 0,80 MQ.

Dimensioni totali L 54 x P 50 x H 94 cm

*Head table chair in cherry with upholstered seat in white or customer's fabric/leather. FABRIC NEEDED FOR THE UPHOLSTERING 0.80 MT., H.MT 1,40, LEATHER 0.80 SQ.M. Total dimensions (W) 54, (D) 50, (H) 94 cm*

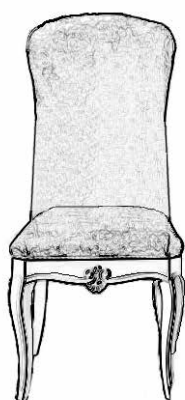

## CVG006T

Sedia in ciliegio con sedile e schienale imbottito in tessuto con particolare intagliato a mano.  
Dimensioni totali  
L 51 x P 60 x H 111 cm

*Chair in cherry wood with seat and back-rest upholstered in fabric with details hand cut.  
Total dimensions  
(W) 51, (D) 60, (H) 111 cm*

## CVG006P

Sedia in ciliegio con sedile e schienale imbottito in pelle con particolare intagliato a mano.  
Dimensioni totali  
L 51 x P 60 x H 111 cm

*Chair in cherry wood with seat and back-rest upholstered in leather with details hand cut.  
Total dimensions  
(W) 51, (D) 60, (H) 111 cm*

## CVG006B

Sedia in ciliegio con sedile e schienale imbottito in bianco o tessuto/pelle cliente con particolare intagliato a mano. TESSUTO OCCORRENTE PER L'IMBOTTITURA MT 1,50 IN H MT 1,40, PELLE 2,5 MQ.  
Dimensioni totali L 51 x P 60 x H 111 cm

*Chair in cherry wood with seat and back-rest upholstered in fabric with details hand cut. FABRIC NEEDED FOR THE UPHOLSTERING 1.50 MT H MT 1,40, LEATHER 2,5 SQ M.  
Total dimensions (W) 51, (D) 60, (H) 111 cm*





## CVG007T

Sedia in ciliegio con sedile imbottito in tessuto.  
Dimensioni totali  
L 48 x P 45 x H 96 cm

*Chair in cherry with seat upholstered in fabric.  
Total dimensions  
(W) 48, (D) 45, (H) 96 cm*

## CVG007P

Sedia in ciliegio con sedile imbottito in pelle.  
Dimensioni totali  
L 48 x P 45 x H 96 cm

*Chair in cherry with seat upholstered in leather.  
Total dimensions  
(W) 48, (D) 45, (H) 96 cm*

## CVG007B

Sedia in ciliegio con sedile imbottito in bianco o tessuto/pelle cliente. TESSUTO OCCORRENTE PER L'IMBOTTITURA MT.0,7 IN H. MT 1,40 , PELLE 0,8 MQ.  
Dimensioni totali L 48 x P 45 x H 96 cm

*Chair in cherry wood with seat upholstered in white or customer's fabric/leather.  
FABRIC NEEDED FOR THE UPHOLSTERING  
0.7 MT. H. MT 1,40 CM , LEATHER 0.8 SQ.M.  
Total dimensions (W) 48, (D) 45, (H) 96 cm*

## CVG009T

Sedia in ciliegio con sedile imbottito in tessuto e schienale canettato 2 lati. Dimensioni totali L 51 x P 66 x H 102 cm

*Chair in cherry with seat upholstered in fabric and back-rest in woven cane on 2 sides. Total dimensions (W) 51, (D) 66, (H) 102 cm*

## CVG009P

Sedia in ciliegio con sedile imbottito in pelle e schienale canettato 2 lati. Dimensioni totali L 51 x P 66 x H 102 cm

*Chair in cherry wood with seat upholstered in leather and back-rest in woven cane on 2 sides. Total dimensions (W) 51, (D) 66, (H) 102 cm*

## CVG009B

Sedia in ciliegio con sedile imbottito in bianco o tessuto/pelle cliente e schienale canettato 2 lati. TESSUTO OCCORRENTE PER L'IMBOTTITURA MT 0,7 IN H 140, PELLE 0,8 MQ  
Dimensioni totali L 51 x P 66 x H 102 cm

*Chair in cherry wood with seat upholstered in white or customer's fabric/leather and back-rest in woven cane on 2 sides. FABRIC NEEDED FOR THE UPHOLSTERING 0.7 MT. H.MT 1,40, LEATHER 0.8 SQ.M. Total dimensions (W) 51, (D) 66, (H) 102 cm*

## CVG008T

Sedia in ciliegio con sedile e schienale imbottito 2 lati in tessuto. Dimensioni totali L 51 x P 66 x H 102 cm

*Chair in cherry wood with seat and back-rest upholstered 2 sides in fabric. Total dimensions (W) 51, (D) 66, (H) 102 cm*

## CVG008P

Sedia in ciliegio con sedile e schienale imbottito 2 lati in pelle. Dimensioni totali L 51 x P 66 x H 102 cm

*Chair in cherry wood with seat and back-rest upholstered 2 sides in leather. Total dimensions (W) 51, (D) 66, (H) 102 cm*

## CVG008B

Sedia in ciliegio con sedile e schienale imbottito 2 lati in bianco o tessuto cliente. TESSUTO OCCORRENTE PER L'IMBOTTITURA MT 1,40 IN H MT 1,40, PELLE 2 MQ Dimensioni totali L 51 x P 66 x H 102 cm

*Chair in cherry wood with seat and back-rest upholstered 2 sides in white lining fabric or customer's fabric. FABRIC NEEDED FOR THE UPHOLSTERING 1.40 MT H MT 1,40, LEATHER 2 SQ M Total dimensions (W) 51, (D) 66, (H) 102 cm*

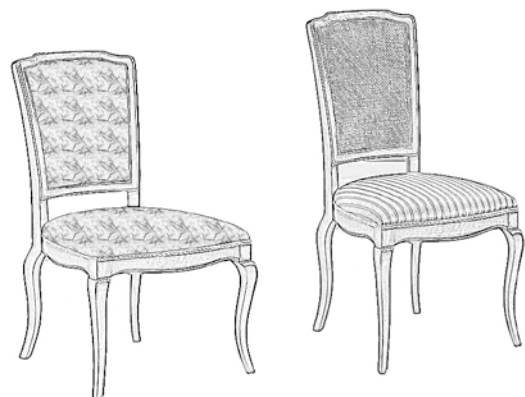

## CVH009T

Poltrona con sedile imbottito in tessuto e schienale canettato 2 lati. Dimensioni totali L 60 x P 66 x H 102 cm

*Armchair with seat upholstered in fabric and back-rest in woven cane on 2 sides. Total dimensions (W) 60, (D) 66, (H) 102 cm*

## CVH009P

Poltrona in ciliegio con sedile imbottito in pelle e schienale canettato 2 lati. Dimensioni totali L 60 x P 66 x H 102 cm

*Armchair in cherry wood with seat upholstered in leather and back-rest in woven cane on 2 sides. Total dimensions (W) 60, (D) 66, (H) 102 cm*

## CVH009B

Poltrona in ciliegio con sedile imbottito in bianco o tessuto/pelle cliente e schienale canettato 2 lati. TESSUTO OCCORRENTE PER L'IMBOTTITURA MT 0,8 IN H MT 1,40, PELLE 1,0 MQ  
Dimensioni totali L 60 x P 66 x H 102 cm

*Armchair in cherry wood with seat upholstered in white or customer's fabric/leather and back-rest in woven cane on 2 sides. FABRIC NEEDED FOR THE UPHOLSTERING 0.8 MT. H. MT 1,40, LEATHER 1.0 SQ.M. Total dimensions (W) 60, (D) 66, (H) 102 cm*

## CVH008T

Poltrona in ciliegio con sedile e schienale imbottito 2 lati in tessuto. Dimensioni totali L 60 x P 66 x H 102 cm

*Armchair in cherry wood with seat and back-rest upholstered 2 sides in fabric. Total dimensions (W) 60, (D) 66, (H) 102 cm*

## CVH008P

Poltrona in ciliegio con sedile e schienale imbottito 2 lati in pelle. Dimensioni totali L 60 x P 66 x H 102 cm

*Armchair in cherry wood with seat and back-rest upholstered 2 sides in leather. Total dimensions (W) 60, (D) 66, (H) 102 cm*

## CVH008B

Poltrona in ciliegio con sedile e schienale imbottito 2 lati in bianco o tessuto/pelle cliente. TESSUTO OCCORRENTE PER L'IMBOTTITURA MT 1,4 IN H MT 1,40, PELLE 2 MQ Dimensioni totali L 60 x P 66 x H 102 cm

*Armchair in cherry wood with seat and back-rest upholstered 2 sides in white lining fabric or customer's fabric/leather. FABRIC NEEDED FOR THE UPHOLSTERING 1.4 MT H MT 1,40, LEATHER 2 SQ M Total dimensions (W) 60, (D) 66, (H) 102 cm*

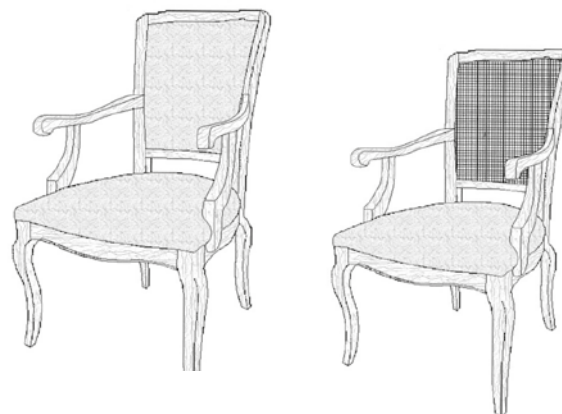





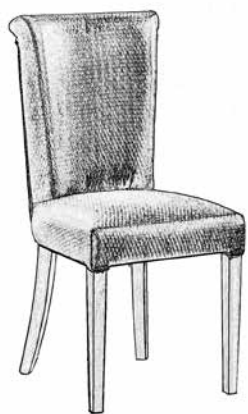

## CVG010T

Sedia in ciliegio imbottita in tessuto sfoderabile.  
Dimensioni totali  
L 47 x P 57 x H 98 cm

*Chair in cherry wood with  
removable upholstery in fabric.  
Total dimensions  
(W) 47, (D) 57, (H) 98 cm*

## CVG010B

Sedia in ciliegio imbottita in bianco o tessuto cliente sfoderabile.  
TESSUTO OCCORRENTE PER L'IMBOTTITURA  
MT 1,8 IN H MT 1,40 , PELLE 2,50 MQ.  
Dimensioni totali L 47 x P 57 x H 98 cm

*Chair in cherry with removable upholstery  
in white lining fabric or customer's fabric.  
FABRIC NEEDED FOR THE UPHOLSTERING  
1,8 MT H MT 1.40, LEATHER 2.50 SQ M.  
Total dimensions (W) 47, (D) 57, (H) 98 cm*



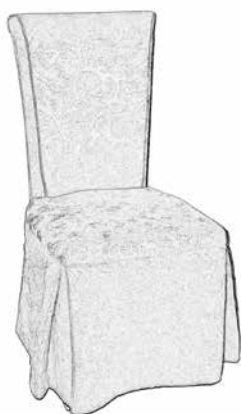

## CVG011T

Sedia in faggio imbottita in tessuto sfoderabile.  
Dimensioni totali L 47 x P 57 x H 98 cm

*Chair in beech with removable upholstery in fabric.  
Total dimensions (W) 47 x (D) 57 x (H) 98cm*

## CVG011B

Sedia in faggio imbottita in tessuto sfoderabile. TESSUTO OCCORRENTE PER L'IMBOTTITURA MT 3,50 IN H MT 1,40, PELLE 4,5 MQ  
Dimensioni totali L 47 x P 57 x H 98 cm

*Chair in beech with removable upholstery in fabric. FABRIC REQUIRED FOR UPHOLSTERING MT 3.5 H MT 1.40 / LEATHER 4.5 SQ.  
Total dimensions (W) 47 x (D) 57 x (H) 98cm*



## CVG012T

Sedia in ciliegio con sedile e schienale imbottiti in tessuto.  
Dimensioni totali  
L 51 x P 57 x H 93 cm

*Chair in cherry wood with seat and back upholstered in fabric.  
Total dimensions  
(W) 51 x (D) 57 x (H) 93cm*

## CVG012P

Sedia in ciliegio con sedile e schienale imbottiti in pelle.  
Dimensioni totali  
L 51 x P 57 x H 93 cm

*Chair in cherry wood with seat and back upholstered in leather.  
Total dimensions  
(W) 51 x (D) 57 x (H) 93cm*

## CVG012B

Sedia in ciliegio con sedile e schienale imbottiti in bianco o in tessuto/pelle cliente.  
TESSUTO OCCORRENTE PER L'IMBOTTITURA  
MT 1,40 IN H MT 1,40, PELLE 2 MQ  
Dimensioni totali L 51 x P 57 x H 93 cm

*Chair in cherry wood with seat and back upholstered in white or customer's fabric/leather. FABRIC REQUIRED FOR UPHOLSTERING  
MT 1.4 H MT 1.40 / LEATHER 2 SQ.  
Total dimensions (W) 51 x (D) 57 x (H) 93cm*





## CVG023T

Sedia in faggio con sedile imbottito in tessuto.  
Dimensioni totali  
L 48 x P 50 x H 89 cm

*Chair in beech with seat upholstered in fabric.  
Total dimensions  
(W) 48 x (D) 50 x (H) 89cm*

## CVG023P

Sedia in faggio con sedile imbottito in pelle.  
Dimensioni totali  
L 48 x P 50 x H 89 cm

*Chair in beech with seat upholstered in leather.  
Total dimensions  
(W) 48 x (D) 50 x (H) 89cm*

## CVG023B

Sedia in faggio con sedile imbottito in bianco o in tessuto/pelle cliente.  
TESSUTO OCCORRENTE PER L'IMBOTTITURA  
MT 0,60 IN H MT 1,40, PELLE 0,80 MQ  
Dimensioni totali L 48 x P 50 x H 89 cm

*Chair in beech with seat upholstered in white or customer's fabric/leather.  
FABRIC REQUIRED FOR UPHOLSTERING MT  
0,6 H MT 1,40 / LEATHER 0,8 SQ.  
Total dimensions (W) 48 x (D) 50 x (H) 89cm*

## CVG016T

Sedia in faggio con sedile e schienale imbottiti in tessuto.  
Dimensioni totali L 50 x P 45 x H 97 cm

*Chair in beech wood with seat and back upholstered in fabric.  
Total dimensions (W) 50 x (D) 45 x (H) 97cm*

## CVG016P

Sedia in faggio con sedile e schienale imbottiti in pelle.  
Dimensioni totali L 50 x P 45 x H 97 cm

*Chair in beech wood with seat and back upholstered in leather.  
Total dimensions (W) 50 x (D) 45 x (H) 97cm*

## CVG016B

Sedia in faggio con sedile e schienale imbottiti in bianco o pelle/tessuto cliente.  
TESSUTO OCCORRENTE PER L'IMBOTTITURA MT 1,30 IN H MT 1,40, PELLE 1,5 MQ  
Dimensioni totali L 50 x P 45 x H 97 cm

*Chair in beech wood with seat and back upholstered in white or customer's leather/fabric.  
FABRIC REQUIRED FOR UPHOLSTERING MT 1.3 H MT 1.40 / LEATHER 1,5 SQ.  
Total dimensions (W) 50 x (D) 45 x (H) 97cm*



## CVG017T

Sedia in faggio con schienale canaletto e sedile imbottito in tessuto.  
Dimensioni totali L 50 x P 45 x H 97 cm

*Chair in beech wood with grosgrain back and upholstered seat in fabric.  
Total dimensions (W) 50 x (D) 45 x (H) 97cm*

## CVG017P

Sedia in faggio con schienale canaletto e sedile imbottito in pelle.  
Dimensioni totali L 50 x P 45 x H 97 cm

*Chair in beech wood with grosgrain back and upholstered seat in leather.  
Total dimensions (W) 50 x (D) 45 x (H) 97cm*

## CVG017B

Sedia in faggio con schienale canaletto e sedile imbottito in bianco o con tessuto/pelle cliente.  
TESSUTO OCCORRENTE PER L'IMBOTTITURA MT 0,60 IN H MT 1,40, PELLE 0,7 MQ  
Dimensioni totali L 50 x P 45 x H 97 cm

*Chair in beech wood with grosgrain back and upholstered seat in white or customer fabric/leather.  
FABRIC REQUIRED FOR UPHOLSTERING MT 0.6 H MT 1.40 / LEATHER 0.7 SQ.  
Total dimensions (W) 50 x (D) 45 x (H) 97cm*







## CVG019T

Sedia in ciliegio con sedile e schienale imbottito in tessuto.  
Dimensioni totali L 57 x P 57 x H 120 cm

*Chair in cherry wood with fabric upholstered seat and back.  
Total dimensions (W) 57 x (D) 57 x (H) 120cm*

## CVG019P

Sedia in ciliegio con sedile e schienale imbottito in pelle.  
Dimensioni totali L 57 x P 57 x H 120 cm

*Chair in cherry wood with seat and back upholstered in leather.  
Total dimensions (W) 57 x (D) 57 x (H) 120cm*

## CVG019B

Sedia in ciliegio con sedile e schienale imbottito in pelle/tessuto cliente.  
TESSUTO OCCORRENTE PER L'IMBOTTITURA MT 1,60 IN H MT 1,40, PELLE 2 MQ  
Dimensioni totali L 57 x P 57 x H 120 cm

*Chair in cherry wood with fabric upholstered seat and back.  
FABRIC REQUIRED FOR UPHOLSTERING MT 1.6 H MT 1.40 / LEATHER 2 SQ.  
Total dimensions (W) 57 x (D) 57 x (H) 120cm*

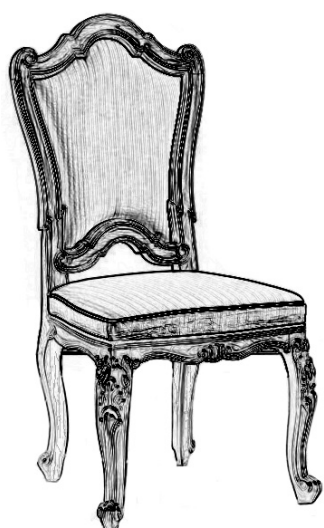







## CVG020T

Sedia in ciliegio con sedile e schienale imbottiti in tessuto.  
Dimensioni totali  
L 46 x P 58 x H 100 cm

*Chair in cherry wood with seat and back upholstered in fabric.  
Total dimensions  
(W) 46 x (D) 58 x (H) 100cm*

## CVG020P

Sedia in ciliegio con sedile e schienale imbottiti in pelle.  
Dimensioni totali  
L 46 x P 58 x H 100 cm

*Chair in cherry wood with seat and back upholstered in leather.  
Total dimensions  
(W) 46 x (D) 58 x (H) 100cm*

## CVG020B

Sedia in ciliegio con sedile e schienale imbottiti in bianco o tessuto/pelle cliente.  
TESSUTO OCCORRENTE PER L'IMBOTTITURA  
MT 1,40 IN H MT 1,40, PELLE 1,8 MQ  
Dimensioni totali L 46 x P 58 x H 100 cm

*Walnut chair upholstered in white or customer's fabric/leather. FABRIC  
REQUIRED FOR UPHOLSTERING MT 1.4 H MT  
1.40 / LEATHER 1,8 SQ. Total dimensions  
(W) 46 x (D) 58 x (H) 100cm*





## CVH020T

Capotavola in ciliegio con sedile e schienale imbottiti in tessuto.  
Dimensioni totali  
L 59 x P 65 x H 100 cm

*Head table chair in cherry wood with seat and back upholstered in fabric. Total dimensions (W) 59 x (D) 65 x (H) 100cm*

## CVH020P

Capotavola in ciliegio con sedile e schienale imbottiti in pelle.  
Dimensioni totali  
L 59 x P 65 x H 100 cm

*Head table chair in cherry wood with seat and back upholstered in leather. Total dimensions (W) 59 x (D) 65 x (H) 100cm*

## CVH020B

Capotavola in ciliegio con sedile e schienale imbottiti in bianco o tessuto/pelle cliente. TESSUTO OCCORRENTE PER L'IMBOTTITURA MT 1,40 IN H MT 1,40, PELLE 2 MQ Dimensioni totali L 59 x P 65 x H 100 cm

*Walnut chair upholstered in white or customer's fabric. FABRIC REQUIRED FOR UPHOLSTERING MT 1.4 H MT 1.40 / LEATHER 2 SQ. Total dimensions (W) 59 x (D) 65 x (H) 100cm*



## CVG024T

Sedia in faggio tutta imbottita in tessuto. Retro schiena in capitonné. Dimensioni totali L 50 x P 53 x H 106 cm

*Chair in beech upholstered in fabric with upholstered back in capitonné. Total dimensions (W) 50 x (D) 53 x (H) 106cm*

## CVG024P

Sedia in faggio tutta imbottita in pelle. Retro schiena in capitonné. Dimensioni totali L 50 x P 53 x H 106 cm

*Chair in beech upholstered in leather with upholstered back in capitonné. Total dimensions (W) 50 x (D) 53 x (H) 106cm*

## CVG024B

Sedia in faggio tutta imbottita in bianco o in tessuto/pelle cliente. Retro schiena in capitonné. TESSUTO OCCORRENTE PER L'IMBOTTITURA MT 1,70 IN H 1,40, PELLE 2,50 MQ  
Dimensioni totali L 50 x P 53 x H 106 cm

*Chair in beech upholstered in white or customer's fabric with upholstered back in capitonné. FABRIC REQUIRED FOR UPHOLSTERING MT 1.7 H MT 1.40 / LEATHER 2.5 SQ.  
Total dimensions (W) 50 x (D) 53 x (H) 106cm*





## CVG030T

Sedia in faggio tutta imbottita in tessuto. Dimensioni totali L 61 x P 62 x H 100 cm

*Chair in beech upholstered in fabric.  
Total dimensions  
(W) 61 x (D) 62 x (H) 100cm*

## CVG030P

Sedia in faggio tutta imbottita in pelle. Dimensioni totali L 61 x P 62 x H 100 cm

*Chair in beech upholstered in leather.  
Total dimensions  
(W) 61 x (D) 62 x (H) 100cm*

## CVG030B

Sedia in faggio tutta imbottita in bianco o in tessuto/pelle cliente. TESSUTO OCCORRENTE PER L'IMBOTTITURA MT 1,80 IN H MT 1,40, PELLE 2,5 MQ  
Dimensioni totali L 61 x P 62 x H 100 cm

*Chair in beech upholstered in white or customer's fabric/leather.  
FABRIC REQUIRED FOR UPHOLSTERING MT 1.8 H MT 1.40 / LEATHER 2.5 SQ.  
Total dimensions (W) 61 x (D) 62 x (H) 100cm*

## CVG031T

Sedia in noce con sedile e schienale imbottiti in tessuto.  
Dimensioni totali L 48 x P 53 x H 90 cm

*Walnut chair upholstered in fabric.  
Total dimensions (W) 48 x (D) 53 x (H) 90cm*

## CVG031P

Sedia in noce con sedile e schienale imbottiti in pelle.  
Dimensioni totali L 48 x P 53 x H 90 cm

*Walnut chair upholstered in leather.  
Total dimensions (W) 48 x (D) 53 x (H) 90cm*

## CVG031B

Sedia in noce con sedile e schienale imbottiti bianco o in tessuto/pelle cliente.  
TESSUTO OCCORRENTE PER L'IMBOTTITURA MT 1,20 IN H 1,40, PELLE 1,8 MQ  
Dimensioni totali L 48 x P 53 x H 90 cm

*Walnut chair upholstered in white or customer's fabric/leather.  
FABRIC REQUIRED FOR UPHOLSTERING MT 1.2 H MT 1.40 / LEATHER 1,8 SQ.  
Total dimensions (W) 48 x (D) 53 x (H) 90cm*









## CVG004

Sedia in ciliegio con sedile e schienale canettato.  
Dimensioni totali L 51 x P 44 x H 93 cm

*Chair in cherry wood with seat and back rest in woven cane.  
Total dimensions (W) 51, (D) 44, (H) 93 cm*





## CVH004

Capotavola in ciliegio con sedile e schienale canettati.  
Dimensioni totali L 58 x P 48 x H 97 cm

*Head table chair in cherry wood with grosgrain seat and back.  
Total dimensions (W) 58 x (D) 48 x (H) 97cm*

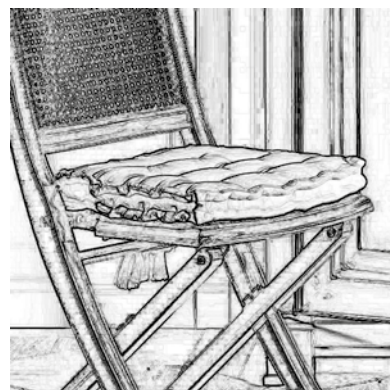

## SFC016

Sedia in ciliegio pieghevole  
misure ripiegata (39 x 16 x 88).  
Dimensioni totali  
L 39 x P 46 x H 88 cm

*Foldable chair in cherry  
measurements when folded (39 x  
16 x 88cm). Total dimensions  
(W) 39, (D) 46, (H) 88 cm*

## ACZ008

Cuscinetto trapuntato sfoderabile per  
sedia SFC016. Dimensioni totali  
L 39 x P 40 x H 5 cm

*Small cushion with removable quilted  
cushion cover for chair SFC016.  
Total dimensions (W) 39, (D) 40, (H) 5 cm*





## CVH022T

Poltrona in ciliegio imbottita in tessuto. Dimensioni totali L 56 x P 50 x H 87 cm

*Armchair in cherry wood upholstered in fabric. Total dimensions (W) 56 x (D) 50 x (H) 87cm*

## CVH022P

Poltrona in ciliegio imbottita in pelle. Dimensioni totali L 56 x P 50 x H 87 cm

*Armchair in cherry wood upholstered in leather. Total dimensions (W) 56 x (D) 50 x (H) 87cm*

## CVH022B

Poltrona in ciliegio imbottita in bianco o tessuto/pelle cliente. TESSUTO OCCORRENTE PER L'IMBOTTITURA MT 1,40 IN H MT 1,40, PELLE 1,7 MQ Dimensioni totali L 56 x P 50 x H 87 cm

*Armchair in cherry wood upholstered in white or customer's fabric/leather. FABRIC REQUIRED FOR UPHOLSTERING MT 1.4 H MT 1.40 / LEATHER 1.7 SQ. Total dimensions (W) 56 x (D) 50 x (H) 87cm*

## CVG032

Sedia in faggio.  
Dimensioni totali L 50 x P 50 x H 90 cm

*Oak chair.*  
*Total dimensions (W) 50 x (D) 50 x (H) 90cm*



## CVG035T

Sgabello in faggio con sedile imbottito in tessuto.  
Dimensioni totali L 50 x P 50 x H 90 cm seduta H 65 cm

*Stool in oak with seat upholstered in fabric.*  
*Total dimensions (W) 50 x (D) 50 x (H) 90cm seat (H) 65cm*



## CVG035P

Sgabello in faggio con sedile imbottito in pelle.  
Dimensioni totali L 50 x P 50 x H 90 cm seduta H 65 cm

*Stool in oak with seat upholstered in leather.*  
*Total dimensions (W) 50 x (D) 50 x (H) 90cm seat (H) 65cm*

## CVG035B

Sgabello in faggio con sedile imbottito in bianco o tessuto/pelle cliente.  
TESSUTO OCCORRENTE PER L'IMBOTTITURA MT 0,60 IN H MT 1,40, PELLE 0,60 MQ  
Dimensioni totali L 50 x P 50 x H 90 cm seduta H 65 cm

*Stool in beech wood with seat upholstered in white or customer fabric/leather.*  
*FABRIC REQUIRED FOR UPHOLSTERING MT 0.6 H MT 1.40 / LEATHER 0.6 SQ.*  
*Total dimensions (W) 50 x (D) 50 x (H) 90cm seat (H) 65cm*





## CVG025T

Sgabello in faggio con sedile e schienale imbottiti in tessuto.  
Dimensioni totali L 46 x P 45 x H 112 cm seduta H 68 cm.

*Stool in beech with seat and back upholstered in fabric.  
Total dimensions (W) 46 x (D) 45 x (H) 112cm seat H 68cm*

## CVG025P

Sgabello in faggio con sedile e schienale imbottiti in pelle.  
Dimensioni totali L 46 x P 45 x H 112 cm seduta H 68 cm.

*Stool in beech with seat and back upholstered in leather.  
Total dimensions (W) 46 x (D) 45 x (H) 112cm seat H 68cm*

## CVG025B

Sgabello in faggio con sedile e schienale imbottiti in bianco o tessuto/pelle cliente.  
TESSUTO OCCORRENTE PER L'IMBOTTITURA MT 1,00 IN H MT 1,40, PELLE 1,5 MQ  
Dimensioni totali L 46 x P 45 x H 112 cm seduta H 68 cm.

*Stool in beech with seat and back upholstered in white or customer's fabric/leather.  
FABRIC REQUIRED FOR UPHOLSTERING MT 1.0 H MT 1.40 / LEATHER 1.5 SQ.  
Total dimensions (W) 46 x (D) 45 x (H) 112cm seat H 68cm*



## CVG026T

Sgabello in faggio con sedile e schienale imbottiti in tessuto.  
Dimensioni totali L 46 x P 45 x H 122 cm seduta H 78 cm

*Stool in beech with seat and back upholstered in fabric.  
Total dimensions (W) 46 x (D) 45 x (H) 122cm seat (H) 78cm*

## CVG026P

Sgabello in faggio con sedile e schienale imbottiti in pelle.  
Dimensioni totali L 46 x P 45 x H 122 cm seduta H 78 cm

*Stool in beech with seat and back upholstered in leather.  
Total dimensions (W) 46 x (D) 45 x (H) 122cm seat (H) 78cm*

## CVG026B

Sgabello in faggio con sedile e schienale imbottiti in bianco o tessuto/pelle cliente.  
TESSUTO OCCORRENTE PER L'IMBOTTITURA MT 1,00 IN H MT 1,40, PELLE 1,5 MQ  
Dimensioni totali L 46 x P 45 x H 122 cm seduta H 78 cm

*Stool in beech with seat and back upholstered in white or customer's fabric/leather.  
FABRIC REQUIRED FOR UPHOLSTERING MT 1.0 H MT 1.40 / LEATHER 1.5 SQ.  
Total dimensions (W) 46 x (D) 45 x (H) 122cm seat (H) 78cm*









## CVG027T

Sgabello in faggio con sedile e schienale imbottiti in tessuto.  
Dimensioni totali  
L 49 x P 60 x H 119 cm  
seduta H 81 cm

*Stool in beech with seat and back upholstered in fabric.  
Total dimensions  
(W) 49 x (D) 60 x (H) 119cm  
seat H 81cm*

## CVG027P

Sgabello in faggio con sedile e schienale imbottiti in pelle.  
Dimensioni totali  
L 49 x P 60 x H 119 cm  
seduta H 81 cm

*Stool in beech with seat and back upholstered in leather.  
Total dimensions  
(W) 49 x (D) 60 x (H) 119cm  
seat H 81cm*

## CVG027B

Sgabello in faggio con sedile e schienale imbottiti in bianco o tessuto/pelle cliente.  
TESSUTO OCCORRENTE PER L'IMBOTTITURA  
MT 1,20 IN H MT 1,40, PELLE 1,50 MQ  
Dimensioni totali L 49 x P 60 x H 119 cm  
seduta H 81 cm

*Walnut chair upholstered in white or customer's fabric/leather. FABRIC REQUIRED FOR UPHOLSTERING MT 1.2 H MT 1.40 / LEATHER 1.5 SQ. Total dimensions (W) 49 x (D) 60 x (H) 119cm seat H 81cm*





## CVG029T

Sgabello in faggio con sedile e schienale imbottiti in tessuto.  
 Dimensioni totali  
 L 47 x P 52 x H 104 cm  
 seduta H 73 cm

*Stool in beech with seat and back upholstered in fabric.  
 Total dimensions  
 (W) 47 x (D) 52 x (H) 104cm  
 seat H 73cm*

## CVG029P

Sgabello in faggio con sedile e schienale imbottiti in pelle.  
 Dimensioni totali  
 L 47 x P 52 x H 104 cm  
 seduta H 73 cm

*Stool in beech with seat and back upholstered in leather.  
 Total dimensions  
 (W) 47 x (D) 52 x (H) 104cm  
 seat H 73cm*

## CVG029B

Sgabello in faggio con sedile e schienale imbottiti in bianco o tessuto/pelle cliente.  
 TESSUTO OCCORRENTE PER L'IMBOTTITURA  
 MT 1,20 IN H MT 1,40, PELLE 1,5 MQ  
 Dimensioni totali  
 L 47 x P 52 x H 104 cm seduta H 73 cm

*Stool in beech with seat and back upholstered in white or customer's fabric/leather. FABRIC REQUIRED FOR UPHOLSTERING MT 1.2 H MT 1.40 / LEATHER 1.5 SQ. Total dimensions (W) 47 x (D) 52 x (H) 104cm seat H 73cm*

## CVG033T

Sgabello in faggio con sedile imbottito in tessuto.  
Dimensioni totali L 40 x P 40 x H 68 cm

*Stool in beech upholstered in fabric.  
Total dimensions (W) 40 x (D) 40 x (H) 68cm*

## CVG033P

Sgabello in faggio con sedile imbottito in pelle.  
Dimensioni totali L 40 x P 40 x H 68 cm

*Stool in beech upholstered in leather.  
Total dimensions (W) 40 x (D) 40 x (H) 68cm*

## CVG033B

Sgabello in faggio con sedile imbottito in bianco o tessuto/pelle cliente.  
TESSUTO OCCORRENTE PER L'IMBOTTITURA MT 0,60 IN H MT 1,40, PELLE 0,6 MQ  
Dimensioni totali L 40 x P 40 x H 68 cm

*Stool in beech with seat upholstered in white or customer's fabric/leather.  
FABRIC REQUIRED FOR UPHOLSTERING MT 0.6 H MT 1.40 / LEATHER 0.6 SQ.  
Total dimensions (W) 40 x (D) 40 x (H) 68cm*

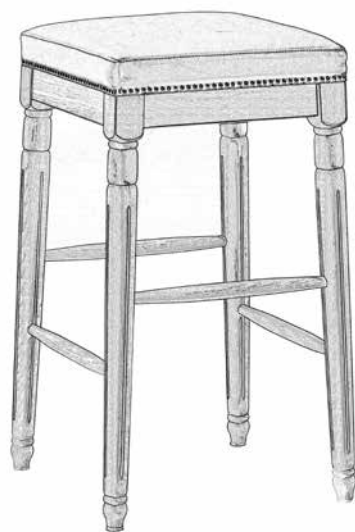





## CVG034T

Sgabello in faggio con sedile imbottito in tessuto.  
Dimensioni totali L 51 x P 51 x H 68 cm

*Stool in beech with seat upholstered in fabric.  
Total dimensions (W) 51 x (D) 51 x (H) 68cm*

## CVG034P

Sgabello in faggio con sedile imbottito in pelle.  
Dimensioni totali L 51 x P 51 x H 68 cm

*Stool in beech with seat upholstered in leather.  
Total dimensions (W) 51 x (D) 51 x (H) 68cm*

## CVG034B

Sgabello in faggio con sedile imbottito in bianco o tessuto/pelle cliente.  
TESSUTO OCCORRENTE PER L'IMBOTTITURA MT 0,8 IN H MT 1,40, PELLE 1 MQ  
Dimensioni totali L 51 x P 51 x H 68 cm

*Stool in beech with seat upholstered in white or customer's fabric/leather.  
FABRIC REQUIRED FOR UPHOLSTERING MT 0.8 H MT 1.40 / LEATHER 1 SQ.  
Total dimensions (W) 51 x (D) 51 x (H) 68cm*



## CVG036T

Sgabello in faggio con sedile imbottito in tessuto.  
Dimensioni totali L 41 x P 41 x H 51,5 cm

*Stool in beech with seat upholstered in fabric.  
Total dimensions (W) 41 x (D) 41 x (H) 51,5cm*

## CVG036P

Sgabello in faggio con sedile imbottito in pelle.  
Dimensioni totali L 41 x P 41 x H 51,5 cm

*Stool in beech with seat upholstered in leather.  
Total dimensions (W) 41 x (D) 41 x (H) 51,5cm*

## CVG036B

Sgabello in faggio con sedile imbottito in bianco o tessuto/pelle cliente.  
TESSUTO OCCORRENTE PER L'IMBOTTITURA MT 0,8 IN H MT 1,40, PELLE 1 MQ  
Dimensioni totali L 41 x P 41 x H 51,5 cm

*Stool in beech with seat upholstered in white or customer's fabric/leather.  
FABRIC REQUIRED FOR UPHOLSTERING MT 0.8 H MT 1.40 / LEATHER 1 SQ.  
Total dimensions (W) 41 x (D) 41 x (H) 51,5cm*















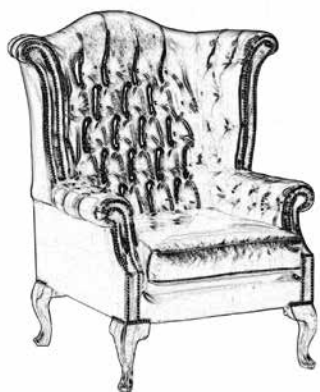

## CVH010T

Poltrona in tessuto con cuscino.  
Dimensioni totali  
L 100 x P 73 x H 110 cm

*Armchair in fabric with cushion.  
Total dimensions  
(W) 100, (D) 73, (H) 110 cm*

## CVH010P

Poltrona in pelle con cuscino.  
Dimensioni totali  
L 100 x P 73 x H 110 cm

*Armchair in leather with cushion.  
Total dimensions  
(W) 100, (D) 73, (H) 110 cm*

## CVH010B

Poltrona con tessuto/pelle cliente con  
cuscino. TESSUTO OCCORRENTE PER  
L'IMBOTTITURA MT. 5,5 IN H.MT 1,40, PELLE  
8,5 MQ.  
Dimensioni totali L 100 x P 73 x H 110 cm

*Armchair in client's fabric/leather with  
cushion. FABRIC NEEDED FOR THE  
UPHOLSTERING 5,5 MT. H. MT 1.40, LEATHER  
8.5 SQ.M.  
Total dimensions (W) 100, (D) 73, (H) 110 cm*





## CVH019T

Poltrona imbottita in tessuto come foto.  
Dimensioni totali L 85 x P 90 x H 100 cm

*Armchair upholstered fabric as shown in the picture.  
Total dimensions (W) 85 x (D) 90 x (H) 100cm*



## CVH017T

Poltrona imbottita in tessuto.  
Dimensioni totali  
L 79 x P 67 x H 103 cm

*Armchair upholstered in fabric.  
Total dimensions  
(W) 79 x (D) 67 x (H) 103cm*

## CVH017P

Poltrona imbottita in pelle.  
Dimensioni totali  
L 79 x P 67 x H 103 cm

*Armchair upholstered in leather.  
Total dimensions  
(W) 79 x (D) 67 x (H) 103cm*

## CVH017B

Poltrona imbottita in tessuto/pelle cliente.  
TESSUTO OCCORRENTE PER L'IMBOTTITURA  
MT 3,50 IN H MT 1,40, PELLE 4,50 MQ  
Dimensioni totali L 79 x P 67 x H 103 cm

*Armchair upholstered in customer's  
fabric/leather. FABRIC REQUIRED FOR  
UPHOLSTERING MT 3.5 H MT 1.40 / LEATHER  
4.5 SQ. Total dimensions  
(W) 79 x (D) 67 x (H) 103cm*





## CVH016T

Poltrona con prezioso intaglio su schienale imbottita in tessuto.  
Dimensioni totali  
L 90 x P 95 x H 108 cm

*Armchair with back carving,  
upholstered in fabric.  
Total dimensions  
(W) 90 x (D) 95 x (H) 108cm*

## CVH016P

Poltrona con prezioso intaglio su schienale imbottita in pelle.  
Dimensioni totali  
L 90 x P 95 x H 108 cm

*Armchair with back carving,  
upholstered in leather.  
Total dimensions  
(W) 90 x (D) 95 x (H) 108cm*

## CVH016B

Poltrona con prezioso intaglio su schienale, imbottita in tessuto/pelle cliente.  
TESSUTO OCCORRENTE PER L'IMBOTTITURA  
MT 4 IN H MT 1,40, PELLE 6,5 MQ  
Dimensioni totali  
L 90 x P 95 x H 108 cm

*Armchair with back carving, upholstered in  
customer's fabric/leather. FABRIC REQUIRED  
FOR UPHOLSTERING MT 4 H MT 1.40 /  
LEATHER 6.5 SQ. Total dimensions (W) 90 x  
(D) 95 x (H) 108cm*

## SFS015

Poltrona in ciliegio imbottita in tessuto.  
Dimensioni totali L 63 x P 80 x H 87 cm

*Cherry wood armchair upholstered in fabric.  
Total dimensions (W) 63 x (D) 80 x (H) 87cm*

## SFP015

Poltrona in ciliegio imbottita in pelle.  
Dimensioni totali L 63 x P 80 x H 87 cm

*Cherry wood armchair upholstered in leather.  
Total dimensions (W) 63 x (D) 80 x (H) 87cm*

## SFB015

Poltrona in ciliegio imbottita in tessuto/pelle cliente.  
TESSUTO OCCORRENTE PER L'IMBOTTITURA MT 4 IN H 1,40, PELLE 6 MQ  
Dimensioni totali L 63 x P 80 x H 87 cm

*Cherry wood armchair upholstered in customer's fabric/leather.  
FABRIC REQUIRED FOR UPHOLSTERING MT 4 H MT 1.40 / LEATHER 6 SQ.  
Total dimensions (W) 63 x (D) 80 x (H) 87cm*







## CVH021T

Poltrona imbottita in tessuto.  
Dimensioni totali L 74 x P 95 x H 115 cm

*Armchair upholstered in fabric.  
Total dimensions (W) 74 x (D) 95 x (H) 115cm*

## CVH021P

Poltrona imbottita in pelle.  
Dimensioni totali L 74 x P 95 x H 115 cm

*Armchair upholstered in leather.  
Total dimensions (W) 74 x (D) 95 x (H) 115cm*

## CVH021B

Poltrona imbottita in tessuto/pelle cliente.  
TESSUTO OCCORRENTE PER L'IMBOTTITURA MT 4 IN H MT 1,40, PELLE 6 MQ  
Dimensioni totali L 74 x P 95 x H 115 cm

*Armchair upholstered in customer's fabric/leather.  
FABRIC REQUIRED FOR UPHOLSTERING MT 4 H MT 1.40 / LEATHER 6 SQ.  
Dimensioni totali L 74 x P 95 x H 115 cm*



## CVE021T

Pouf imbottito in tessuto.  
Dimensioni totali L 73 x P 55 x H 50 cm

*Pouffe ottoman upholstered in fabric.  
Total dimensions (W) 73 x (D) 55 x (H) 50cm*

## CVE021P

Pouf imbottito in pelle.  
Dimensioni totali L 73 x P 55 x H 50 cm

*Pouffe ottoman upholstered in leather.  
Total dimensions (W) 73 x (D) 55 x (H) 50cm*

## CVE021B

Pouf imbottito in tessuto/pelle cliente.  
TESSUTO OCCORRENTE PER L'IMBOTTITURA MT 2 IN H MT 1,40, PELLE 3,5 MQ  
Dimensioni totali L 73 x P 55 x H 50 cm

*Pouffe ottoman upholstered in customer's fabric/leather.  
FABRIC REQUIRED FOR UPHOLSTERING MT 2 H MT 1.40 / LEATHER 3,5 SQ.  
Total dimensions (W) 73 x (D) 55 x (H) 50cm*









## CVH007T

Poltrona in ciliegio girevole con sedile e schienale imbottito in tessuto. Meccanismo regolabile alza/abbassa a gas. Dimensioni totali L 53 x P 53 x H 102 cm

*Swivel armchair in cherry with upholstered seat and back-rest in fabric. Height adjustment mechanism with gas. Total dimensions (W) 53, (D) 53, (H) 102 cm*

## CVH007P

Poltrona in ciliegio girevole con sedile e schienale imbottito in pelle. Meccanismo regolabile alza/abbassa a gas. Dimensioni totali L 53 x P 53 x H 102 cm

*Swivel armchair in cherry with upholstered seat and back-rest in leather. Height adjustment mechanism with gas. Total dimensions (W) 53, (D) 53, (H) 102 cm*

## CVH007B

Poltrona in ciliegio girevole con sedile e schienale imbottito in tessuto/pelle cliente. Meccanismo regolabile alza/abbassa a gas. TESSUTO OCCORRENTE PER L'IMBOTTITURA MT 1,30 IN H. MT 1,40 , PELLE 1,60 MQ. Dimensioni totali L 53 x P 53 x H 102 cm

*Swivel armchair in cherry with upholstered seat and back-rest in client's fabric/leather. Height adjustment mechanism with gas. FABRIC NEEDED FOR THE UPHOLSTERING 1,30 MT. H.140CM , LEATHER 1,60 SQ.M. Total dimensions (W) 53, (D) 53, (H) 102 cm*



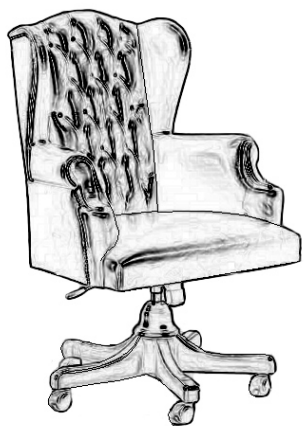

## CVH018P

Poltrona in pelle imbottita con meccanismo di sollevamento e orientabile.

Dimensioni totali  
L 70 x P 65 x H 111 cm

*Armchair upholstered in leather, with adjustable reclining mechanism.*

*Total dimensions  
(W) 70 x (D) 65 x (H) 111cm*

## CVH018B

Poltrona imbottita in pelle cliente con meccanismo di sollevamento e orientabile.  
TESSUTO OCCORRENTE PELLE 8 MQ

Dimensioni totali  
L 70 x P 65 x H 111 cm

*Armchair upholstered in customer's leather, with adjustable reclining mechanism.*

*LEATHER REQUIRED 8 SQ.  
Total dimensions (W) 70 x (D) 65 x (H) 111cm*

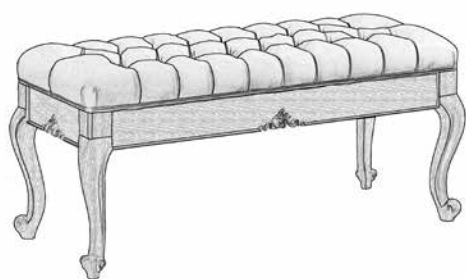

## CVE011T

Panchetta in faggio imbottita in tessuto capitonné con traverso intagliato a mano.  
Dimensioni totali  
L 130 x P 50 x H 50 cm

*Small bench in beech upholstered in fabric, with upper beam inlaid by hand.*  
Total dimensions  
(W) 130 x (D) 50 x (H) 50cm

## CVE011P

Panchetta in faggio imbottita in pelle capitonné con traverso intagliato a mano.  
Dimensioni totali  
L 130 x P 50 x H 50 cm

*Small bench in beech upholstered in leather, with upper beam inlaid by hand.*  
Total dimensions  
(W) 130 x (D) 50 x (H) 50cm

## CVE011B

Panchetta in faggio imbottita in tessuto/pelle cliente capitonné con traverso intagliato a mano.  
TESSUTO OCCORRENTE PER L'IMBOTTITURA MT 2 IN H MT 1,40, PELLE 3 MQ  
Dimensioni totali L 130 x P 50 x H 50 cm

*Small bench in beech upholstered in customer's fabric/leather, with upper beam inlaid by hand. FABRIC REQUIRED FOR UPHOLSTERING MT 2 H MT 1.40 / LEATHER 3 SQ.*  
Total dimensions (W) 130 x (D) 50 x (H) 50cm





## CVE006T

Panchetta imbottita in tessuto.  
Dimensioni totali  
L 150 x P 45 x H 46 cm

*Bench upholstered in fabric.  
Total dimensions  
(W) 150 x (D) 45 x (H) 46cm*

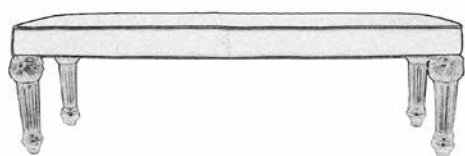

## CVE006P

Panchetta imbottita in pelle.  
Dimensioni totali  
L 150 x P 45 x H 46 cm

*Bench upholstered in leather.  
Total dimensions  
(W) 150 x (D) 45 x (H) 46cm*

## CVE006B

Panchetta imbottita in tessuto/pelle cliente.  
TESSUTO OCCORRENTE PER L'IMBOTTITURA  
MT 1 IN H MT 1,40, PELLE 1,50 MQ  
Dimensioni totali L 150 x P 45 x H 46 cm

*Bench upholstered in customer's  
fabric/leather. FABRIC REQUIRED FOR  
UPHOLSTERING MT 1 H MT 1.40 / LEATHER  
1.5 SQ. Total dimensions  
(W) 150 x (D) 45 x (H) 46cm*

## CVE001T

Panchetta imbottita in tessuto.  
Dimensioni totali L 100 x P 45 x H 70 cm

*Bench upholstered in fabric.  
Total dimensions (W) 100 x (D) 45 x (H) 70cm*

## CVE001P

Panchetta imbottita in pelle.  
Dimensioni totali L 100 x P 45 x H 70 cm

*Bench upholstered in leather.  
Total dimensions (W) 100 x (D) 45 x (H) 70cm*

## CVE001B

Panchetta imbottita in tessuto/pelle cliente.  
TESSUTO OCCORRENTE PER L'IMBOTTITURA MT 1,5 IN H 1,40, PELLE 2,5 MQ  
Dimensioni totali L 100 x P 45 x H 70 cm

*Bench upholstered in customer's fabric/leather.  
FABRIC REQUIRED FOR UPHOLSTERING MT 1.5 H MT 1.40 / LEATHER 2.5 SQ.  
Total dimensions (W) 100 x (D) 45 x (H) 70cm*

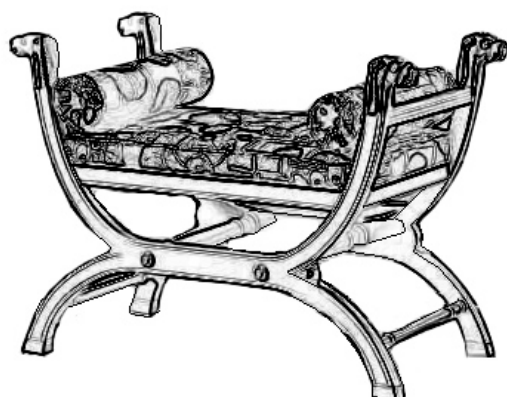













## CVE008T

Divano imbottito come in foto.  
Dimensioni totali L 410 x P 100 x H 85 cm

*Sofa upholstered as shown in the picture.  
Total dimensions (W) 410 x (D) 100 x (H) 85cm*



## CVE009T

Pouf imbottito come foto.  
Dimensioni totali L 100 x P 100 x H 45 cm

*Pouffe upholstered as shown in the picture.  
Total dimensions (W) 100 x (D) 100 x (H) 45cm*

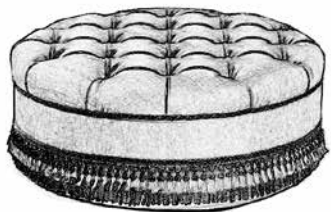







## CVE010T

Divano imbottito come foto.  
Dimensioni totali L 235 x P 110 x H 85 cm

Sofa upholstered as shown in the picture.  
Total dimensions (W) 235 x (D) 110 x (H)  
85cm







## CVE025T

Divano imbottito in tessuto con gambe e traversi intagliati a mano.  
Dimensioni totali  
L 180 x P 78 x H 94 cm

*Sofa upholstered in fabric with legs and beam inlaid by hand.  
Total dimensions  
(W) 180 x (D) 78 x (H) 94cm*

## CVE025P

Divano imbottito in pelle con gambe e traversi intagliati a mano.  
Dimensioni totali  
L 180 x P 78 x H 94 cm

*Sofa upholstered in leather with legs and beam inlaid by hand.  
Total dimensions  
(W) 180 x (D) 78 x (H) 94cm*

## CVE025B

Divano imbottito in bianco o in tessuto/ pelle cliente con gambe e traversi intagliati a mano. TESSUTO OCCORRENTE PER L'IMBOTTITURA MT 9 IN H MT 1,40, PELLE 15 MQ  
Dimensioni totali L 180 x P 78 x H 94 cm

*Sofa upholstered in customer's fabric/ leather with legs and beam inlaid by hand.  
FABRIC REQUIRED FOR UPHOLSTERING MT 9 H MT 1.40 / LEATHER 15 SQ. Total dimensions  
(W) 180 x (D) 78 x (H) 94cm*

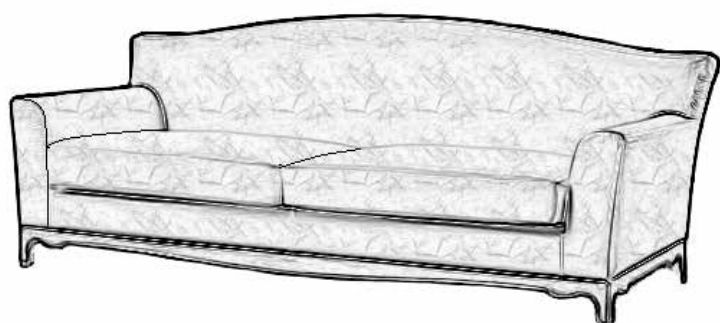

## CVE004P

Divano imbottito in pelle "stampata Cocco / Vitello" con profilo inferiore in legno sagomato, come foto.  
Dimensioni totali  
L 230 x P 90 x H 85 cm

*Sofa upholstered in leather "Cocco / Veal print" with lower profile in contoured wood, as shown in the picture.  
Total dimensions  
(W) 230 x (D) 90 x (H) 85cm*

## CVE005P

Divano imbottito in pelle "stampata Cocco / Vitello" con profilo inferiore in legno sagomato, come foto.  
Dimensioni totali  
L 180 x P 90 x H 85 cm

*Sofa upholstered in leather "Cocco / Veal print" with lower profile in contoured wood, as shown in the picture.  
Total dimensions  
(W) 180 x (D) 90 x (H) 85cm*



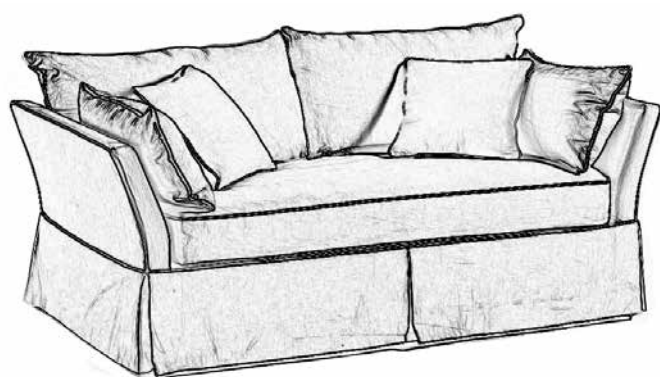

## CVE007T

Divano imbottito in tessuto come foto.  
Dimensioni totali L 175 x P 100 x H 90 cm

*Sofa upholstered in fabric as shown in the picture.  
Total dimensions (W) 175 x (D) 100 x (H) 90cm*

finish  
**finitura**







G. GUARESCHI  
ENCICLOPEDIA  
DI  
CHIMICA

G. GUARESCHI  
ENCICLOPEDIA  
DI  
CHIMICA

G. GUARESCHI  
ENCICLOPEDIA  
DI  
CHIMICA

G. GUARESCHI  
ENCICLOPEDIA  
DI  
CHIMICA

G. GUARESCHI  
ENCICLOPEDIA  
DI  
CHIMICA

G. GUARESCHI  
ENCICLOPEDIA  
DI  
CHIMICA

X  
ENCICLOPEDIA

VI  
ENCICLOPEDIA

II

III

IV

V



legno  
wood



**N1A**  
Noce Anticato  
*Antique finish Walnut*



**C1A**  
Ciliegio anticato  
*Antique finish cherry*



**C3A**  
Ciliegio chiaro anticato  
*Light cherrywood,  
aged effect*



**C5A**  
Ciliegio anticato 2009  
*2009 Cherrywood, aged  
effect*



**C7A**  
Ciliegio francese  
anticato  
*Antique finish French  
cherry*



**C9N**  
Ciliegio tinto mogano,  
non anticato  
*Mahogany tinted cherry,  
without aged-effect*



**V2B**  
Ciliegio CV2 anticato  
brillante  
*Cherry CV2, aged-effect  
and bright finish*



**D0A**  
Ciliegio CD0 anticato,  
effetto del passato  
*Cherrywood CD0,  
aged and antique effect*



**D3A**  
Ciliegio CD3 anticato  
*Cherrywood CD3, aged  
effect*



**T1A**  
Ciliegio P34 torrone  
anticato  
*Cherrywood P34  
"Torrone", aged-effect*



laccato  
lacquered



**401**  
Foglia oro  
*Gold foil*



**402**  
Foglia argento  
*Silver foil*



**403**  
Nero sfumato laccato  
argento  
*Black vanished  
lacquered Silver*



**15A**  
Panna antiquariato  
anticato consumato  
e patinato *Lacquered  
cream consumed,  
antique and gloss finish*



**22A**  
Bianco antiquariato anticato  
consumato, e patinato  
*Lacquered white consumed,  
antique and gloss finish*



**00A**  
Grigio oltremare patinato, anticato,  
consumato *Lacquered grey  
ultramarine consumed, antique  
and gloss finish*



**K0A**  
Tinta wengé anticato  
*Wengé colour, aged effect*



**20P**  
Grigio patinato  
*Grey, patinated*

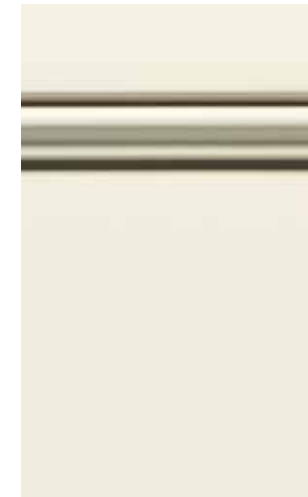

**50P**  
Ral 9010, patinato  
*Ral 9010, patinated*



**51P**  
Ral 9001, patinato  
*Ral 9001, patinated*

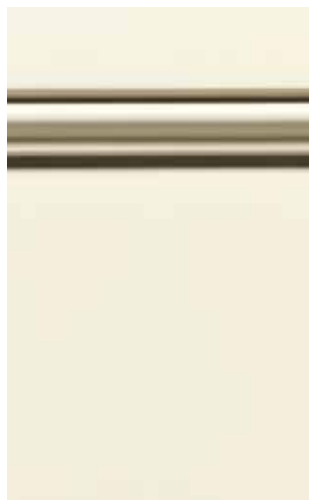

**52P**  
Mil 005, patinato  
*Mil 005, patinated*

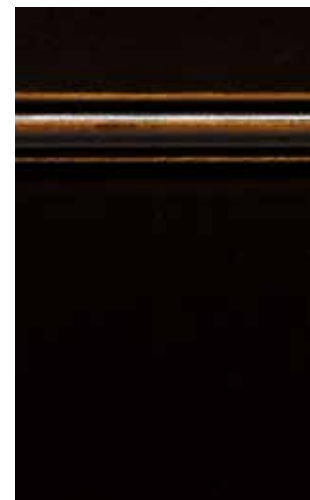

**53C**  
Nero consumato  
*Black consumed*

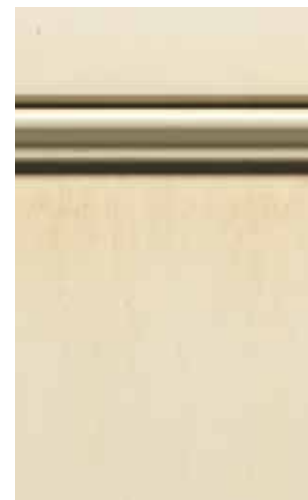

**62P**  
Corda patinato  
*Ecrù, patinated*



**50C**  
Ral 9010, patinato corda  
*Ral 9010, patinated ecrù*

Le finiture sono eseguite integralmente a mano secondo l'antica tradizione Bassanese. Le piccole imperfezioni non sono da considerarsi difetti, ma testimoniano l'origine artigianale dei manufatti.

*The finishes are fully handmade following the antique Bassano's tradition. Apparent imperfections are not to be considered defects but the evidence of the handmade origin of the product.*

pelle  
leather



**PL400**  
cocco bianco



**PL401**  
Cocco beige



**PL007**  
Rosso "Bentley"



**PL008**  
Bordeaux "Bentley"



**PL006**  
Testa di moro "Bentley"



**PL003**  
Nera



**PL010**  
Beige liscia



**PL009**  
Bianco latte liscia



**PL004**  
Verde



**PL001**  
Marrone



stoffa  
fabric



**Daisy PQ749**  
col. 01



**Daisy PQ749**  
col. 03



**Daisy PQ749**  
col. 04

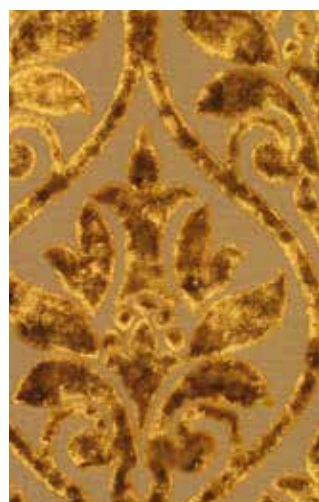

**Daisy PQ749**  
col. 06



**Saturnia**  
col. PQ744/02



**Saturnia**  
col. PQ743/02



**Saturnia**  
col. PQ744/04



**Saturnia**  
col. PQ743/04



**Fusion**  
col. 11

stoffa  
leather



**Fusion**  
col. 20



**Fusion**  
col. 32



**Fusion**  
col. 09



**Penelope**  
col. PQ 785/05



**Penelope**  
col. PQ 785/03



**Penelope**  
col. PQ 785/04



**Vivienne**  
dis. 22 col. 01

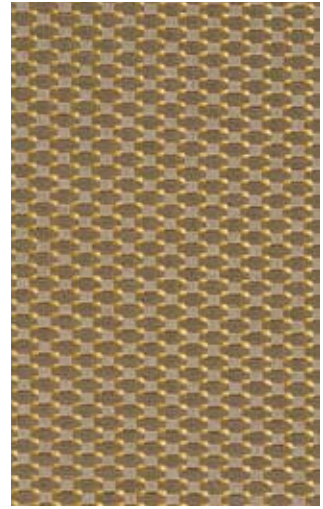

**Vivienne**  
dis. 23 col. 01



**Vivienne**  
dis. 25 col. 01



**Vivienne**  
dis. 22 col. 03

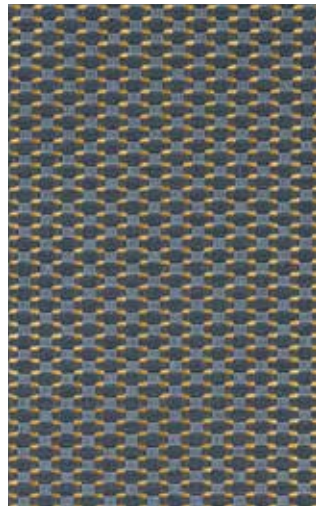

**Vivienne**  
dis. 23 col. 03



**Vivienne**  
dis. 25 col. 03





**Vivienne**  
dis. 22 col. 02



**Vivienne**  
dis. 23 col. 02



**Vivienne**  
dis. 25 col. 02



**Vivienne**  
dis. 22 col. 06



**Vivienne**  
dis. 23 col. 06



**Vivienne**  
dis. 25 col. 06

Il catalogo è di proprietà esclusiva di Prestige Srl - Tutti i diritti sono riservati.  
È vietata ogni forma di riproduzione anche parziale.  
La stampa tipografica non sempre permette la fedele riproduzione dei colori e delle tinte rispetto agli originali. La ditta si riserva in qualsiasi momento la facoltà di apportare modifiche tecniche e dimensioni ai modelli, anche senza preavviso.

This catalogue is the exclusive property of Prestige Srl - All rights reserved.  
Any form of total or partial reproduction of the catalogue is strictly forbidden.  
The printing process doesn't always permit a faithful reproduction of colours and tones as compared to the original. The company reserves the right to change, at any time and without prior warning, the technical specifications and dimensions of the articles.

AZIENDA CERTIFICATA SECONDO SISTEMA UNI EN ISO 9001  
COMPANY CERTIFIED IN ACCORDANCE WITH THE SYSTEM UNI EN ISO 9001

Photo: Riccardo Urnato  
Concept: Valentina Capraro

Finito di stampare in settembre 2014 da Grafiche Gemma







Timeless Interiors

**Prestige S.r.l.**

via Matteotti, 7 | 36056 Tezze sul Brenta (VI) | T. +39.0424.561315 | F. +39.0424.561470  
www.prestigemobili.com | info@prestigemobili.com