

TATO

DREAMED AND MADE IN ITALY

DREAMED AND MADE IN ITALY

TATO was conceived to do things well. This is what it's dealing with. There's a deep knowledge arising from practice. Doing things well for a company producing lighting design and furnishing items means to express a way to be and a precise attitude. It means to purposely design in an understated way a personal idea of what freedom is, a personal idea of new, of something you don't look for, because you live with it every day.

TATO's idea of design translates into a new economic and cultural scenario and in a future-oriented tradition of manual dexterity, knowledge of gestures, materials and handicrafts. All those elements that make Italy well known in the world. There is no industry that can do well without handicrafts.

The constant manual work on the materials and the forms they can take, the surprise and the intimate familiarity that derive from them, gives us back a range of objects representing characters, talking to us within an architecture, feeling always comfortable and behaving. These objects can keep their value over time. Good design begins with people. TATO surrounds itself with people who are similar but also with very different. Not only architects and designers but a large intellectual group aiming to research and experiment. Particularly significant are the relationships with the local artisans in the area where the company was born, and the international relationship, helping to spread its ideas. Listening to people is crucial. More and more people, sophisticated people, looking for history and culture in the things they choose.

TATO takes culture into particular account and is engaged in many processes. We like to dig out from history those objects that are produced today but belong to our recent, or even not so recent, past.

IT'S NOT JUST ABOUT GOOD DESIGN

There is a special quality in some design firms, which is considering the aesthetic purpose as their basic foundation, even from an economic point of view. That's because cultural contents are more and more an expression of people's choices.

TATO's proposal is a newly structured and poetic model where the visual research goes together with the industrial experimentation, the philology of materials and techniques, both new and old, the discovery of new production geographies in order to build a catalogue in which the content stimulus and the edition methods are more privileged than the manufacturing limitations and the assembly line repetitiveness.

It's not just about good design: it's about a more complex vision of the world, of things and of living, it's about an attitude that brings together a network of knowledge including the hand-made and machine-made and that is related with the more anthropological aspects of craftsmanship and industry.

Choosing good authors is necessary to transfer the art phenomenology in the object and to make aesthetic and functional information be coincident. It's important to practice an intense professional and affective relationship between client, designer and company that belongs to the culture of the project. So the object becomes a part of a vast and very articulate narrative program that, in pursuing a personal image, redefines the relationship between industrial production and production of knowledge.

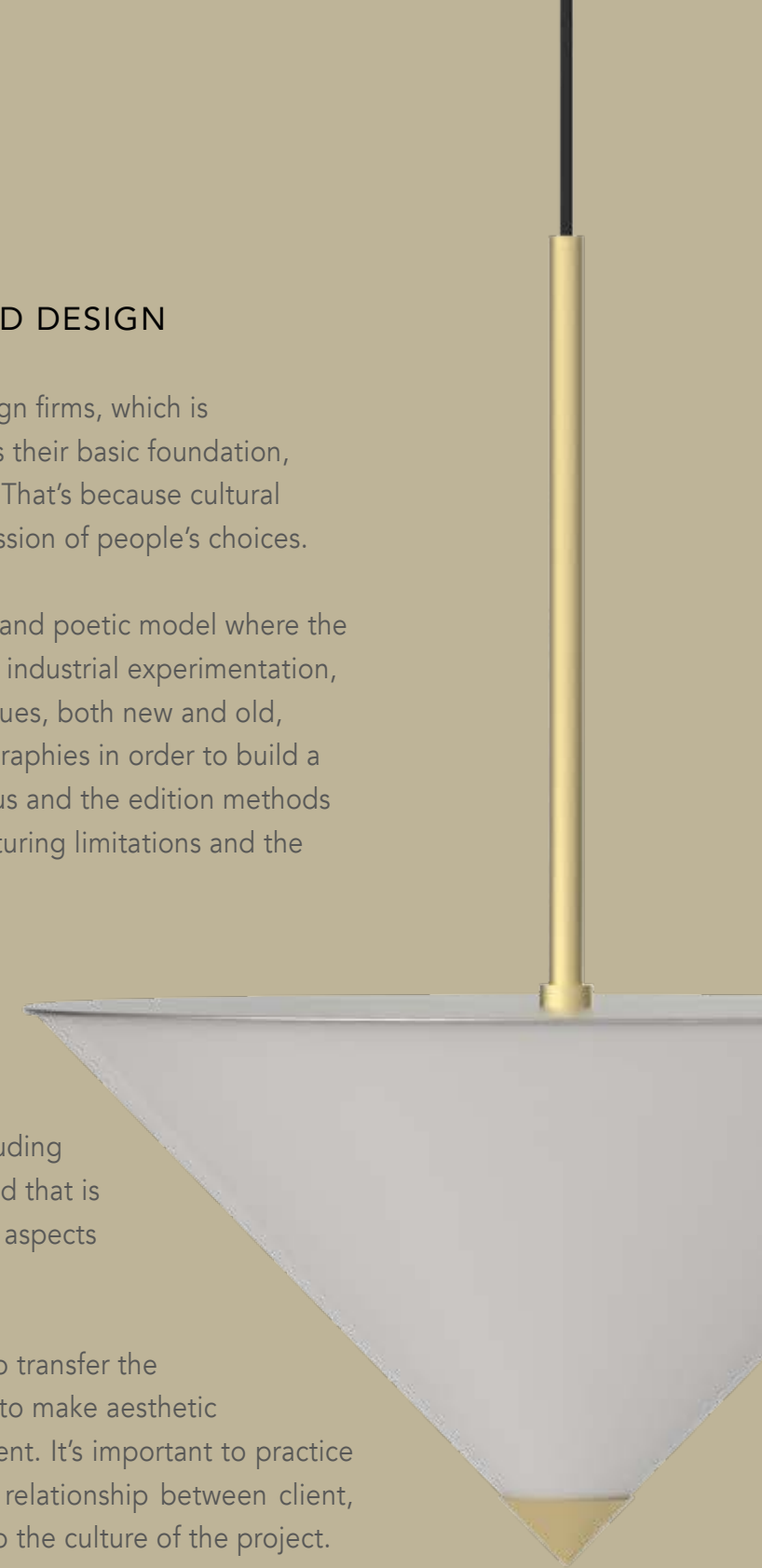
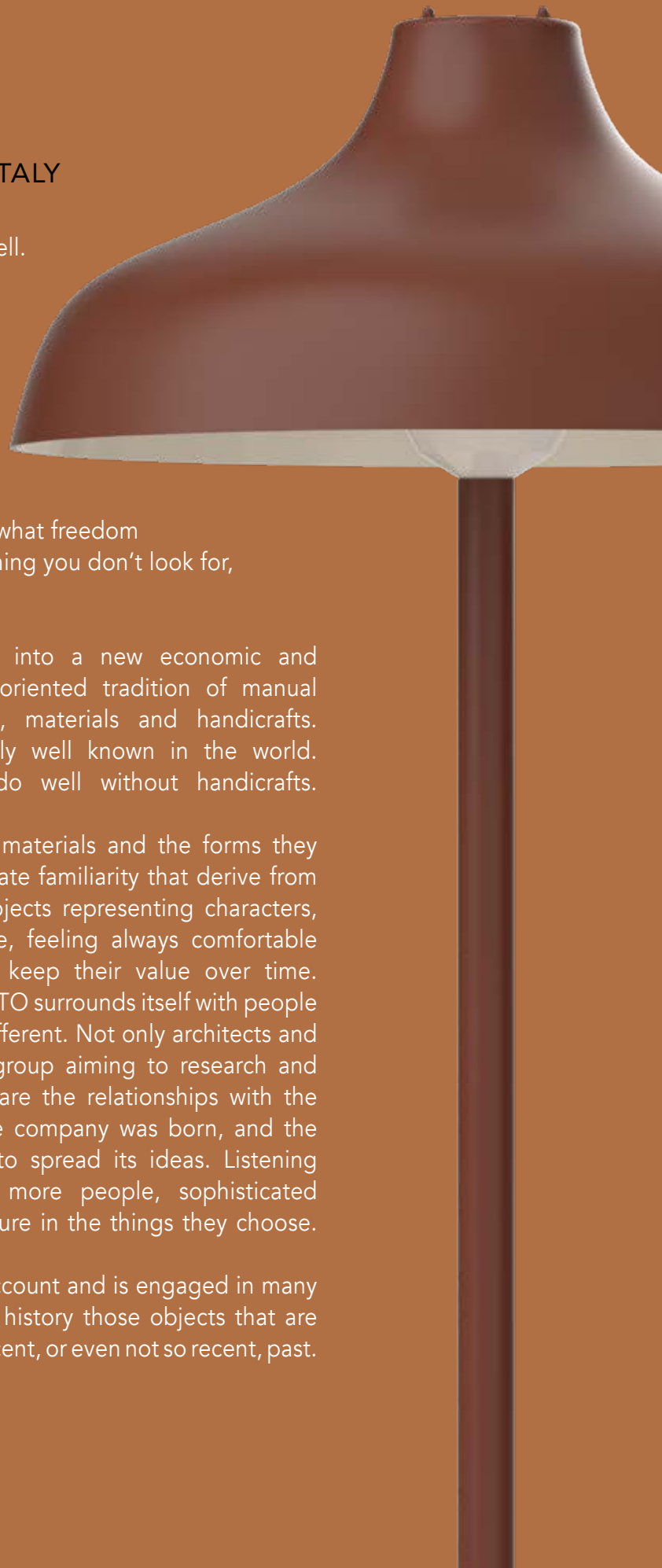



Modern designers



Corrado Corradi Dell'Acqua

Corrado Corradi Dell'Acqua (Milan 1905 - Varese 1982) was a law expert, an amateur writer, and quietly became a designer. His dachshund's name was Azucena like the company Corradi had started in 1947 with two other young Milanese intellectuals, Luigi Caccia Dominioni and Ignazio Gardella. Corrado Corradi had fun designing chintz with Luchino Visconti and he liked ceramic. He designed lamps made with glass from Milan's tramcars and many other objects for the house, with a precise idea of living in mind.

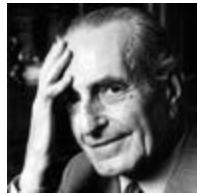

Ignazio Gardella

Ignazio Gardella (Milan, 1905 - Oleggio, 1999) was one of the leading figures in Italian 20th century architecture. Even before the war he had performed a series of jobs for the upper classes of Piedmont and Lombardy, clients whom he was able to interpret in many important projects in the period of Reconstruction when he was at the forefront in proposing a new idea of architecture. In 1947, he founded Azucena with Luigi Caccia Dominioni and Corrado Corradi Dell'Acqua. Until the 1990s, Gardella would continue designing furniture and accessories, as well as carrying on his extraordinary activity as architect.



Eugenio Gerli

Already experimenting with new materials such as plastic felt and curved plywood before becoming an architect, Eugenio Gerli (Milan, 1923 - 2013) opened his firm in 1949. 1957 marked the start of a long and extraordinary partnership with Osvaldo and Fulgenzio Borsani and Techno, for whom he designed the historic operating system Graphic (1968) and other icons such as the PS142 and S142 seats. In the 1970s, he was joined in the business by his sons, Enrico and Guido, who now also take care of the Archive.



Gio Ponti

Gio Ponti is one of the most important figures in 20th century architecture and arts. From 1923 to 1930 he was artistic director of Richard Ginori; in 1928 he founded the magazine "Domus", which would be followed by other great publishing feats such as "Stile". Dating from the late 1920s are the "typical homes", which combined the concept of Italianness with an interest in rationalist theories. Right from the start, he took part in the Triennale design exhibitions in Milan. With Antonio Fornaroli and Alberto Rosselli, in the studio in Via Dezza which would become his home, he conceived an extraordinary series of projects, expressing his "finite form" theory in the fields of furniture with the "organized walls", design and architecture.



Alberto Rosselli

Alberto Rosselli (Palermo, 1921 - Milan, 1976) graduated just after the end of the war from the Architecture Faculty of the Politecnico di Milano. From the start of his career and in parallel to his activity as architect, he carried out theoretical studies and worked as a designer in different fields, from product design to furniture, to transport. In 1953, as director, he brought out the magazine "Stile Industria". In 1956 he was Chairman of the Italian Association of Industrial Design (ADI). His intense work as architect was carried out in the Ponti-Fornaroli-Rosselli studio, becoming a co-creator in its projects in the 1950s.

Contemporary designers



Antonia Astori

Antonia Astori was born in Melzo (Milan) in 1940. She graduated in Industrial and Visual Design at the Athenaeum of Lausanne in 1966. Since 1968, she has worked as a designer for the Italian company Driade, creating some important system and furniture designs and helping to shape the corporate image with her outfitting and exhibitions. Her activity as a designer goes alongside her work as interior designer, with projects for houses, offices, showrooms and stores.



Lorenza Bozzoli

Lorenza Bozzoli was born in Milan, where she studied at the Accademia di Belle Arti di Brera. In 1985 she began working as a fashion designer for Fiorucci, Basile, Plein Sud, Sergio Rossi and Camper among others. In 1996 she became passionately involved in industrial design for Antiquità, Viceversa, Alessi, Dilmos, Dedon and Moooi. She has participated in important exhibitions in Italy and abroad. She lives and works in Milan where she has her own design studio.



Giulia and Guido Guarnieri

Giulia and Guido Guarnieri are fond of Milan and 1950s and 60s design. After graduating from the Politecnico di Milano, they became involved in various professional projects regarding design, video art and marketing, both in Italy and in Europe. Giulia is currently a brand manager for an Italian fashion company and Guido is an art director for a design company.



Hisham Kulhanek

Hisham Kulhanek was born in Prague in 1958. In 1970 he moved to Amsterdam with his family. After studying at the Delft University of Technology, he decided to move to Milan where he started a long partnership with the Japanese designer Makio Hasuike. Now he runs a multidisciplinary studio focused on product design. He has been a teacher at the Istituto Europeo di Design (IED) in Milan, and has run some workshops at the Domus Academy and at the Politecnico di Milano for the Master's degree in Strategic Design.



Gianluigi Landoni

Gianluigi Landoni is an architect and designer. He graduated from the Politecnico di Milano. After many experiences in architecture and industrial design studios, since 1994 he has worked as a freelance alongside numerous design companies. He has participated in various exhibitions and contests for both public and private works, receiving awards and commendations. He has been a teacher at the Istituto Europeo del Design (IED) in Milan.



Matteo Nunziati

Matteo Nunziati is considered one of the most influential international architects and designers of his generation. He received numerous important awards for his works in product design; his projects, exclusive and enhanced by the skillful selection of materials and furnishings, usually chosen from the production excellence of Made in Italy design, have been published in the major Italian and international magazines. His solid experience led Nunziati carry out teaching activities at important institutions such as Domus Academy, the National Taipei University of Technology, the IDI Interior Design Institute of Milan and the Tshinghua University Shenzhen in China.



Alessandro Pasinelli

Alessandro Pasinelli began by studying fashion and textile design in Milan. In 2004 he opened his own multidisciplinary Design Studio dealing with design, interior, styling and art direction. He collaborates with many companies, editorial offices and photographers. He collects design pieces by great Italian Maestri, loves green projects and the contamination between art, fashion and design, always looking for new communicative languages. He lives and works in Milan, collaborating with a multitasking team able to offer varied creative solutions.



Studio 2046

Founded by Daniele Daminelli. "I like the idea of bringing elements of the past into the future." Interior designer by training and founder of Studio2046, Daniele Daminelli imagines and designs contemporary items that combine the strength of industrial processes with the refinement of traditional and artisanal work. In his design practice the attention is especially placed on the details, on the harmony of proportions, on the relationship between materials and on the calibration of the colors.



ALZABILE
14



ANITA
20



ARENZANO
24

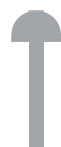

BABILA
42



BEGHINA
48



BESANA
54



BIBA
58



COPPA APERTA
64



DE-LUX
72



DOPPIO VETRO
80



GALLERIA
86



ICONES
92



JIL
98



LEA
102



LUNA
110



NETTA
118



OLLY
122



ORSOLA
128



PAGODA APPLIQUE
132



PAGODA PIANTANA
136



PAOLINA
140



PRISMA
144



SIDEREA
150

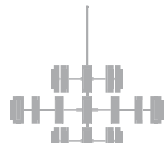

VARESINA
154



VOX
160

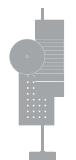

WALLIE
166



ACCA
178



ANGOLO
186



DOMUS
194



FAGIOLO
200

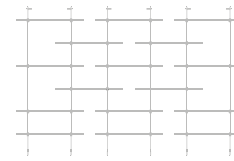

LIBRERIA MODULARE
204



LIDO
208



MONFORTE
214



MONTECARLO
220



PIEDI REGOLABILI
224



R63
230



SELLA
234



STAND
238

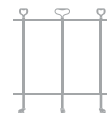

TRE MANIGLIE
244



TRECENTOSESANTA
248



TRUNO
256



ZOAGLI
260

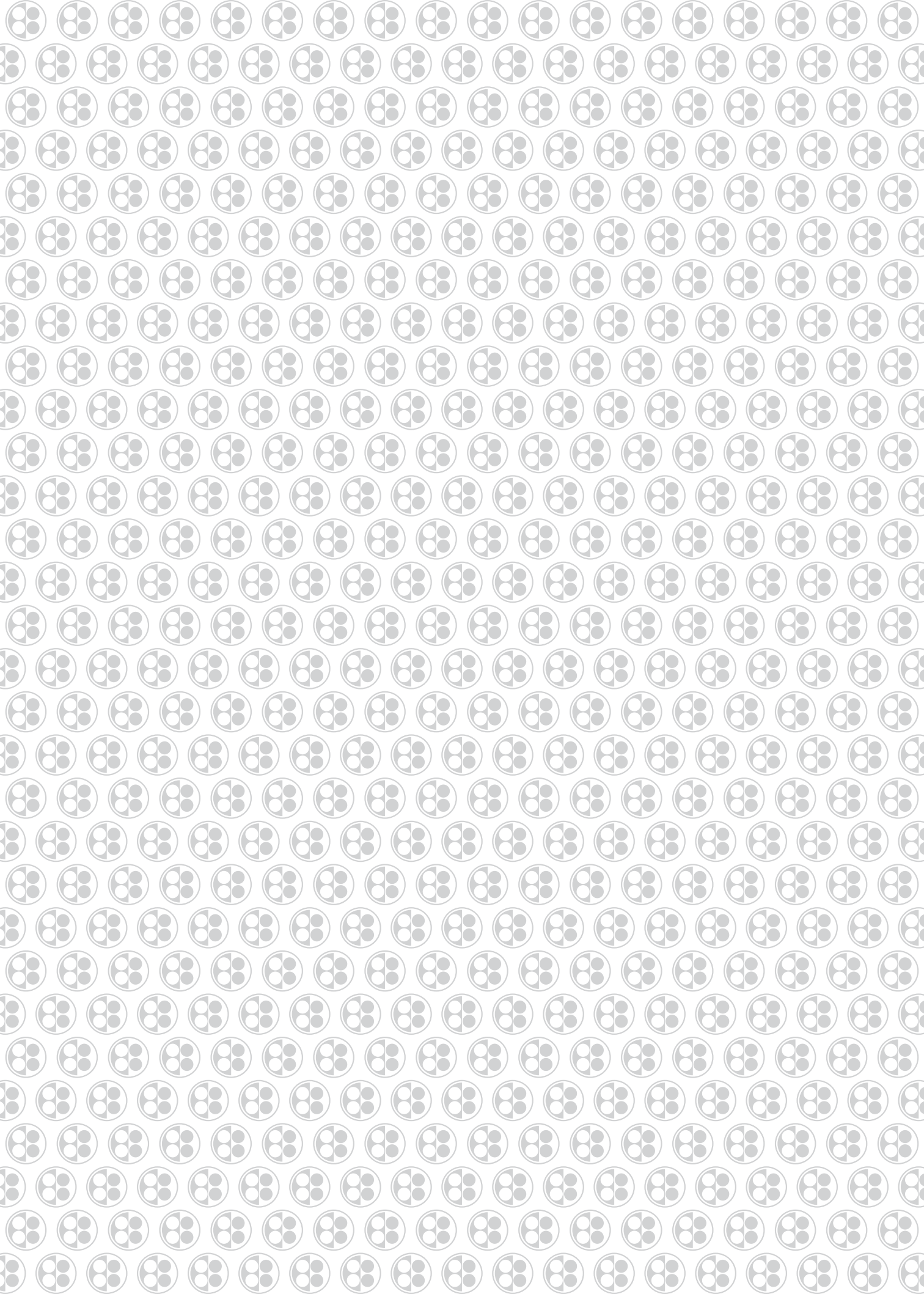

LIGHTING

Alzabile

designed by Ignazio Gardella
1948 / 2017

*Featured in the
permanent collection of
New York's **MoMA**.*

Details

Type: reading lamp
Materials: marble / brass / aluminum
Weight: 5,5 kg
Insulation: class II / IP20
Bulbs: 1xLED E27/E26 806lm

Measurements

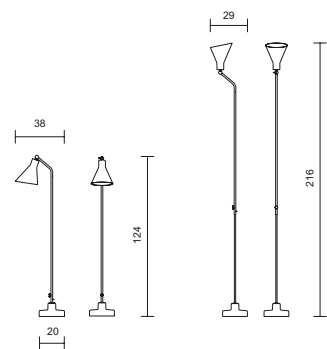

Finishings

Body



brass



chrome

Shade



brass



chrome



glossy white



manganese

Base



marquina



carrara



grey



© ARCHIVIO STORICO GARDELLA



Anita

designed by Lorenza Bozzoli
2016

Details

Type: table lamp
Materials: marble / brass / glass
Weight: 7 kg
Insulation: class II / IP20
Bulbs: 3xLED E14/E12 470lm

Measurements

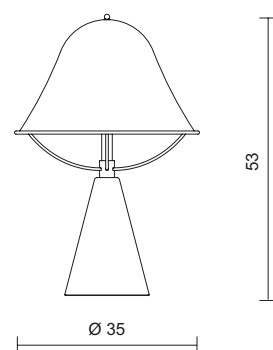

Finishings

Glass shade



satin white

Structure



chrome



satin bronze



satin brass

Base

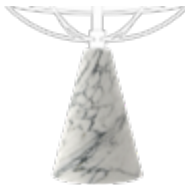

carrara



emperador



Arenzano

designed by Ignazio Gardella
1956 / 2018

Details

Materials: brass / iron / glass
Insulation: class II / IP20
Bulbs: 3xLED E14/E12 470lm



Models



table



table (low)



floor

Finishings

Body



brass

chrome

satin nickel

satin bronze

Glass shade



satin white



glossy green



Arenzano

Type: table lamp
Weight: 3,8 Kg

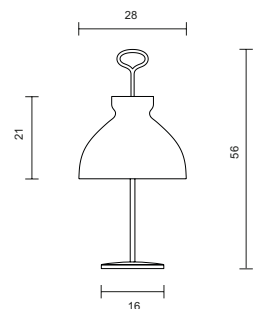



Arenzano Bassa

Type: table lamp
 Weight: 2,4 Kg

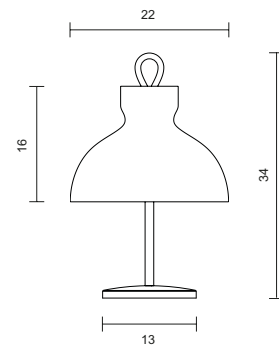

Arenzano Terra

Type: floor lamp
 Weight: 5,5 Kg

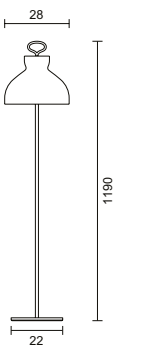



Arenzano Wireless

based on the design by Ignazio Gardella
1956 / 2023

*Rechargeable battery powered lamp,
easily portable.*



USB Type-C

Details

Type: battery powered table lamp
Materials: brass / iron / polycarbonate
Weight: 1,5 Kg
Insulation: class III / IP20
Bulbs: dimmable COB, 2700K, max 400lm
Duration: 8-10 hours at maximum intensity

Measurements

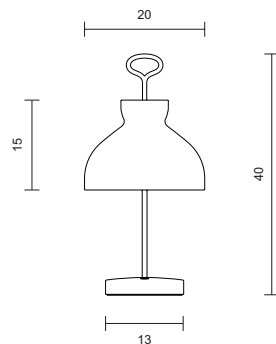

Finishings

Body



brass



chrome

Shade



satin white
translucent

Battery



rechargeable with
USB-C port
(cable included)



Arenzano Tre Fiamme

designed by Ignazio Gardella
1963 / 2019

Details

Materials: brass / glass / marble
Insulation: class II / IP20
Bulbs: 9xLED E14/E12 470lm



Models

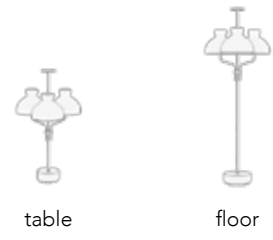

Finishings

Body



Base

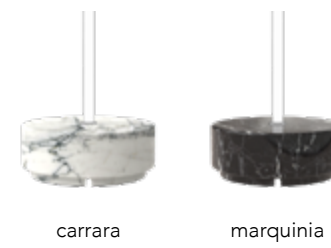

Glass shade



Arenzano Tre Fiamme Tavolo

Type: table lamp
Weight: 15 Kg

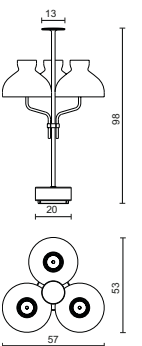



Arenzano Tre Fiamme Terra

Type: floor lamp
Weight: 19 Kg

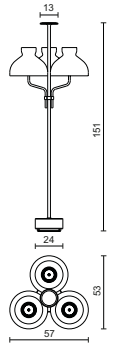

Babila

designed by Alessandro Pasinelli
2024

Details

Materials: aluminum / polycarbonate / iron
Insulation: class II / IP20
Bulbs: 3xLED E27/E26 806lm



Models



table S



table L



floor

Finishings

Body



brushed aluminum

Shade & accents



glossy white
translucent



glossy black
opaque



Babila Tavolo

Type: table lamp
Weight: 6,5 Kg / 7 Kg

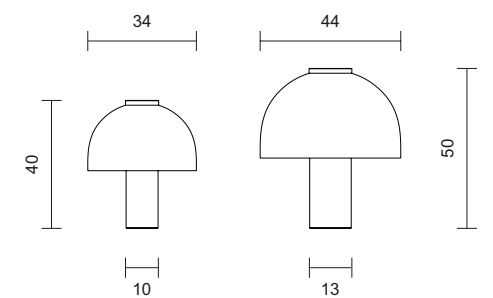



Babila Terra

Type: floor lamp
Weight: 9 Kg

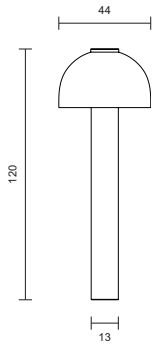

Beghina

designed by Giulia & Guido Guarnieri
2011



Details

Materials: brass / aluminum
Insulation: class II / IP20
Bulbs: 1xLED E14/E12 470lm

Models

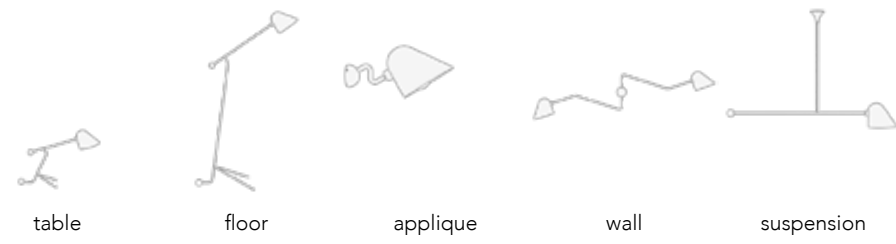

Finishings

Body

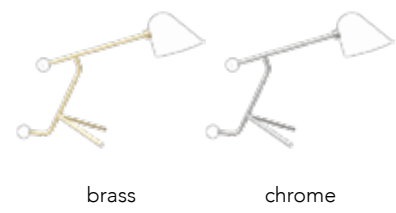

Shade & accents



Beghina Tavolo

Type: table lamp
Weight: 2 Kg

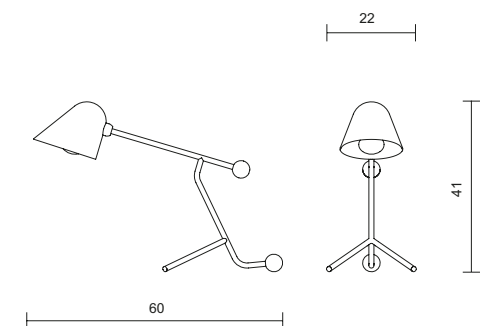



Beghina Terra

Type: floor lamp
 Weight: 3,5 Kg

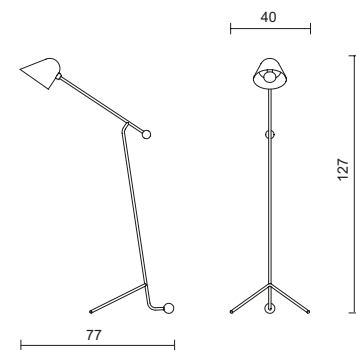

Beghina Applique

Type: applique lamp
 Weight: 0,8 Kg

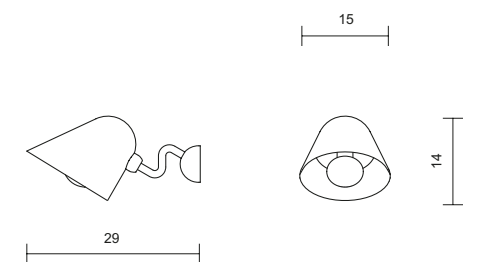

Besana

designed by Alessandro Pasinelli
2022

Details

Type: ceiling lamp
Materials: polycarbonate / iron / brass
Weight: 8 kg
Insulation: class I / IP20
Bulbs: 6xLED E14/E12 806lm

Measurements

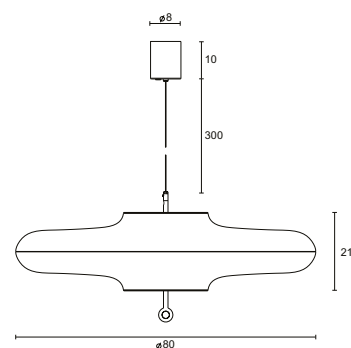

Models



ceiling

Finishings

Body



satin white plastic

Accents

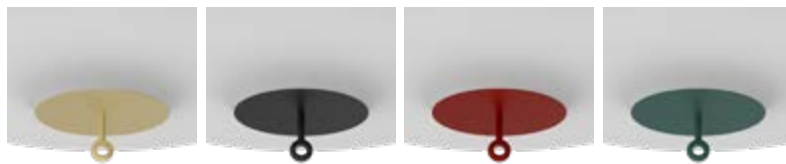

satin brass

matte black

china red

mint green



Biba

designed by Lorenza Bozzoli
2017

Details

Materials: brass / iron / glass

Insulation: class II / IP20

Bulbs: 1xLED E27/E26 806lm + 1xLED E14/E12 470lm

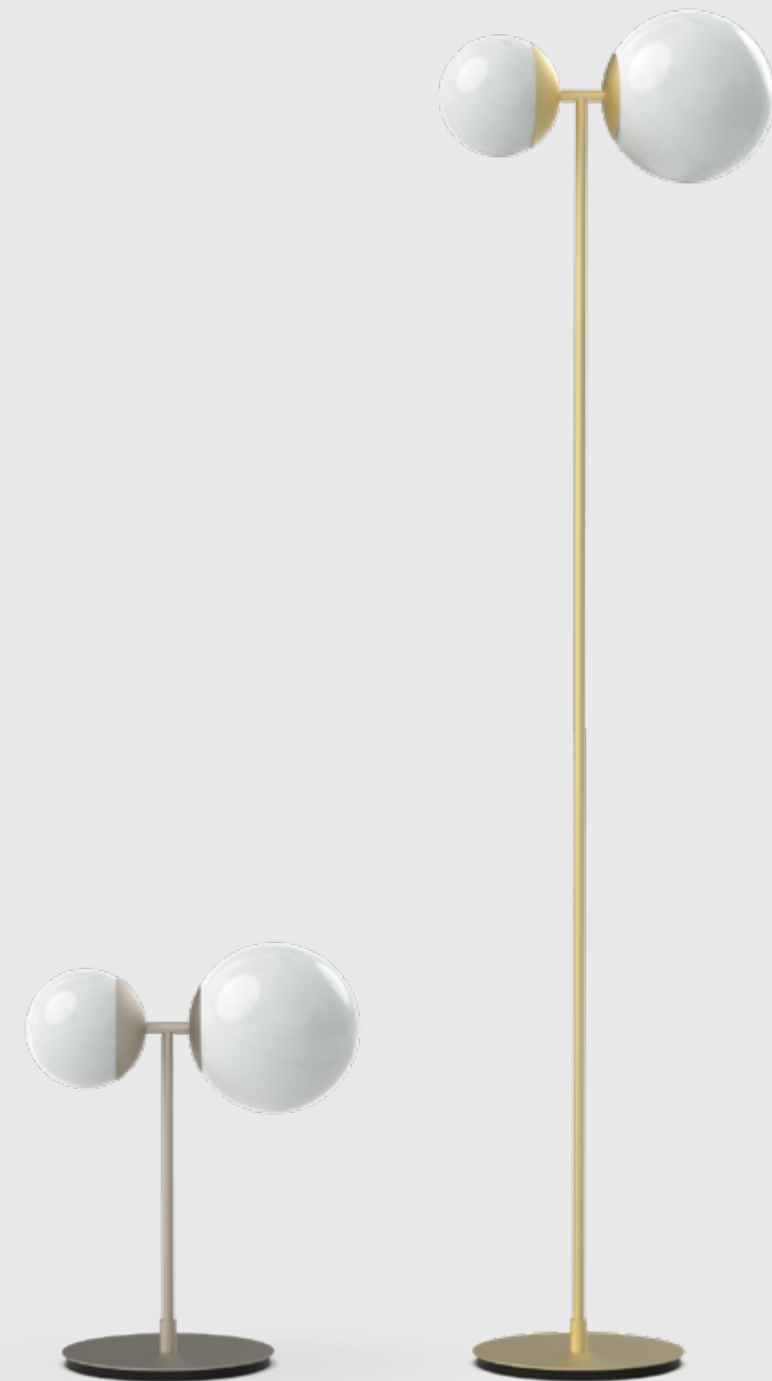

Models



table



floor



applique



suspension

Finishings

Body



satin brass

satin nickel

matte black

Glass shades



glossy white



Biba Tavolo

Type: table lamp
Weight: 6 Kg

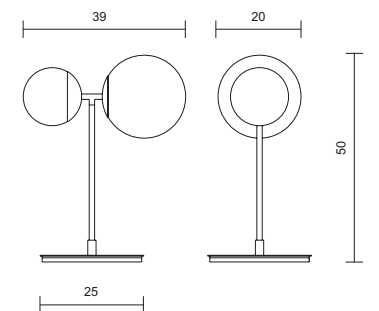



Biba Applique

Type: applique lamp
Weight: 2 Kg

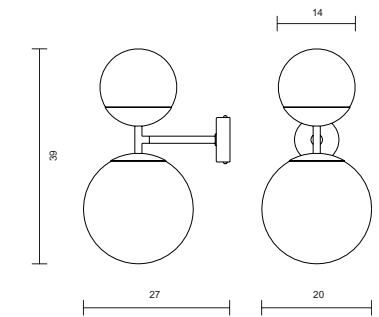

Biba Sospensione

Type: ceiling lamp
Weight: 4,5 Kg

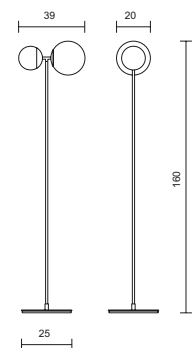
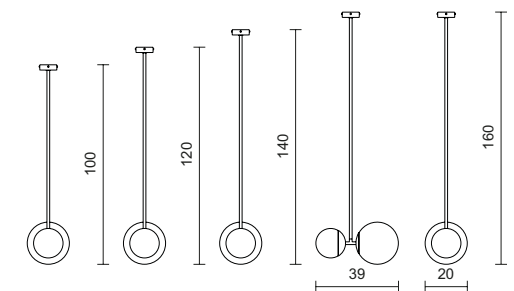

Biba Terra

Type: floor lamp
Weight: 6,5 Kg

Coppa Aperta

designed by Ignazio Gardella & Corrado Corradi Dell'Acqua
1954 / 2019



Details

Materials: brass / aluminum / glass
Insulation: class II / IP20
Bulbs: 1xLED E27/E26 806lm

Models



applique



floor

Finishings

Body



brass



chrome



satin nickel



brass



chrome

Shade holder



glossy black



silver

Marble base (floor model)



carrara



marquinia



Coppa Aperta Applique

Type: applique lamp
Weight: 1,5 Kg

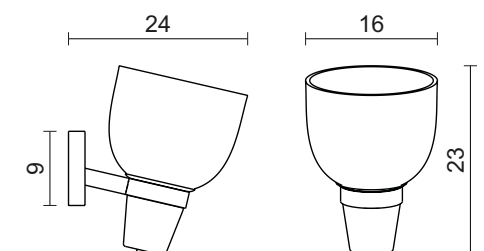





Coppa Aperta Piantana

Type: floor lamp
Weight: 6,5 Kg



De-Lux

designed by Gio Ponti
1955 / 2017

Details

Type: floor lamp
Materials: aluminum / iron / plastic
Weight: 3,5 ~ 8,5 kg
Insulation: class II / IP20
Bulbs: 1xLED E27/E26 2300lm

Measurements

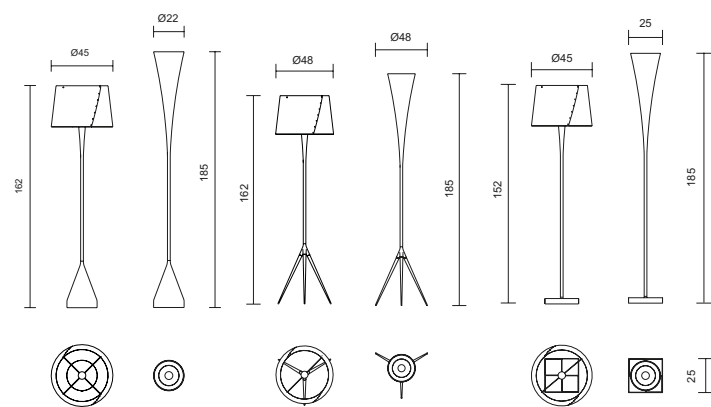

Finishings

Shade



plastic shade



cone

Base shape



"A"



"B"



"D"

"A" and "B" body color



gold



silver



matte black

"D" base tiles



white / blue



white / orange

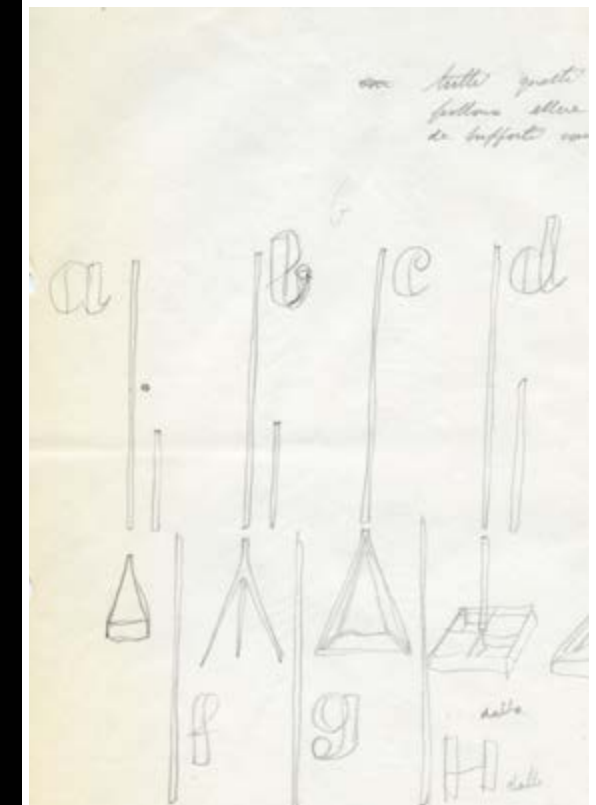
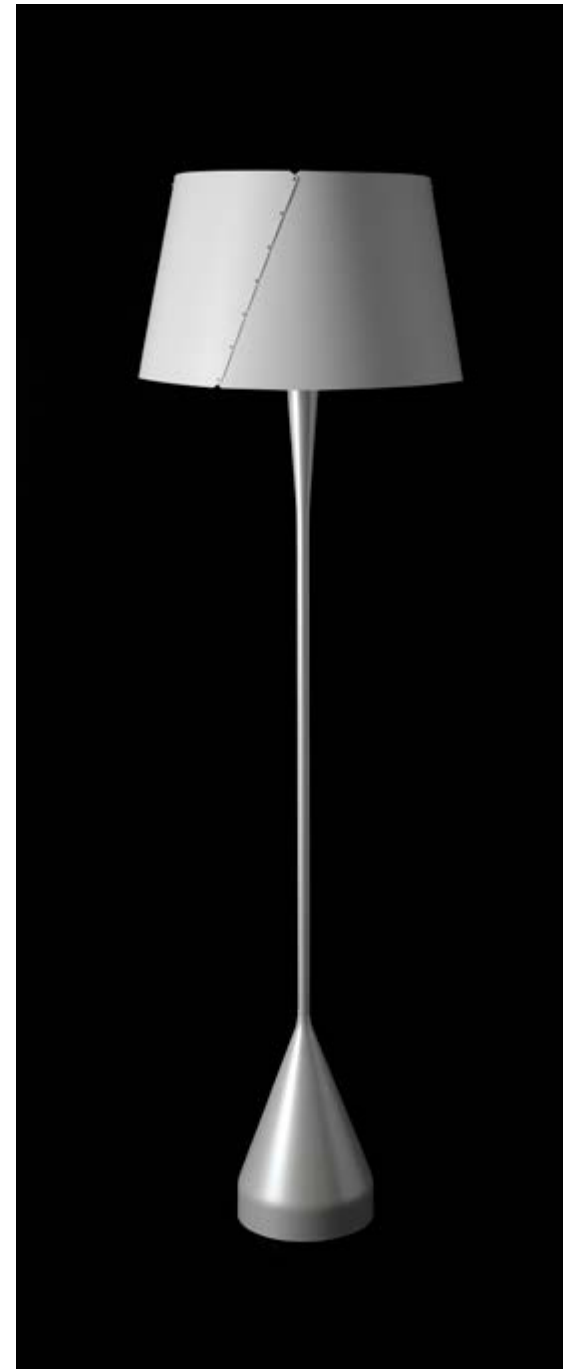





Doppio Vetro

designed by Ignazio Gardella
1955 / 2021

Details

Materials: brass / iron / glass
Insulation: class I / IP20
Bulbs: 3xLED E27/E26 806lm



Models

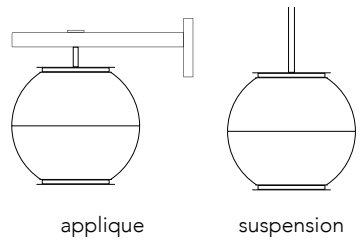

Finishings

Body

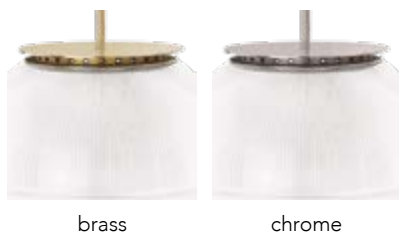

Doppio Vetro Applique

Type: wall lamp
Weight: 5,5 Kg

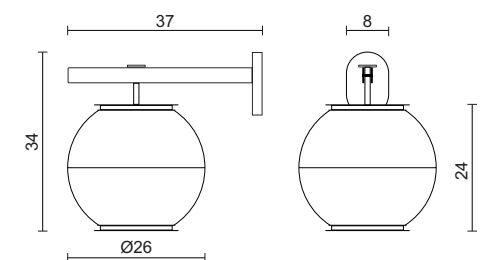



Doppio Vetro Sospensione

Type: ceiling lamp
Weight: 5 Kg

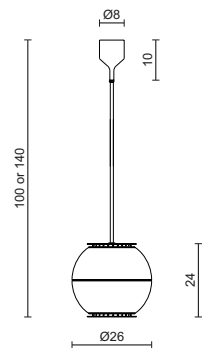

Galleria

designed by Ignazio Gardella
1958 / 2019

Details

Type: wall lamp
Materials: brass / glass
Weight: 2 / 3 / 5 / 7 / 8,5 kg
Insulation: class I / IP20
Bulbs: 1xLED E27/E26 806lm (each arm)

Measurements

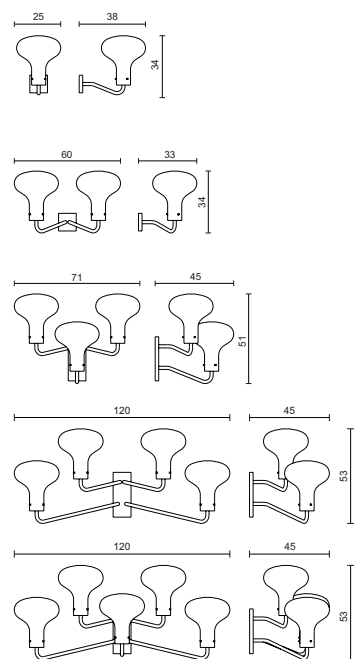

Finishings

Models



1 arm



2 arms



3 arms



4 arms



5 arms

Body

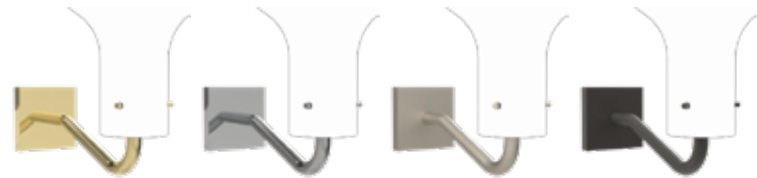

brass

chrome

satin nickel

satin bronze

Glass shade



satin white



COLLEZIONE GRASSI, GAM MILANO
© ARCHIVIO STORICO GARDELLA



Icones

designed by Lorenza Bozzoli
2019 / 2020

Details

Materials: aluminum / plastic / brass
Insulation: class II / IP20
Bulbs: 3xLED E27/E26 806lm



Models



table



floor



suspension

Finishings

Body



manganese



satin nickel

Accents



satin brass



satin nickel



Icones Tavolo

Type: table lamp
Weight: 8 Kg

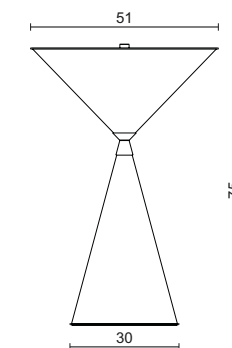

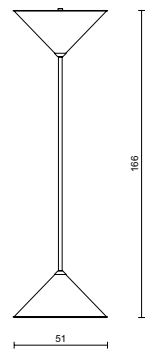

Icones Piantana

Type: floor lamp
Weight: 12 Kg

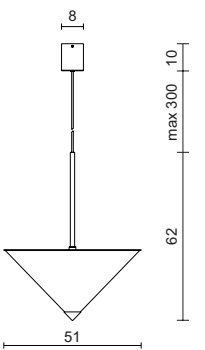

Icones Sospensione

Type: ceiling lamp
Weight: 4 Kg

Jil

designed by Lorenza Bozzoli
2016

Details

Type: table lamp
Materials: marble / brass / glass
Weight: 7,5 kg
Insulation: class II / IP20
Bulbs: 3xLED E14/E12 470lm

Measurements

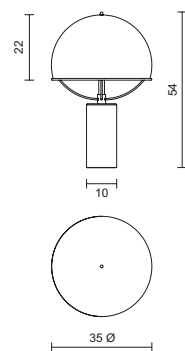

Finishings

Metallic structure

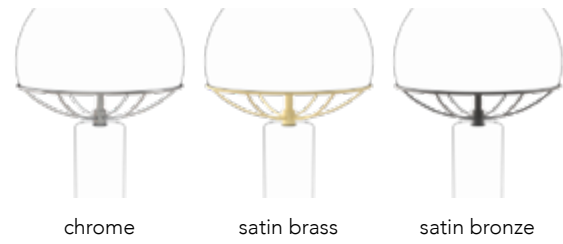

Marble base



Glass shade



Lea

designed by Matteo Nunziati
2019 / 2020

Details

Materials: marble / glass or polycarbonate
Insulation: class II / IP20



Models

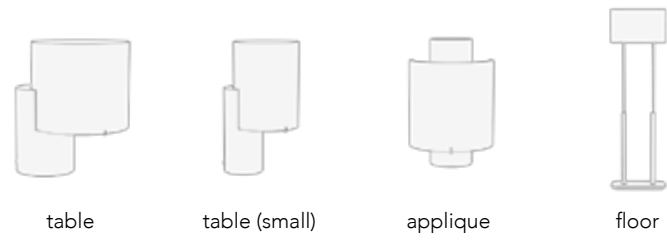

table

table (small)

applique

floor

Finishings

Marble base



carrara

marquinia

portoro

Glass shade



satin white
(table model)

Plastic shade



satin white
(small table model)

satin white
(applique model)

satin white
(floor model)



Lea

Type: table lamp
 Weight: 11 Kg
 Bulbs: 1xLED E27/E26 806lm

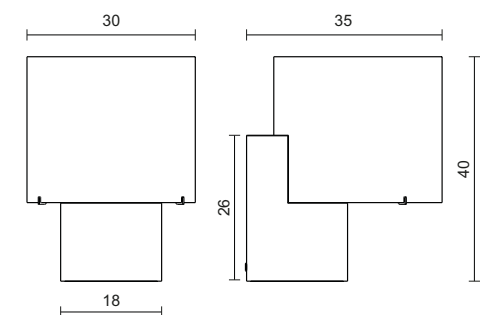



Leina

Type: table lamp
 Weight: 7 Kg
 Bulbs: 1xLED E14/E12 806lm

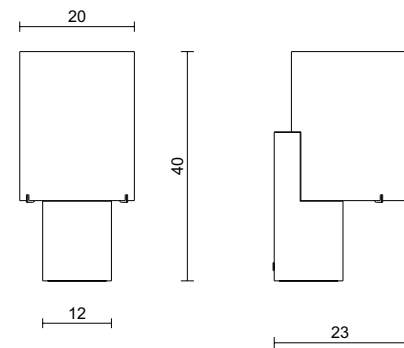

Lea Applique

Type: applique lamp
 Weight: 5 Kg
 Bulbs: 1xLED E14/E12 806lm

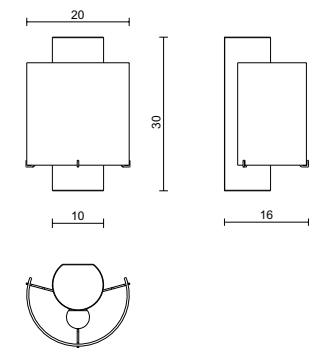

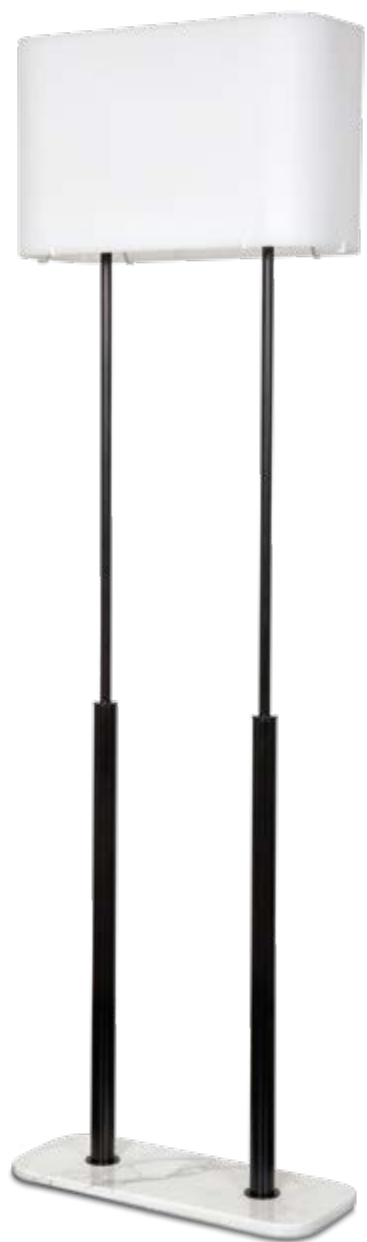

Lea Piantana

Type: floor lamp
Weight: 15 Kg
Bulbs: 2xLED E27/E26 2300lm

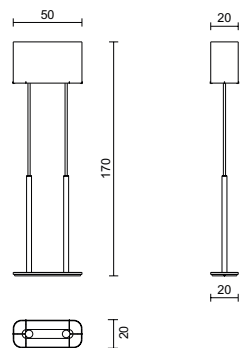

Luna

designed by Gio Ponti
1957 / 2018



Details

Materials: polycarbonate / brass / iron
Insulation: class II / IP20

Models



floor horizontal

floor vertical

ceiling

Finishings

Body



satin white

glossy white
and blue

glossy white
and orange

glossy white
and grey

Legs & accents



satin brass

satin nickel

brass

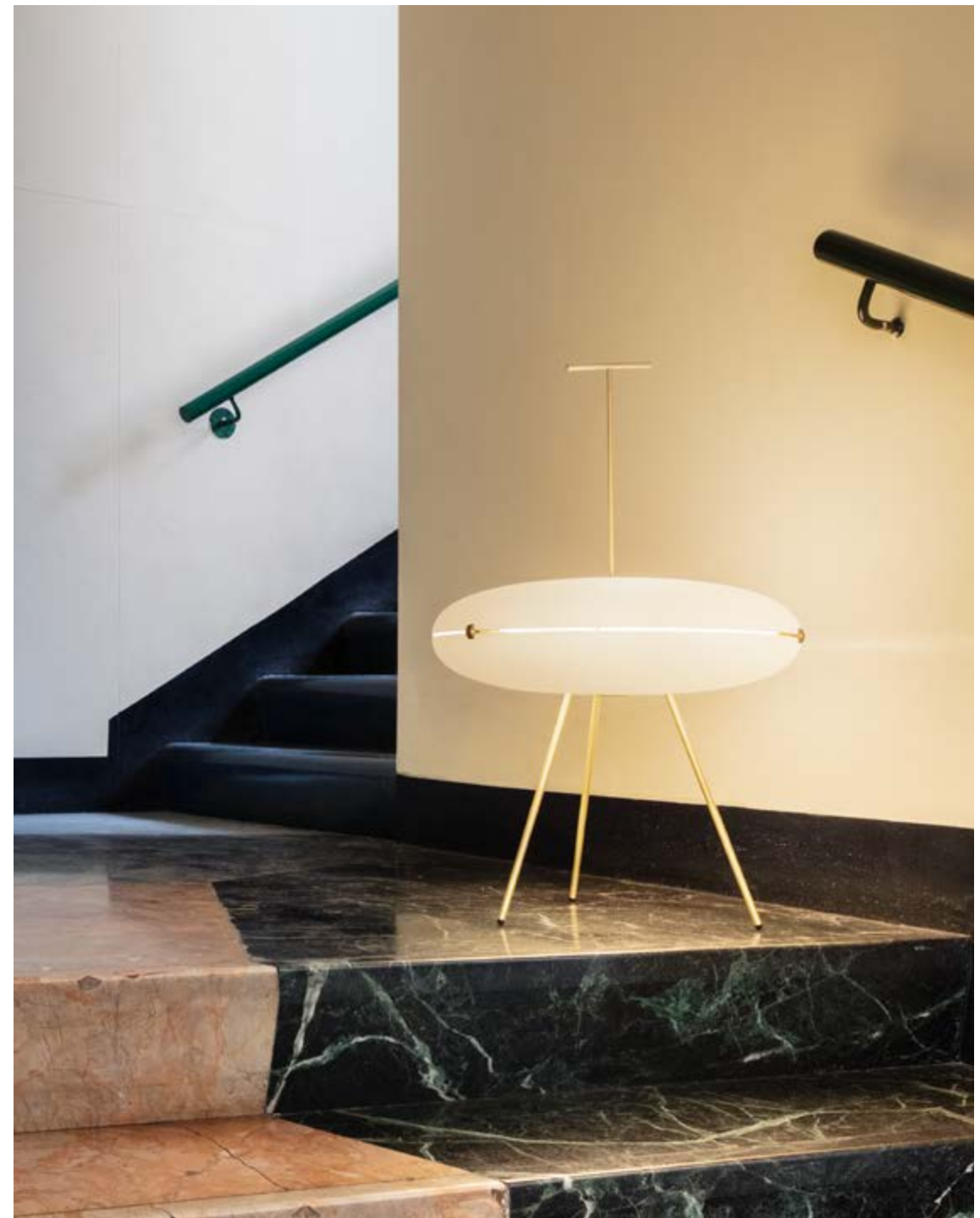

Luna Orizzontale

Type: floor lamp
Weight: 3,5 Kg
Bulbs: 3xLED E27/E26 806lm

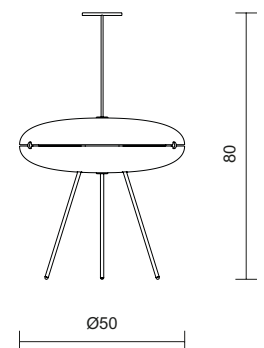



Luna Sospensione

Type: ceiling lamp
Weight: 3 Kg
Bulbs: 3xLED E27/E26 806lm

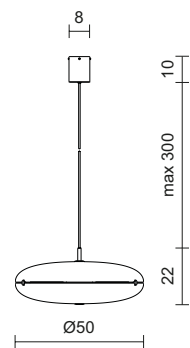



Luna Verticale

Type: floor lamp
Weight: 4 Kg
Bulbs: 4xLED E14/E12 470lm

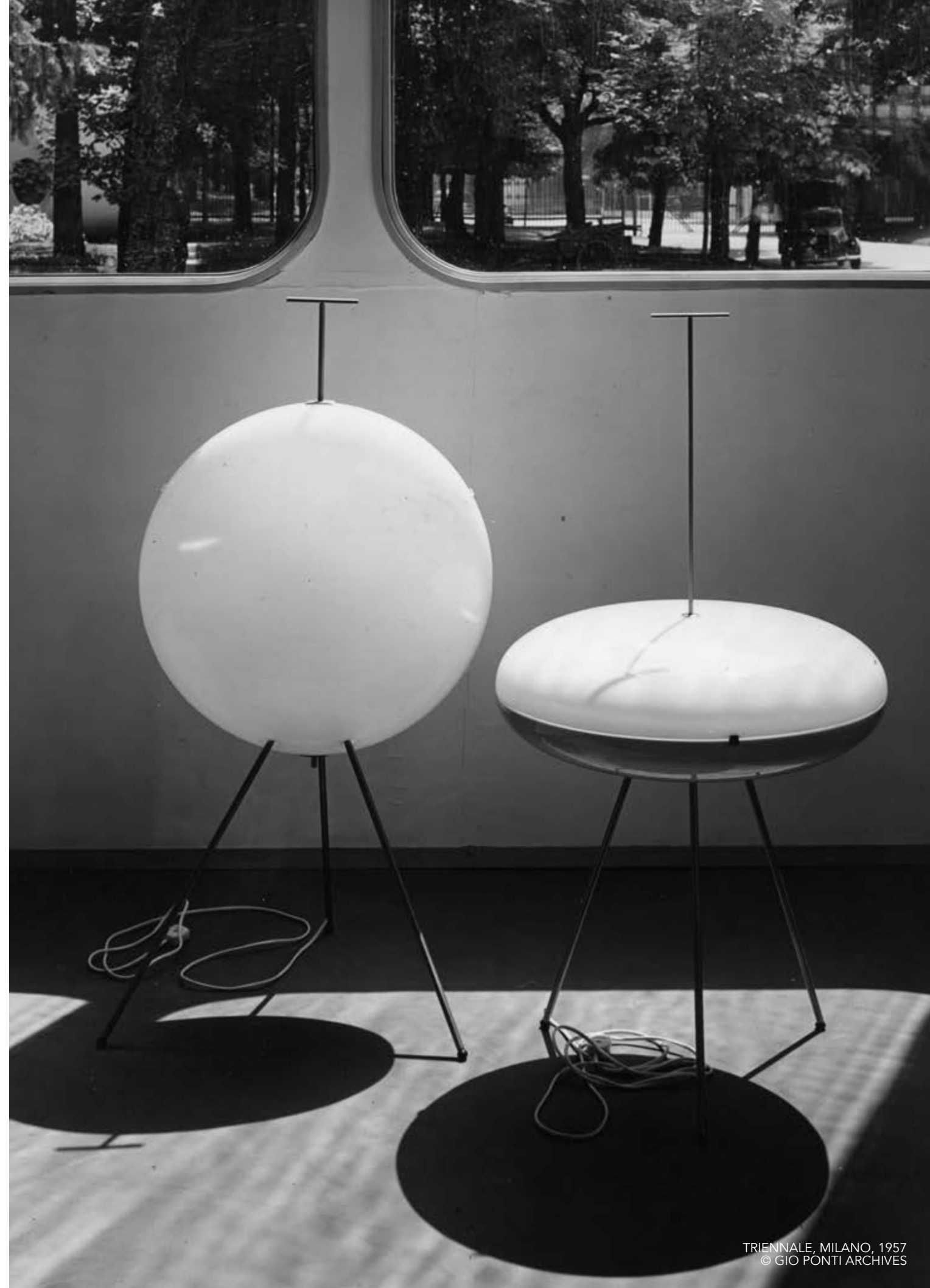
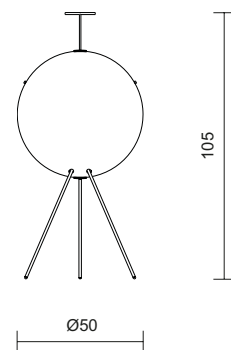

Netta

designed by Antonia Astori
2016

Details

Materials: iron / brass / glass
Insulation: class II / IP20
Bulbs: 1xLED E27/E26 806lm

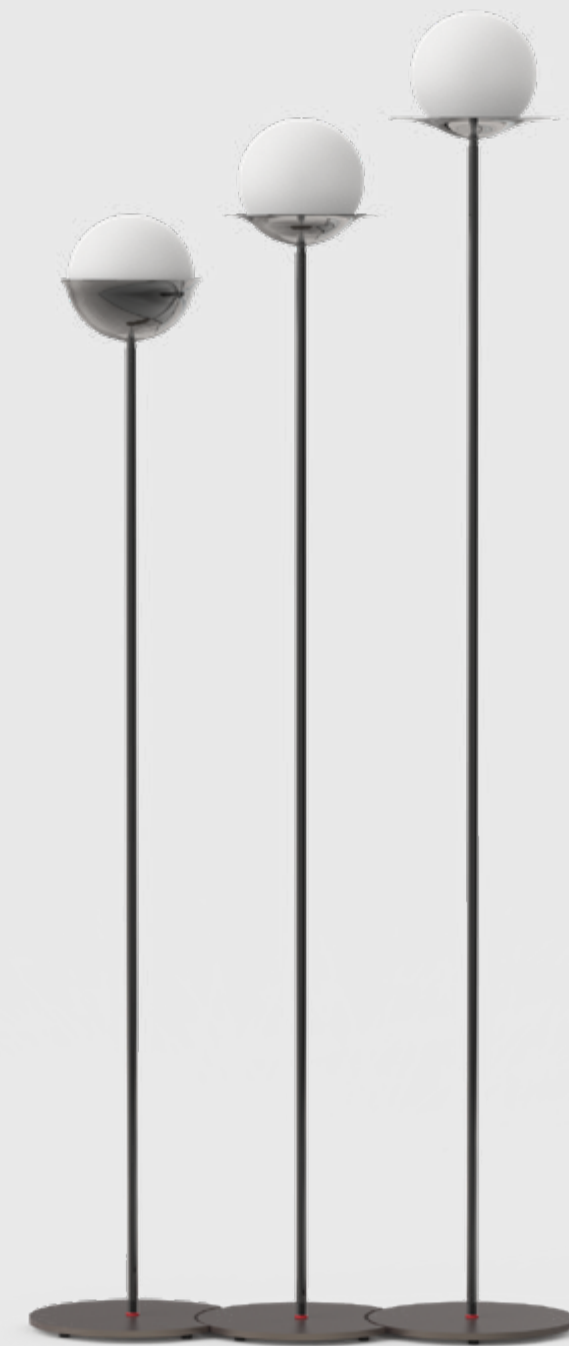

Models



Finishings

Body



Manganese grey base

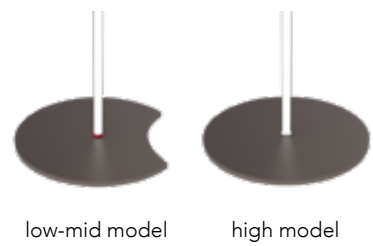

Shade



Netta Piantana

Type: floor lamp
Weight: 8 Kg

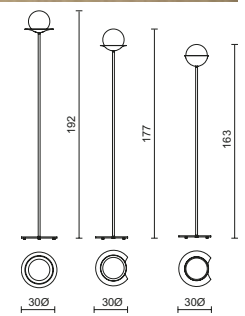

Netta Sospensione

Type: ceiling lamp
Weight: 2 Kg

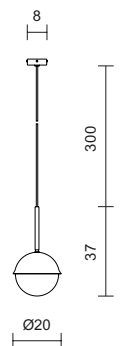

Olly

designed by Lorenza Bozzoli
2016



Details

Materials: brass / glass
Insulation: class II / IP20

Models

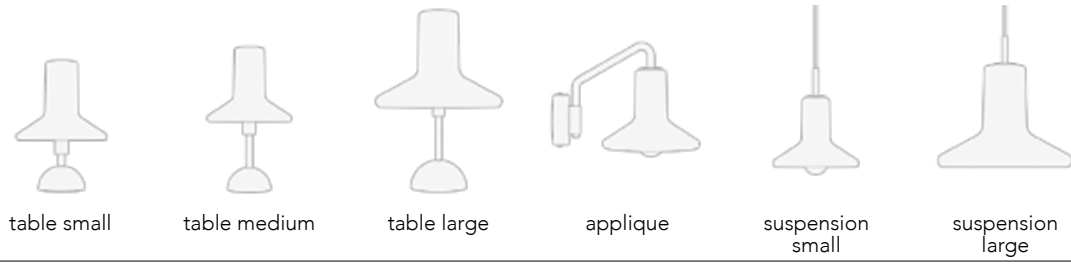

Finishings

Body



Shade



satin white glass



Olly Tavolo

Type: floor lamp
 Weight: 1,5 / 3,5 Kg
 Bulbs: 1xLED G9 400lm

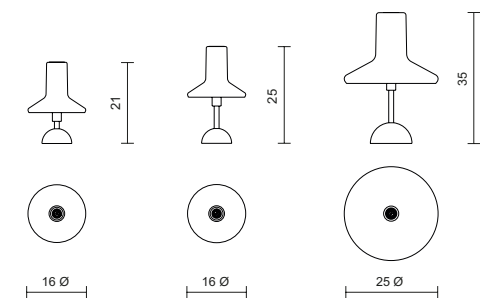



Olly Applique

Type: applique lamp
 Weight: 0,7 Kg
 Bulbs: 1xLED E14/E12 470lm

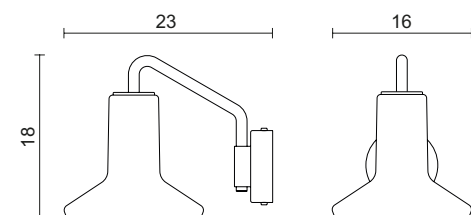

Olly Sospensione

Type: ceiling lamp
 Weight: 0,5 Kg
 Bulbs: 1xLED E14/E12 470lm

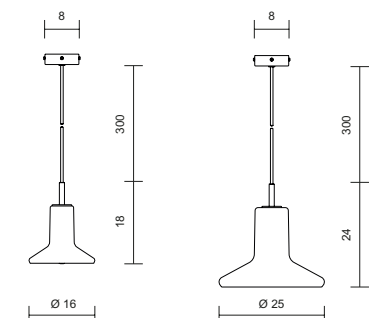

Orsola

designed by Lorenza Bozzoli
2016

Details

Type: table lamp
Materials: marble / brass / fabric
Weight: 8 kg
Insulation: class II / IP20
Bulbs: 3xLED E14/E12 470lm

Measurements

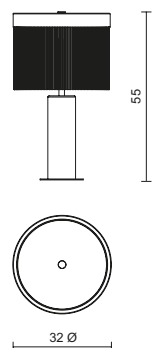

Finishings

Metallic structure



brass

black chrome

satin bronze

Marble base



carrara

marquinia

Fabric fringes



white



Pagoda Applique

designed by Ignazio Gardella
1958 / 2023

Details

Type: wall lamp
Materials: aluminum / iron
Weight: 12 Kg
Insulation: class II / IP20
Bulbs: 1xLED max 20W E27 2300lm

Measurements

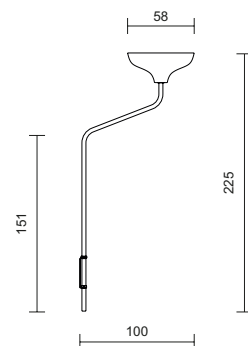

Finishings

Body

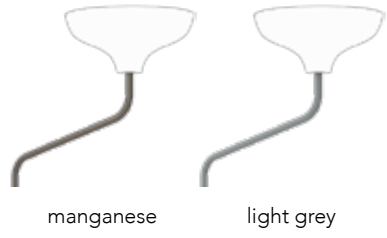

Shade



Pagoda Piantana

designed by Ignazio Gardella
1958 / 2023

Bold floor lamp built with strong materials and finishings, suitable for indoor and outdoor use.

Details

Type: outdoor-proof floor lamp
Materials: aluminum / iron / stone
Weight: 46 Kg
Insulation: class II / IP65
Bulbs: 1xLED max 20W E27 2300lm

Measurements

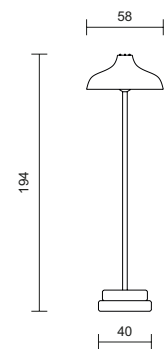

Finishings

Body and shade



terracotta

green-grey

Base



sandstone



Paolina

designed by Ignazio Gardella
1958 / 2021

Details

Type: ceiling lamp
Materials: plastic / iron / brass
Weight: 5 kg
Insulation: class I / IP20
Bulbs: 1xLED E27/E26 2300lm

Measurements

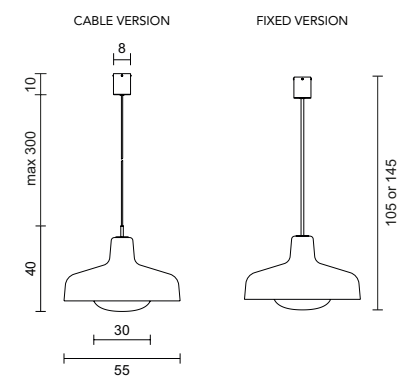

Finishings

Wall attachment

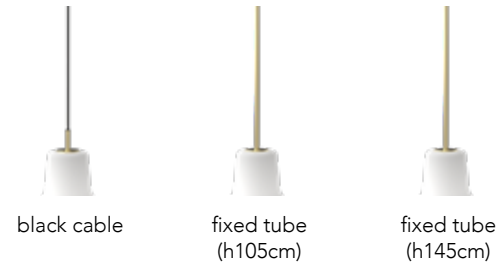

Accents



Polycarbonate shade



Prisma

designed by Ignazio Gardella
1960 / 2024

Details

Materials: brass / marble / fabric
Insulation: class II / IP20



Models

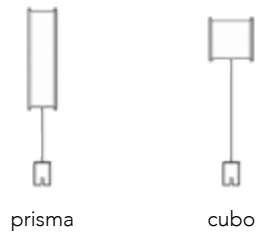

Finishings

Body

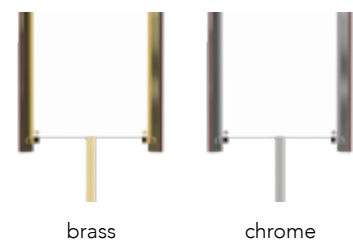

Base



Fabric shade



Prisma

Type: floor lamp
Weight: 30 Kg
Bulbs: 8xLED E27/E26 806lm

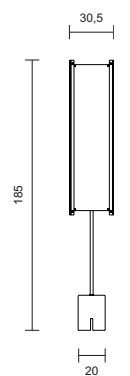



Cubo

Type: floor lamp
Weight: 25 Kg
Bulbs: 4xLED E27/E26 806lm

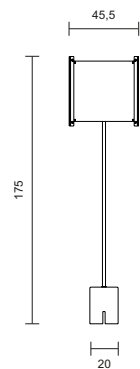

Siderea

designed by Alberto Rosselli
1969 / 2018

Details

Type: table lamp
Materials: iron / glass
Weight: 5 kg
Insulation: class II / IP20
Bulbs: 1xLED E27/E26 680lm with silver cap

Measurements

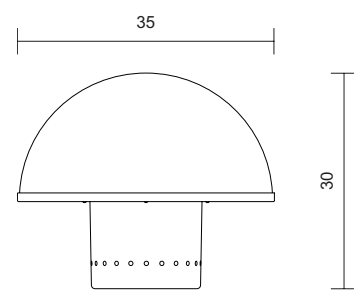

Finishings

Body



manganese

Glass shade



crystal



Varesina

designed by Matteo Nunziati
2021

Details

Type: ceiling lamp
Materials: brass / iron / aluminum
Insulation: class I / IP20



Models



small



medium



triple

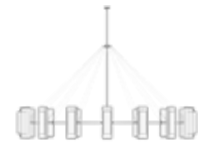

large

Finishings

Structure



brass

Shades

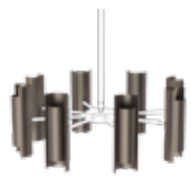

manganese

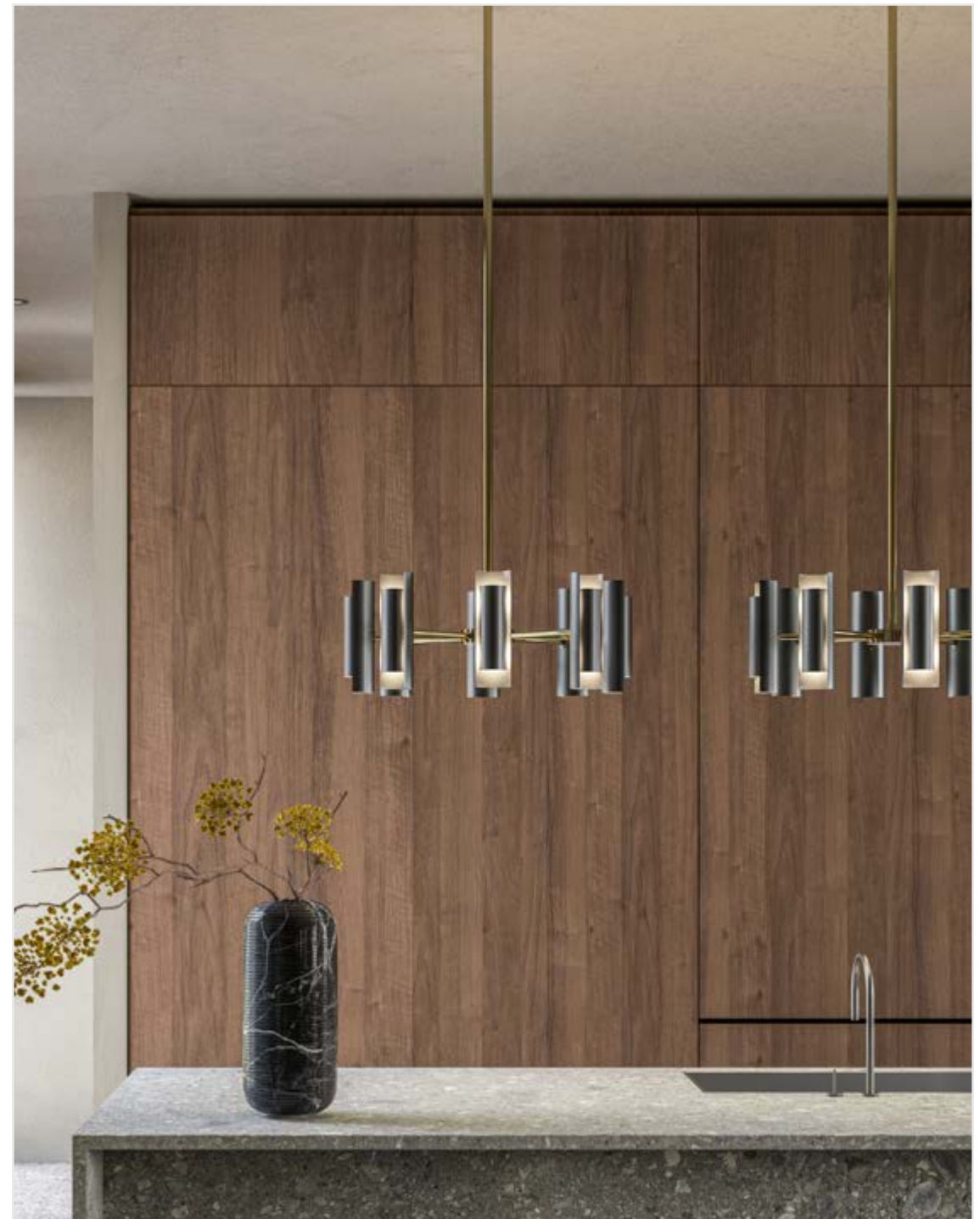

Varesina Small

Type: ceiling lamp
Weight: 10 Kg
Bulbs: 16xLED GU10 250lm

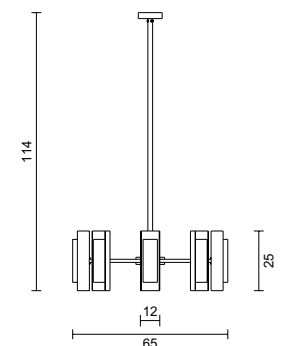



Varesina Medium

Type: ceiling lamp
 Weight: 18 Kg
 Bulbs: 32xLED GU10 250lm

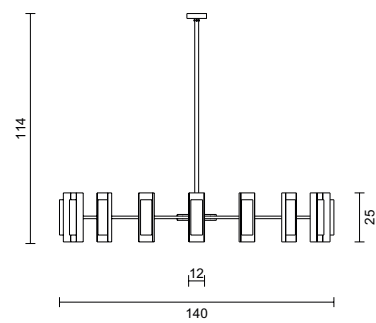

Varesina Triple

Type: ceiling lamp
 Weight: 36 Kg
 Bulbs: 64xLED GU19 250lm

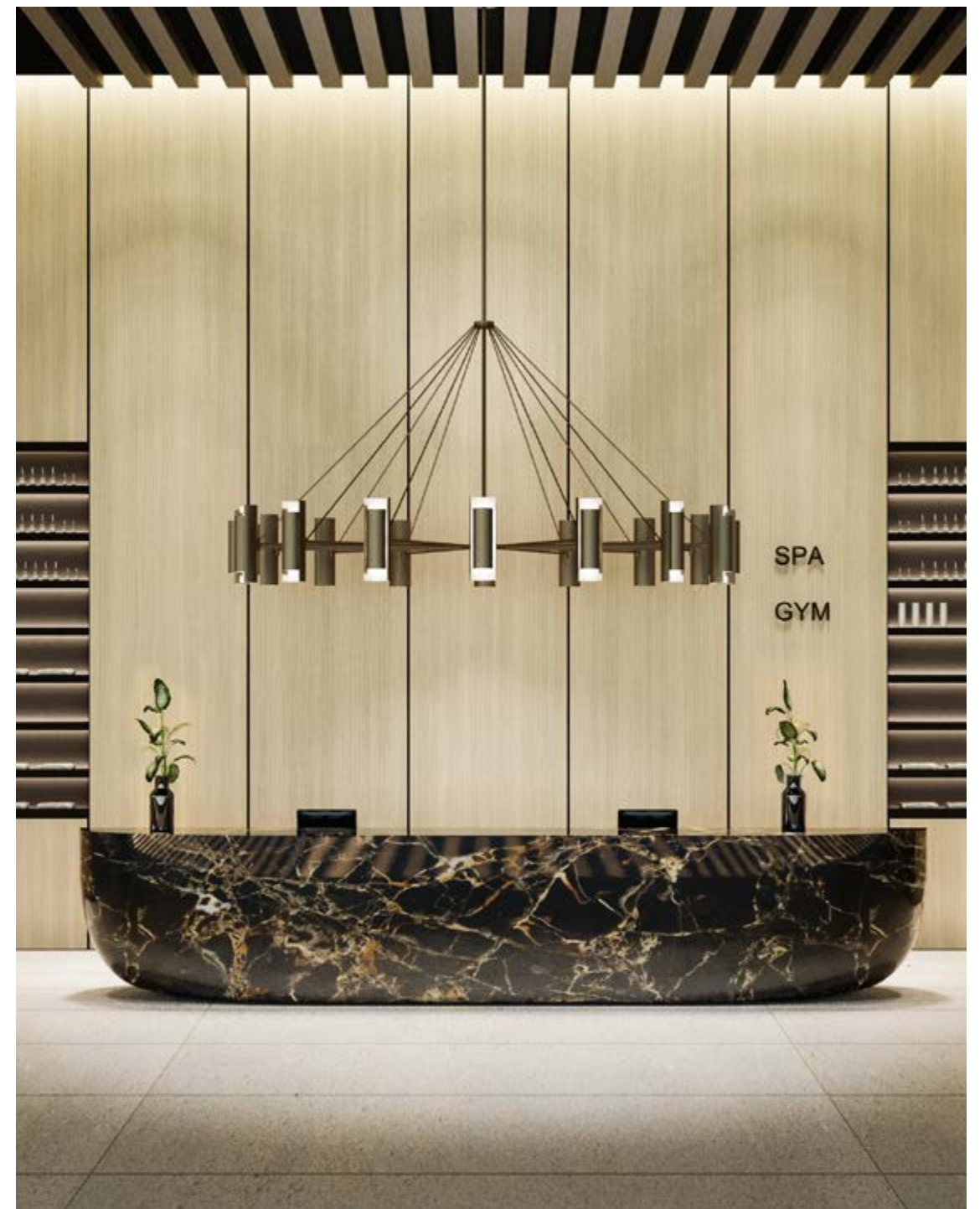
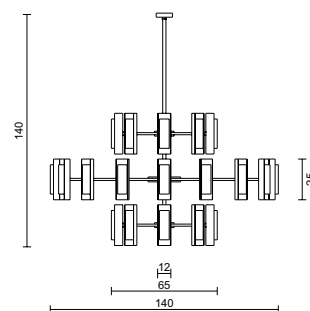

Varesina Large

Type: ceiling lamp
 Weight: 50 Kg
 Bulbs: 32xLED Custom COB

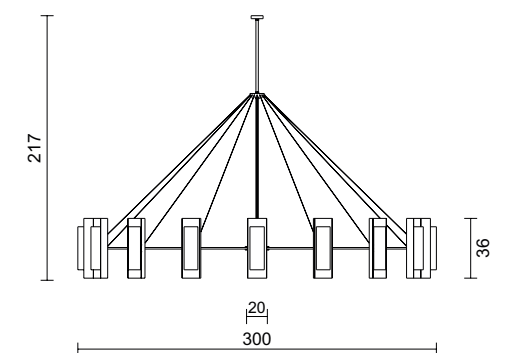

Vox

designed by Lorenza Bozzoli
2016



Finishings

Height



table low (40cm) table high (46cm) wall/ceiling

Shade



glossy white glossy black glossy green glossy blue satin brass brass satin bronze

Accents (table model)



brass chrome satin brass satin bronze

Marble base (table model)



carrara marquina emperador emperador dark portoro

Canopy (wall/ceiling model)



satin brass glossy white glossy black



Type: table lamp
 Materials: marble / brass or aluminum
 Weight: 2,5 Kg
 Insulation: class II / IP20
 Bulbs: 1xLED E27/E26 806lm

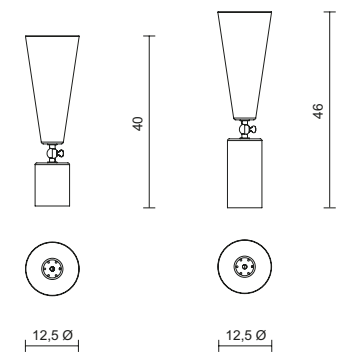



Type: wall/ceiling lamp
 Materials: brass or aluminum
 Weight: 0,5 Kg
 Insulation: class I / IP20
 Bulbs: 1xLED GU10 450lm

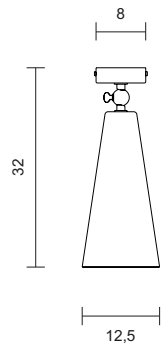

Wallie

designed by Lorenza Bozzoli
2014 / 2015

Details

Materials: brass / aluminum / iron / marble
Insulation: class II / IP20



Models



Finishings

Structure

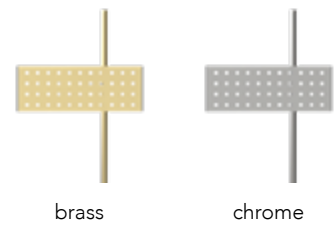

Lacquered plates



Wallie Tavolo

Type: table lamp
Weight: 6,5 Kg
Bulbs: 2xLED G9 400lm

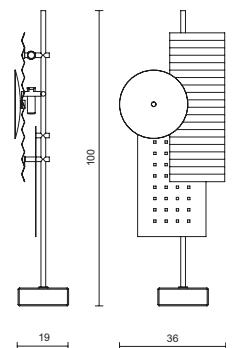



Wallie Piantana

Type: floor lamp
 Weight: 8,5 Kg
 Bulbs: 1xLED E27/E26 2300lm

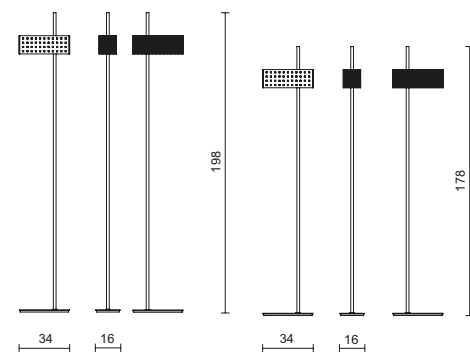

Wallie Applique

Type: wall lamp
 Weight: 3,4 Kg
 Bulbs: 2xLED G9 400lm

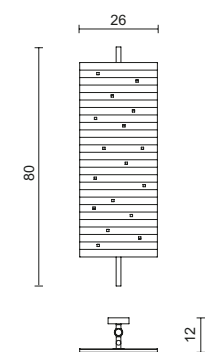



WHITE VERSION



Wallie Scultura

Type: wall lamp
 Weight: 23 Kg
 Bulbs: 5xLED G9 400lm

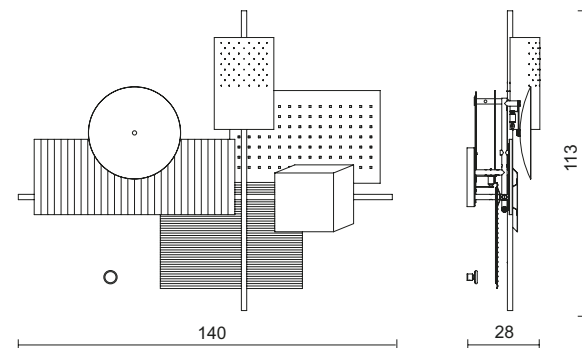

Wallie Chandelier

Type: ceiling lamp
 Weight: 12 Kg
 Bulbs: 1xLED E27/E26 806lm + 3xLED G9 400lm

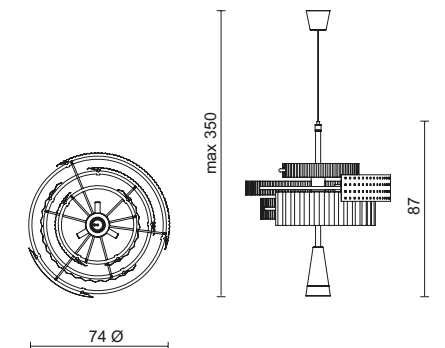



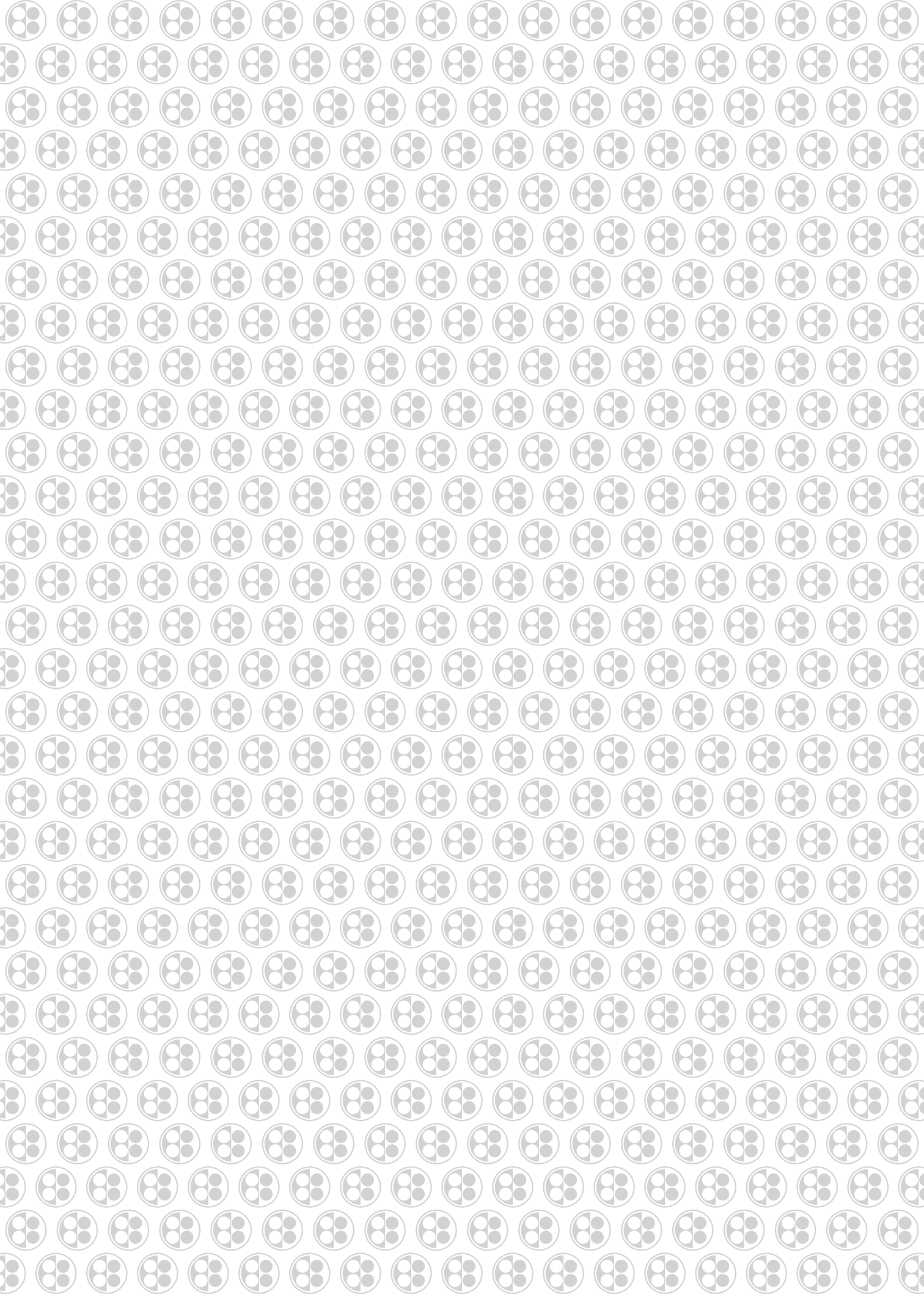

FURNITURE

Acca

designed by Alessandro Pasinelli
2021

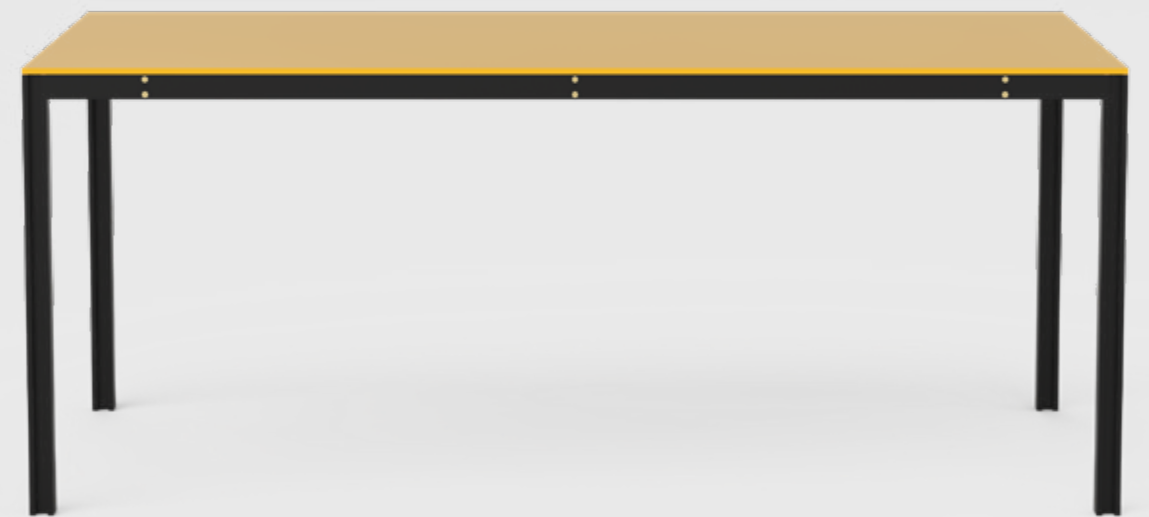

Details

Type: table
Materials: iron (base) / glass, wood or marble (top)

Models



table

coffee table

low table

Finishings

Body



matte black

satin gold

satin silver



black screws

gold screws

silver screws

Top

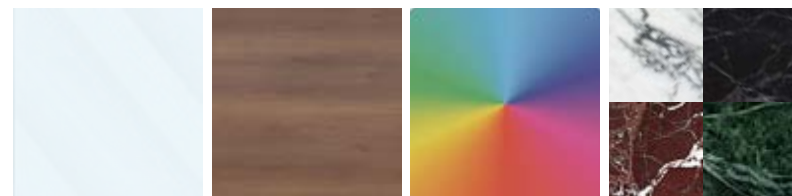

glass

satin walnut

lacquered wood

marble selection



Acca Table

Type: dining table / desk

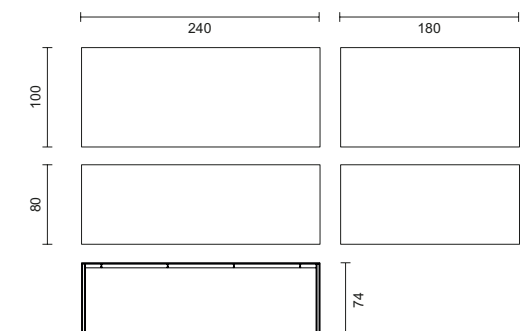



Acca Coffee Table

Type: coffee / side table

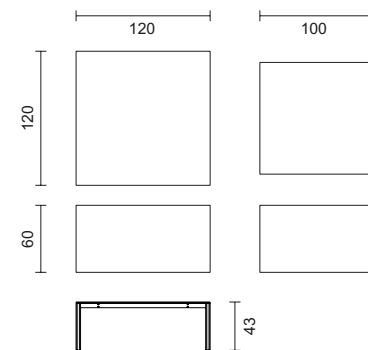

Acca Low Table

Type: coffee / side table

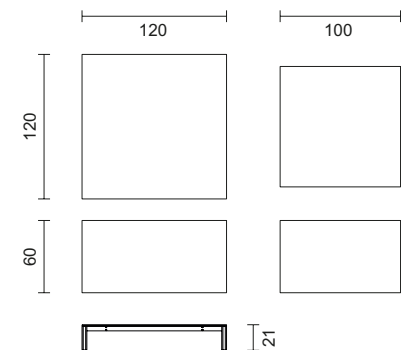

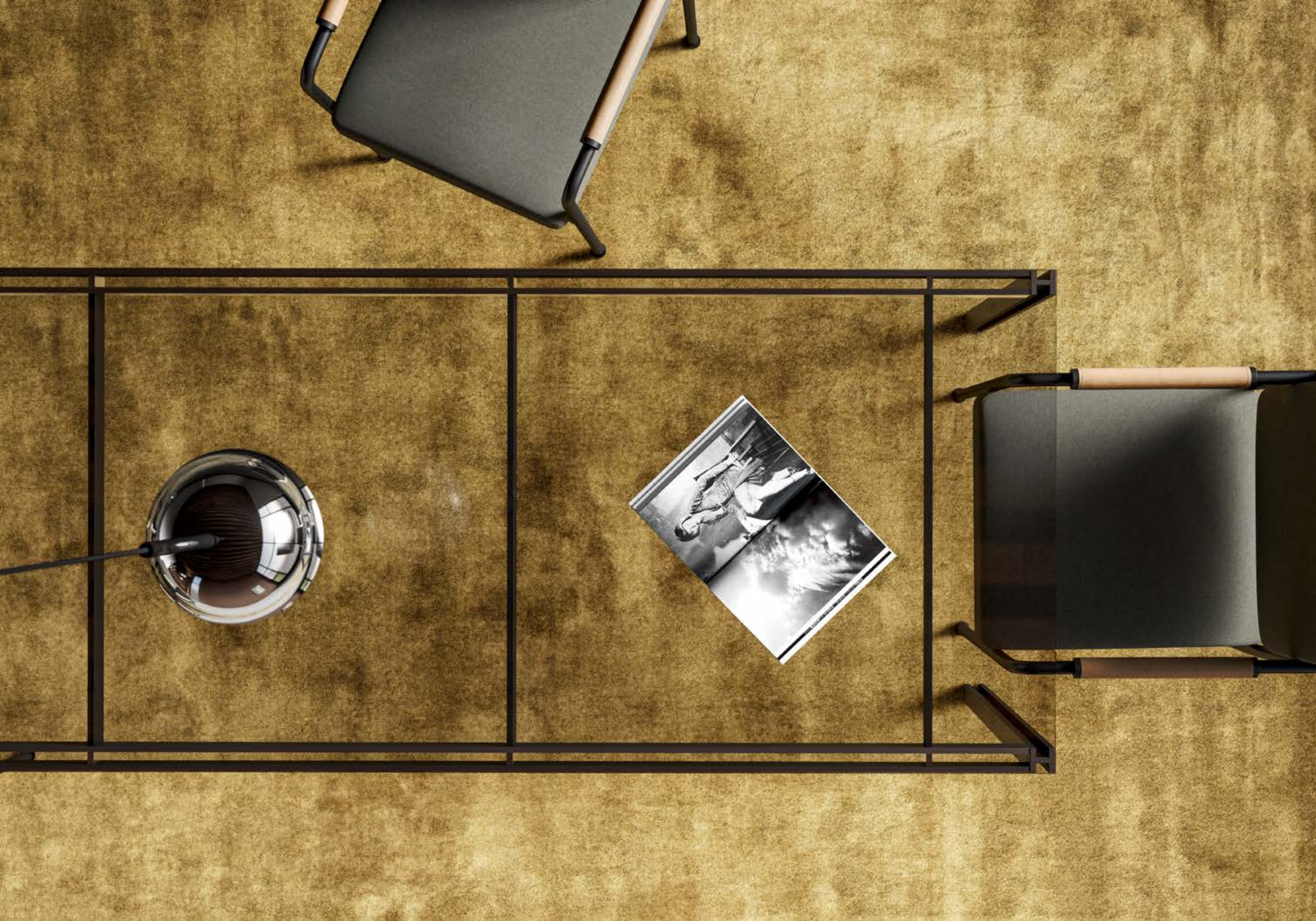

Angolo

designed by Corrado Corradi Dell'Acqua
1963 / 2018



Details

Type: armchair / pouf
Materials: wood / foam / fabric
Weight: 14 ~ 17 Kg

Measurements

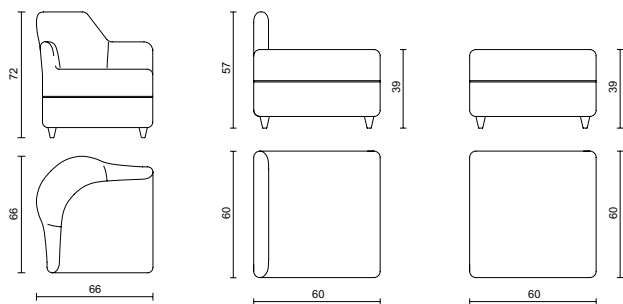

Models



armchair

pouf w/backrest

pouf

Upholstery



page 324







Domus

designed by Ignazio Gardella
1941 / 2024

Details

Type: console
Materials: wood / marble
Weight: 45 Kg

Measurements

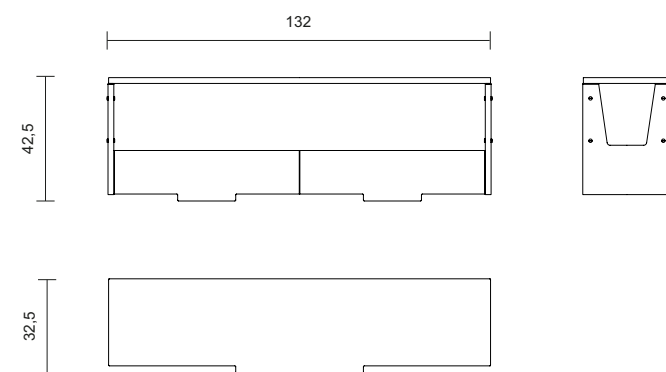

Finishings

Body



satin walnut

Top

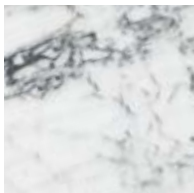

carrara marble





Fagiolo

designed by Atelier TATO, based on *Lido* project
2023

Details

Type: sofa
Materials: wood / foam / fabric
Weight: 26 Kg

Measurements

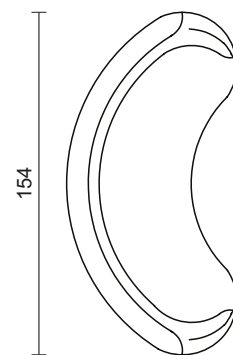
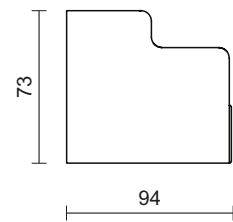



Libreria Modulare

designed by Ignazio Gardella
1955 / 2021



Details

Type: bookshelf
Materials: iron / brass / wood

Measurements

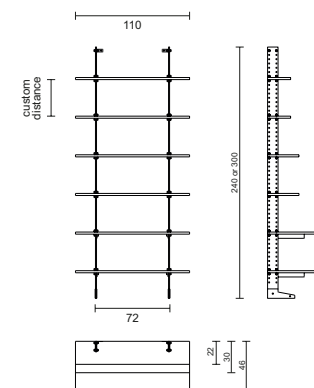

Models

Proposed combinations

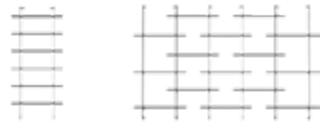

single module

triple module

Structure finishing

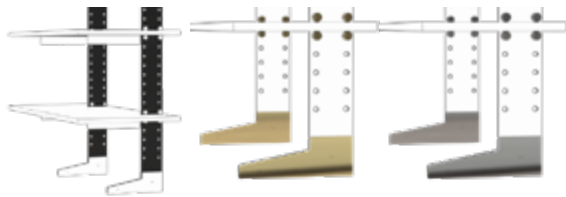

matte black

brass accents

chrome accents

Shelves depth

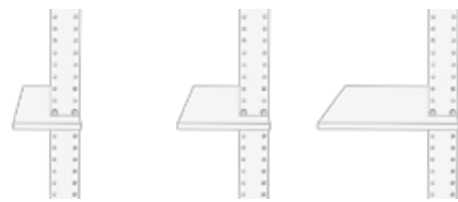

22cm

30cm

46cm

Shelves finishing

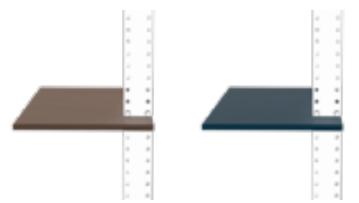

satin walnut

lacquered wood



Lido

designed by Ignazio Gardella
1965 / 2019

Details

Type: armchair / sofa
Materials: wood / foam / fabric
Weight: 18 / 25 Kg

Measurements

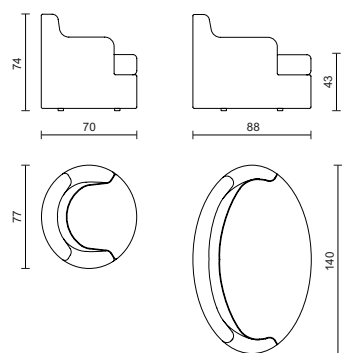

Models

Armchair



armchair



sofa

Upholstery



page 324

Options

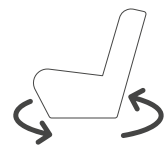

swivel movement





Monforte

designed by Alessandro Pasinelli
2021

Details

Type: lounge chair
Materials: iron / wood / foam / fabric
Weight: 8 Kg

Measurements

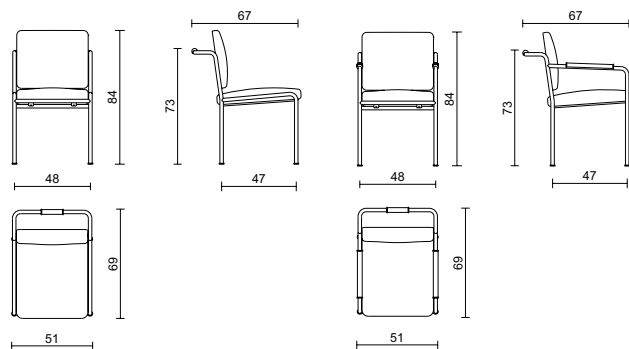

Finishings

Models



Body



Leather armrests

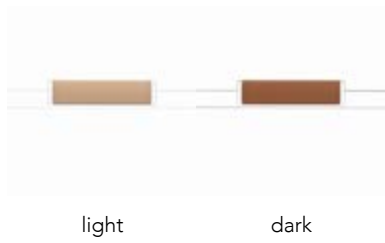

Feet and accents



Upholstery



page 324





Montecarlo

designed by Corrado Corradi Dell'Acqua
1959 / 2019

Details

Type: side table
Materials: brass / glass
Weight: 7 ~ 14 Kg

Measurements

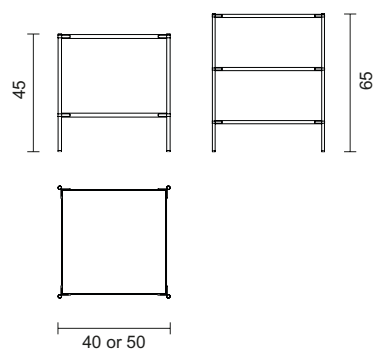

Finishings

Models



40x40cm
2 shelves

50x50cm
2 shelves

40x40cm
3 shelves

50x50cm
3 shelves

Finishing



brass

chrome



Piedi Regolabili

designed by Ignazio Gardella
1951 / 2018

Details

Type: table
Materials: iron / brass / wood

Measurements

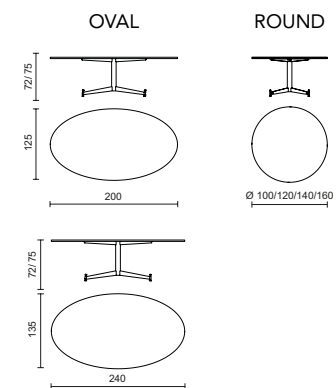

Models



Finishings

Base



Feet

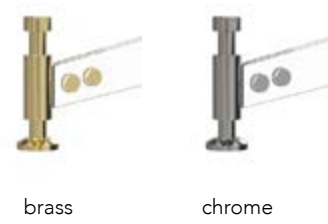

Top

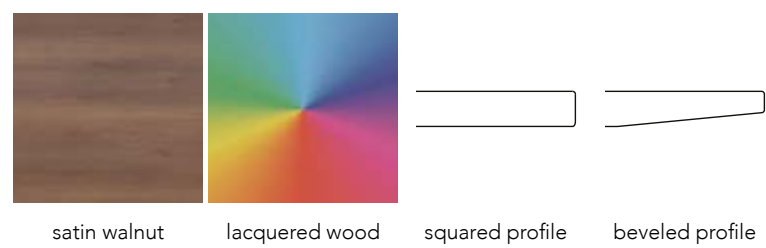



R63

designed by Ignazio Gardella
1963 / 2021

Details

Type: armchair
Materials: wood / foam / fabric

Measurements

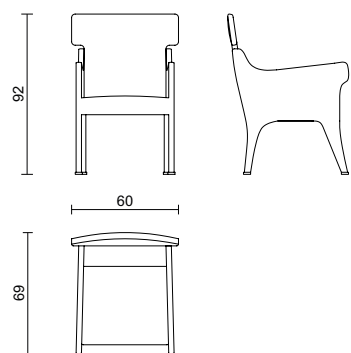



Sella

designed by Corrado Corradi Dell'Acqua
1961 / 2021

Details

Type: pouf
Materials: wood / foam / fabric

Measurements

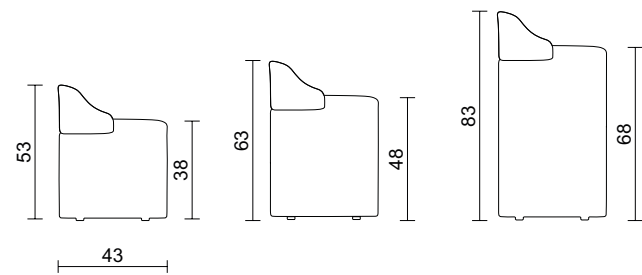

Models

Seat height



Upholstery



page 324

Options

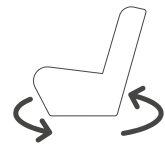

swivel movement

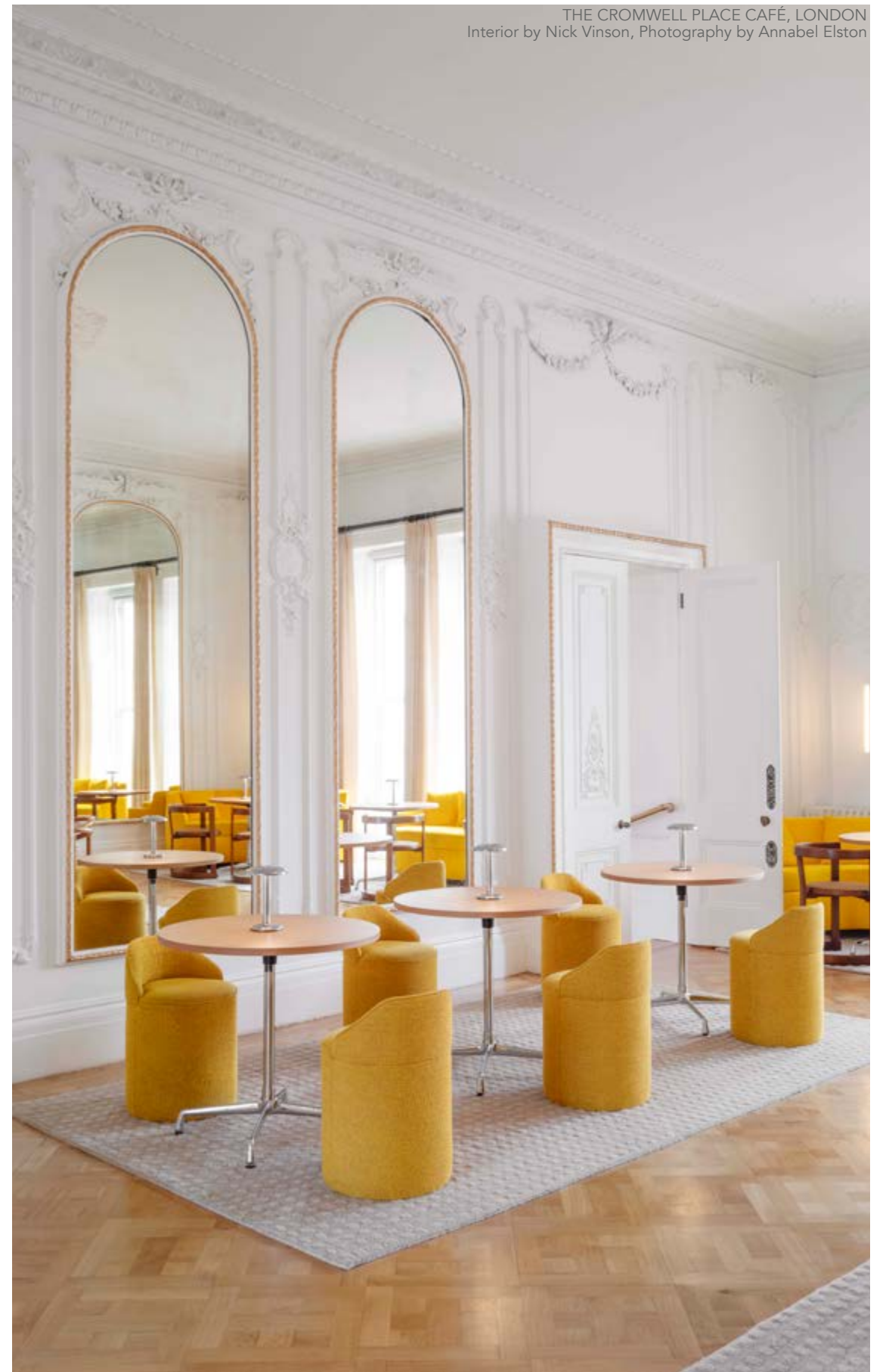

Stand

designed by Ignazio Gardella
1952 / 2021

Details

Type: side table
Materials: marble / brass / wood

Measurements

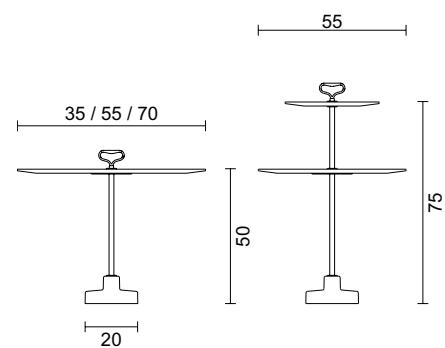

Finishings

Models

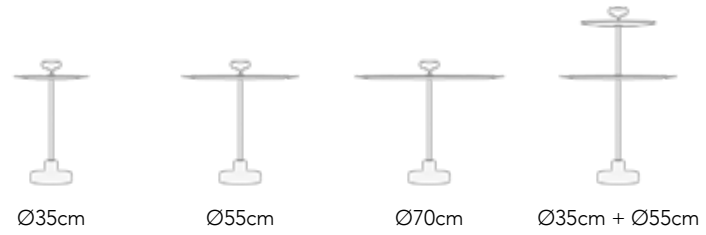

Tabletop



Body and handle

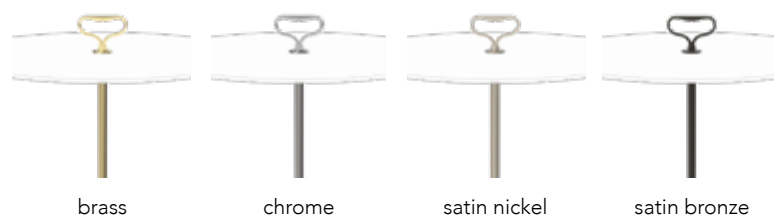

Marble base





Tre Maniglie

designed by Corrado Corradi Dell'Acqua
1953 / 2021

Details

Type: trolley
Materials: brass / formica wood or glass

Measurements

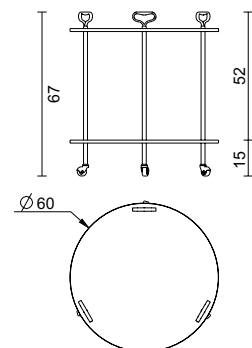

Finishings

Tops



formica wood
(black)

lacquered
(any color)

glass

Body and handles



brass

chrome



Trecentosessanta

designed by Eugenio Gerli
1958 / 2017

Details

Type: lounge armchair
Materials: wood / foam / fabric
Weight: 9 Kg

Measurements

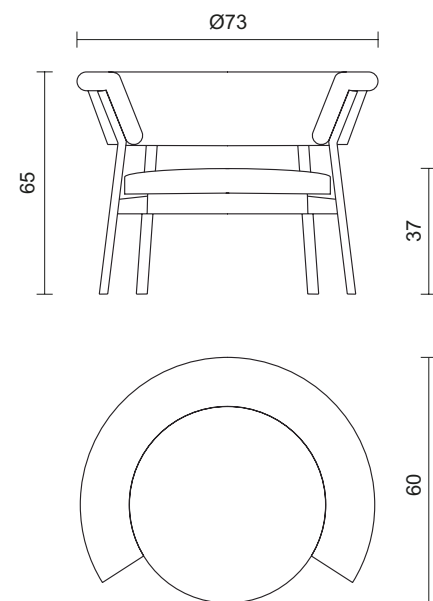

Structure



brown durmast

black durmast

Upholstery



page 324

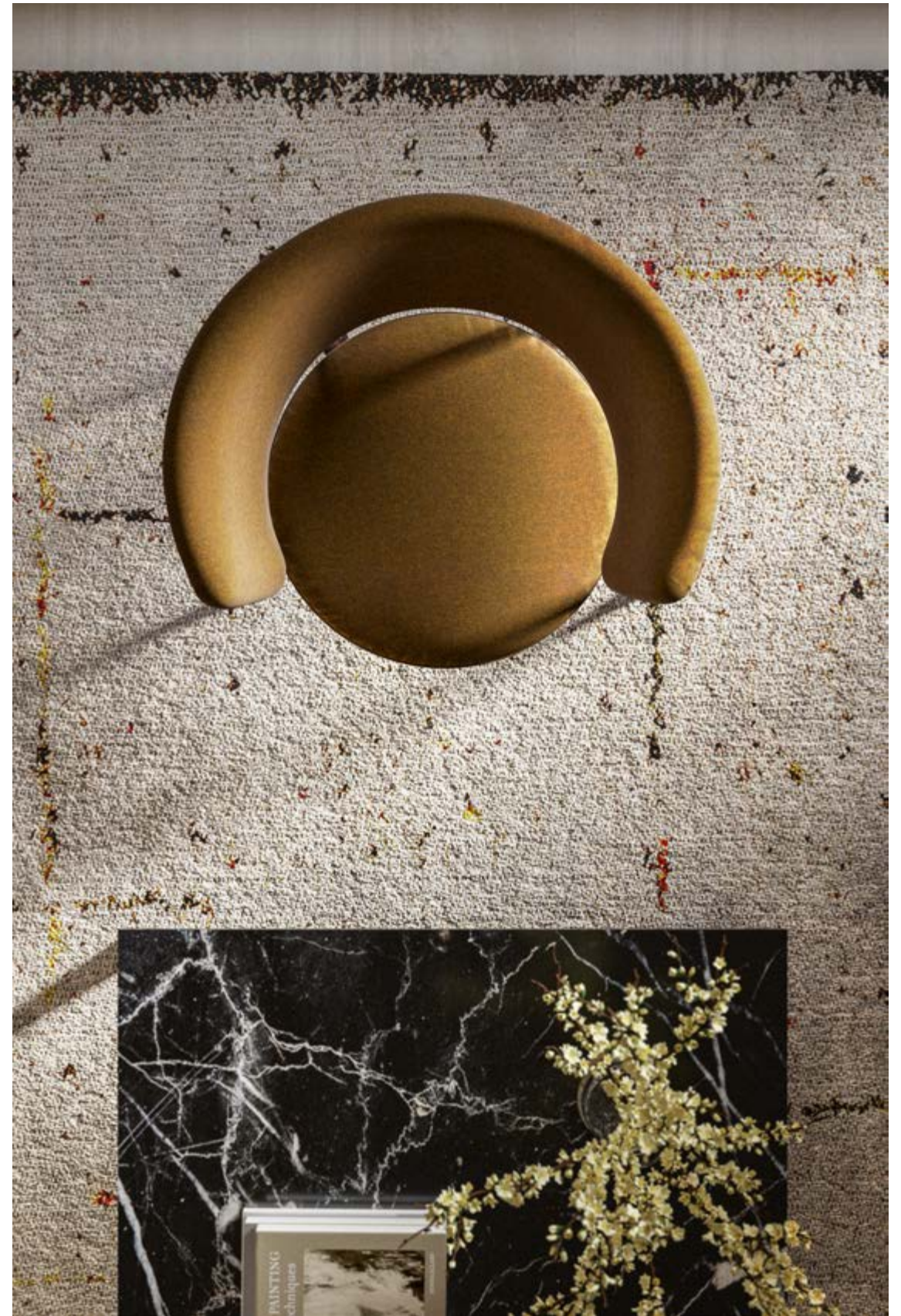



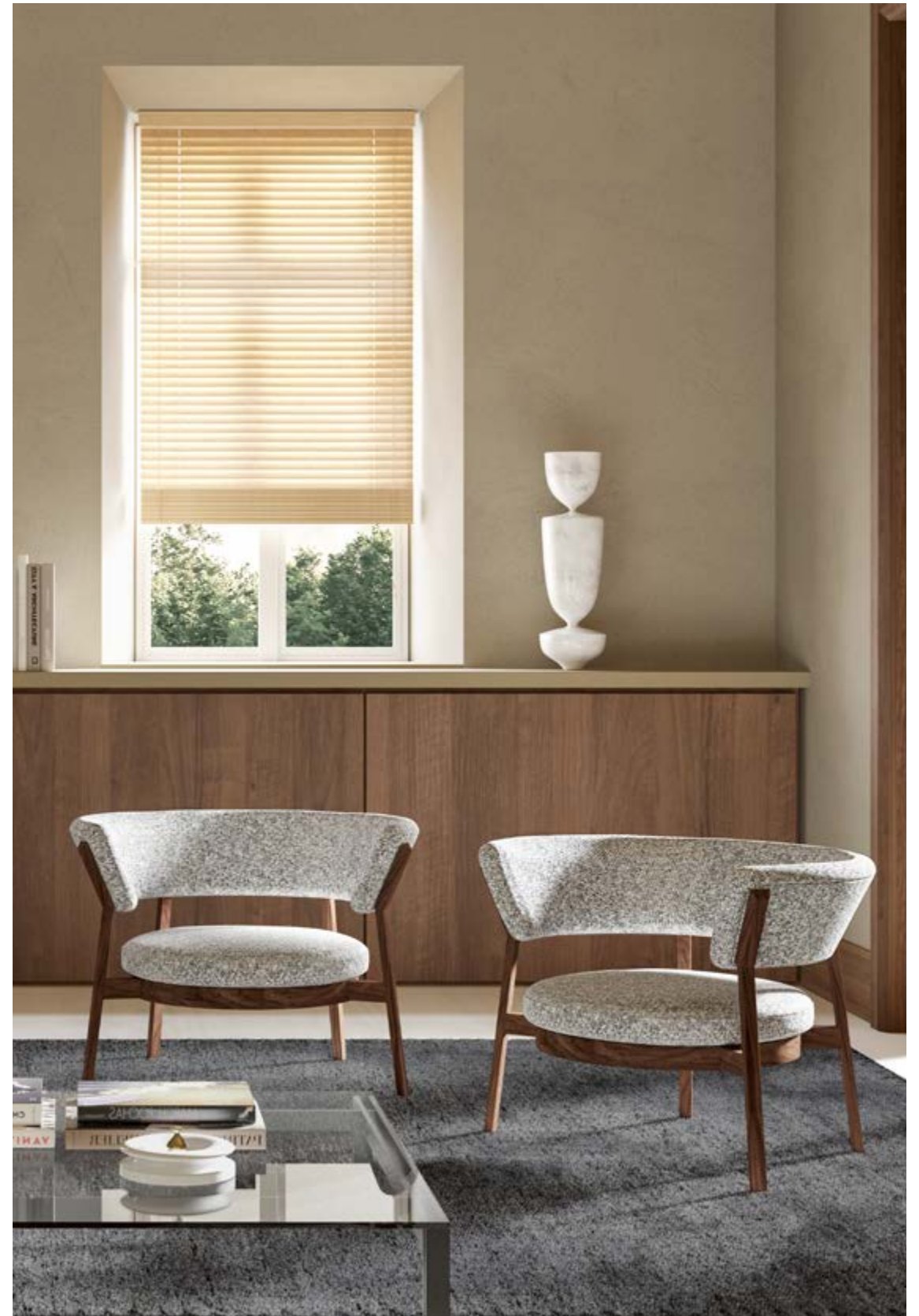

Truno

designed by Corrado Corradi Dell'Acqua
1960 / 2021

Details

Type: sofa
Materials: wood / foam / fabric

Measurements

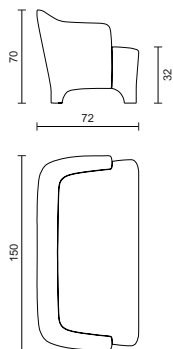



Zoagli

designed by Studio2046
2023

*Broad collection of metallic furniture,
treated with outdoor-proof finishings,
but also suitable for indoor use.*



Details

Type: outdoor & indoor collection
Materials: iron / marble / foam and fabric

Models

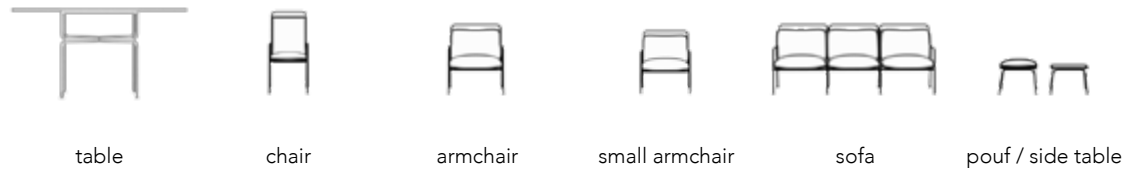

Finishings

Structure

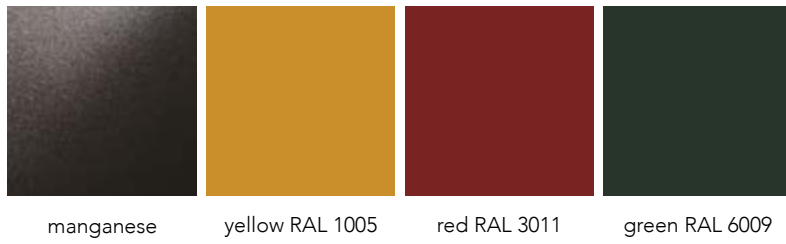

Marble tabletop

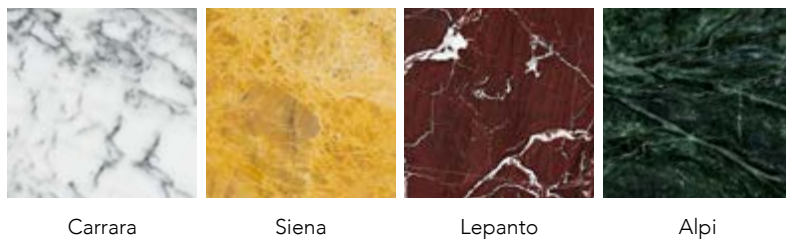

Upholstery for seats: *Farniente* by Dedar (water repellent)



Upholstery for seats: *Patio* by Kvadrat (water draining)

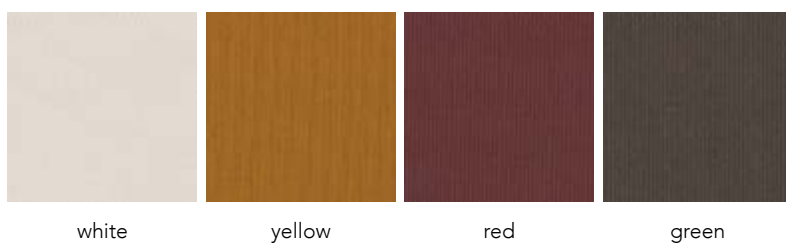

Table

Type: outdoor-proof dining table

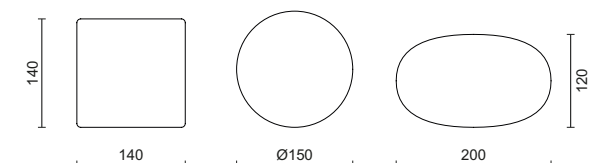

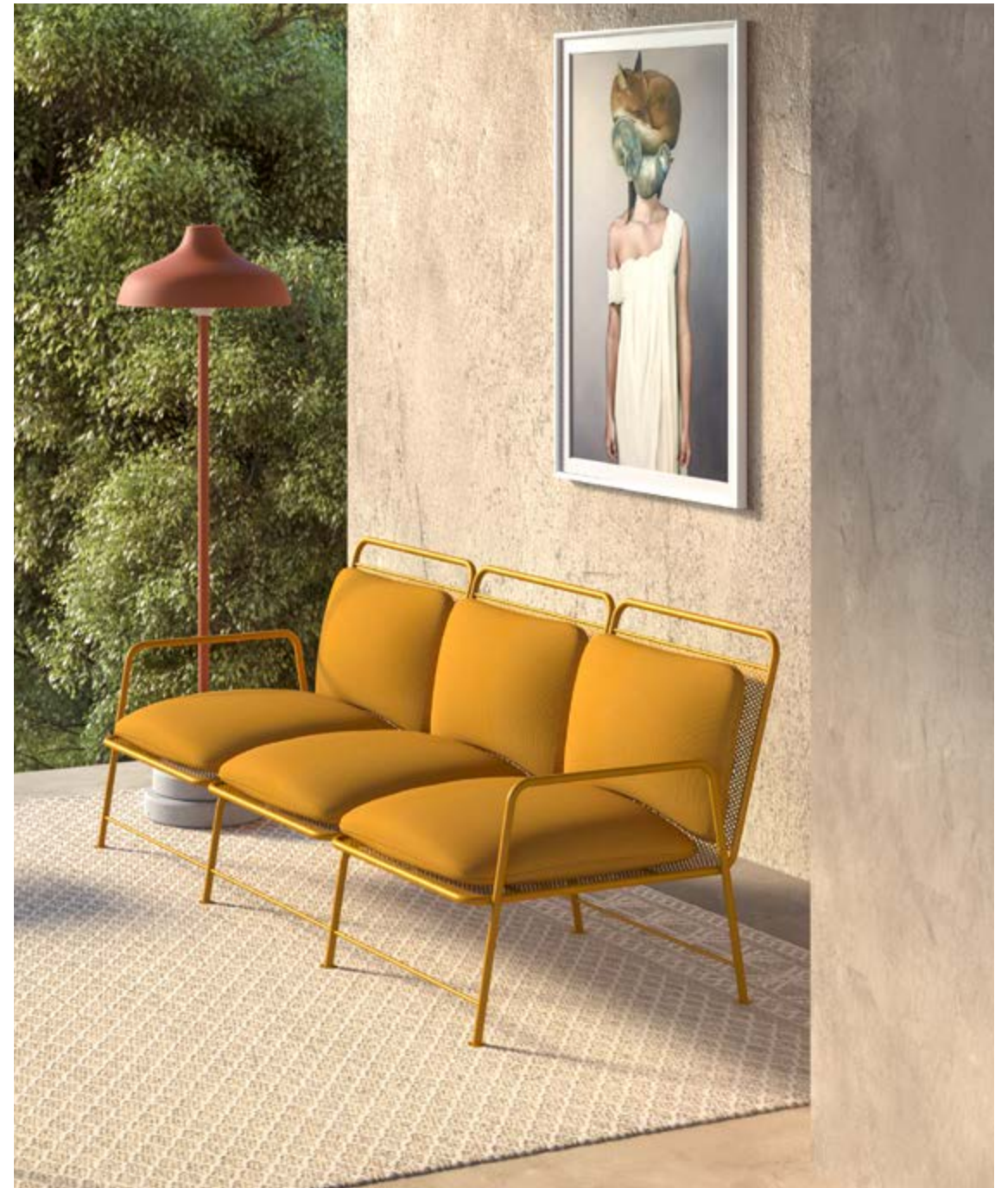

Chair

Type: outdoor-proof dining chair

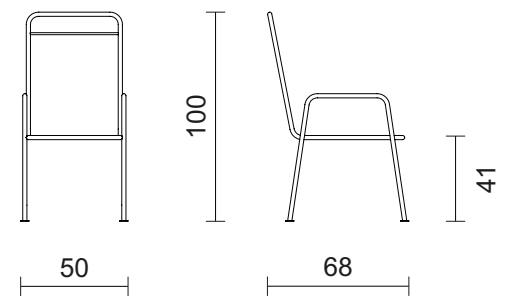

Sofa

Type: outdoor-proof sofa

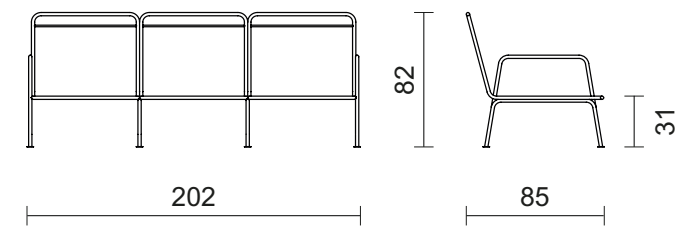



Armchair

Type: outdoor-proof armchair

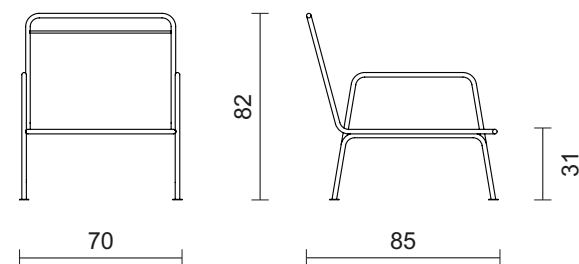

Small armchair

Type: outdoor-proof armchair

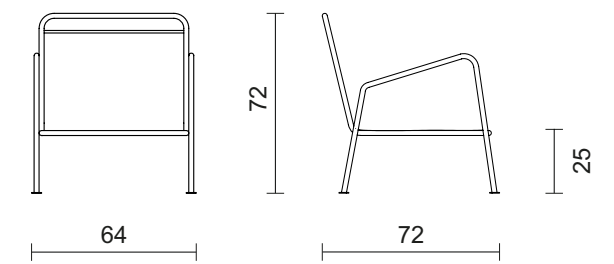

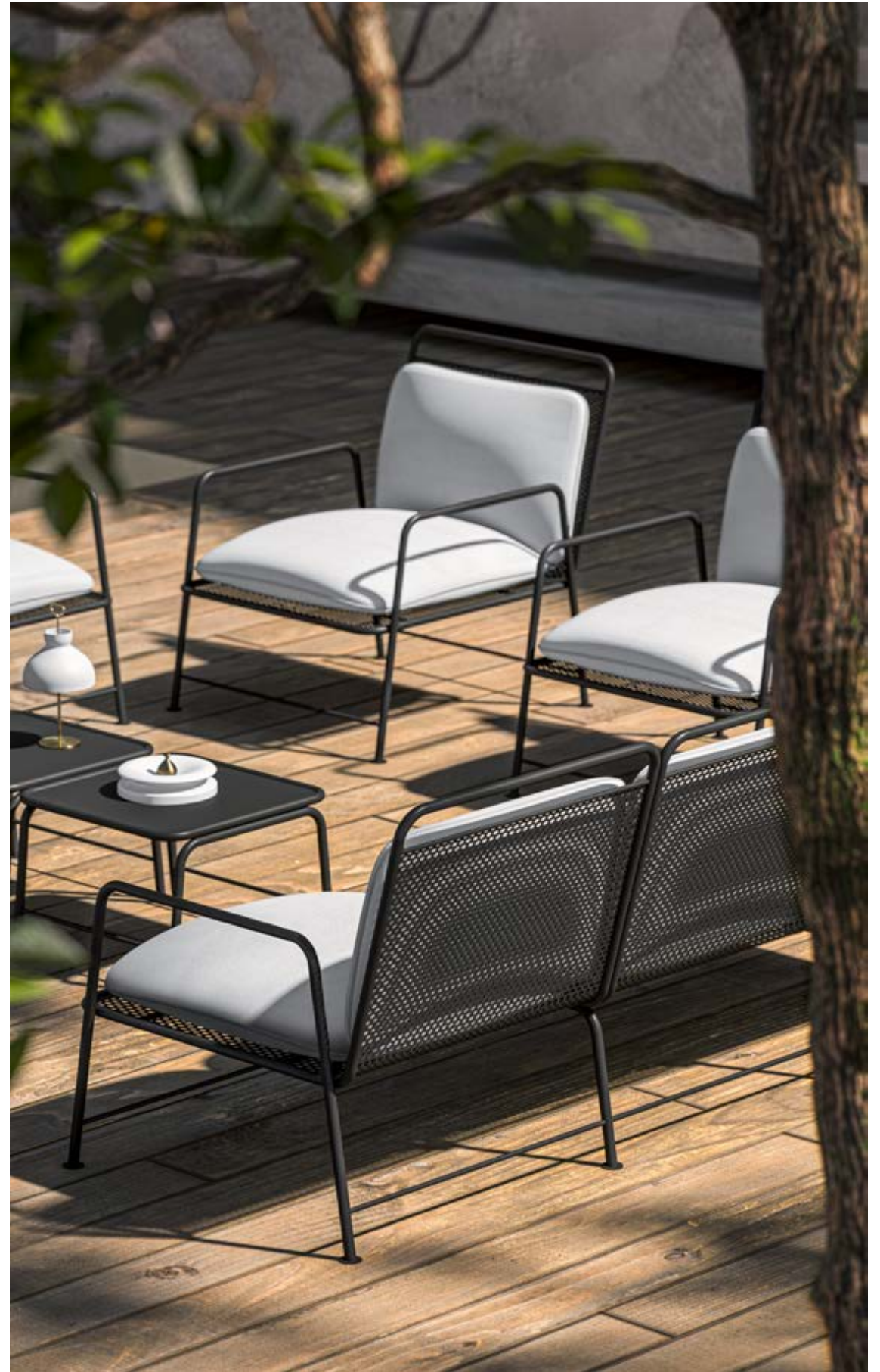

Pouf

Type: outdoor-proof pouf / side table

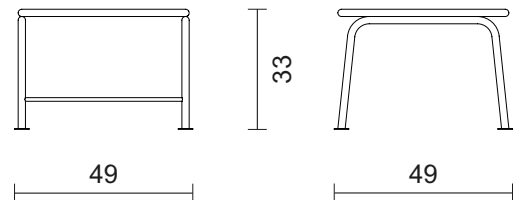



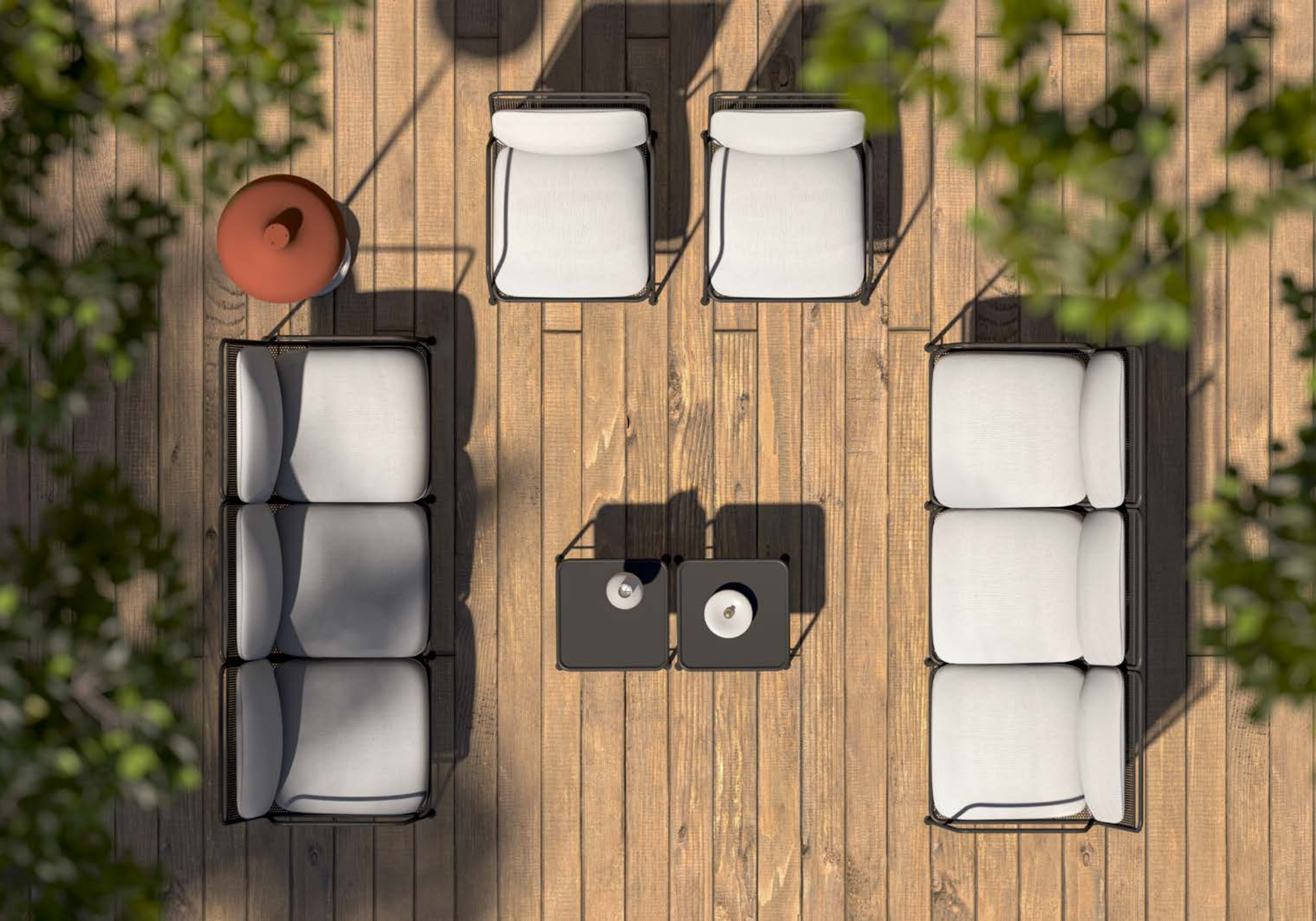



Products



Domus console
TDO600-1538
walnut/Carrara marble



Lido armchair
TFA600-3800
custom leather



Stand side table 55cm
TST610-0916-G
brass/black marble/glossy top



Coppa Aperta Applique lamp
TCA200-0924
brass/glossy black



Products



Besana lamp
TBS100-3565
matte black



Monforte chair
TSM600-3500
matte black/custom fabric



Piedi Regolabili oval table
TPR603-0935
brass feet/glossy top



Pestello ashtray
TCC980-1511
Sivec marble/brass



Products



Domus console
TDO600-1538
walnut/Carrara marble



Fagiolo sofa
TFA600-3800
custom fabric



Stand side table 55cm
TST610-0916-S
brass/black marble/satin top



Prisma lamp
TPS400-0915
brass/Carrara marble



Products



Prisma Cubo lamp
TPS410-0915
brass/Carrara marble



Piedi Regolabili round table
TPR614-0935
brass feet/satin top



Sella pouf medium
TSE610-38CC
Rubelli Nexus



Modulare bookshelf
TLM600-0935
custom modules/brass/h240cm



Ampolla Alta vase
TCC942-3132
platinum



Products



Besana lamp
TBS100-3565
matte black



Monforte chair
TSM600-13CC
gold/Rubelli Scott



Monforte lounge chair
TSM610-35DD
black/Kvadrat Hero Heather



Piedi Regolabili oval table
TPR603-0935
brass feet/satin walnut top



Domus console
TDC600-1538
walnut/Carrara marble



Arezano lamp
TAR310-0940
brass/white glass



Tre Maniglie trolley
T3M600-0938
brass/formica wood



Products



Alzabile lamp
TAL400-1523
glossy white/brass/Carrara marble



Fagiolo sofa
TFA600-38BB
Kvadrat Vidar4



Pagoda Applique lamp
TPG200-2322
manganese/glossy white



Trecentosessanta armchair
TTS600-38AA
durmast/Rubelli Rattoppato



Acca low table
TTH620-3535
black base/Carrara marble top



Products



Prisma lamp
TPS400-0915
brass/Carrara marble



Sella pouf medium
TSE610-38BB
Dedar Tiger Beat



Stand side table 70cm
TST620-0916-W
brass/black marble/walnut top



Modulare bookshelf
TLM600-0935
custom module/brass/h240cm



R63 armchair
T63600-09BB
Kvadrat Divina3/brass



Leina lamp
TLE310-1665
black marble



Products



Pagoda Applique lamp
TPG200-2322
manganese/glossy white



Trecentosessanta armchair
TTS600-3800
durmast/custom fabric



Acca low table
TTH620-2121
silver base/black marble top



Stand side table 55cm
TST610-0116-G
chrome/black marble/glossy top



Products



Doppio Vetro Applique lamp
TDV200-0140
chrome



Trecentosessanta armchair
TTS600-3800
durmast/custom fabric



Acca low table
TTH620-2121
silver base/glass top



Fagiolo sofa
TFA600-3800
custom fabric



Products



Doppio Vetro Sospensione lamp
TDV110-0940
brass



Monforte chair
TSM600-3500
matte black/custom fabric



Piedi Regolabili oval table
TPR603-0935
brass feet/satin walnut top



Products



Alzabile lamp
TAL400-1501
chrome/Carrara marble



Fagiolo sofa
TFA600-3800
custom fabric



Stand side table 55cm
TST610-0115-S
chrome/Carrara marble/satin top



Modulare bookshelf
TLM600-0935
custom module/brass/h240cm



Products



Coppa Aperta Piantana lamp
TCA400-1609
brass/Marquinia marble



Jil lamp
TJL300-1315
satin brass/Carrara marble



Acca low table
TTH621-0606
gold/walnut top



Montecarlo side table
TMO610-0909
brass



R63 armchair
T63600-0960
custom fabric/brass



Truno sofa
TRU600-38BB
Kvadrat Divina3



Pestello ashtray
TCC980-1511
Sivec marble/brass



Products



Lea lamp
TLE300-5040
Portoro marble/white glass



Paolina lamp
TPL110-0965
brass/satin white polycarbonate



Monforte lounge chair
TSM610-3500
matte black/custom fabric



Piedi Regolabili oval table
TPR630-0135
black/chrome feet/satin top



Products



Coppa Aperta Applique lamp
TCA200-0924
brass/glossy black



Icones Piantana lamp
TIC400-1365
satin brass/satin nickel



Tre Maniglie trolley
T3M600-0938
brass/formica wood



R63 armchair
T63600-09BB
Kvadrat Divina3/brass



Products



De-Lux B4 lamp
TDB440-0665
gold/matte white shade



Angolo armchair & poufs
TPA600-38BB
Kvadrat Divina3



Lido armchair
TLI600-3800
custom fabric



Stand 70 table
TST620-0916-W
brass/marquina marble/walnut



Stand Double table
TST630-0915-S
brass/carrara marble/satin lacquer



Products



Alzabile lamp
TAL400-1609
brass/marquimia marble



Lido sofa
TLI601-38BB
Kvadrat Divina3



Montecarlo side table
TMO610-0909
brass



Rocchetto vase
TCC932-3231
dark blue/platinum



Products



Netta Sospensione lamp
TNE100-3401
black chrome



Acca dining table
TTH600-3535
matte black base/glass top



Monforte lounge chair
TSM610-35BB
matte black/Kvadrat Divina3



Products



Luna Sospensione lamp
TLU100-0968
brass/glossy white and orange



Olly Tavolo Medium lamp
TOL310-1341
satin brass/satin white glass



Acca dining table
TTH600-3535
matte black base/custom top



Modulare bookshelf
TLM600-0935
single module/brass/h240cm



Monforte lounge chair
TSM610-3500
matte black/custom fabric



Pestello ashtray
TCC980-1511
Sivec marble/brass



Products



Biba Tavolo lamp
TBI300-3540
matte black



De-Lux B4 lamp
TDB440-3565
matte black/matte white shade



Acca coffee table
TTH611-0606
gold base/custom top



Lido armchair
TLI600-38BB
Kvadrat Divina3



Lido sofa
TLI601-3800
custom fabric

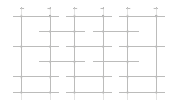

Modulare bookshelf
TLM630-0935
triple module/brass/h300cm



Beuta vase
TCC920-3132
platinum



Products



Galleria lamp
TGA210-0540
satin nickel



Acca coffee table
TTH613-2121
silver base/lepanto marble top



Tre Maniglie trolley
T3M610-0144
chrome/glass



Truno sofa
TRU600-38BB
Kvadrat Divina3



Products

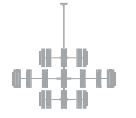

Varesina lamp
TVA120-0922
brass/manganese



Piedi Regolabili round table
TPR605-1335
gold base/brass feet/glossy top



Ampolla Alta vase
TCC942-3232
dark blue



Products



Pagoda Piantana lamp
TPG400-2920
terracotta/sandstone



Zoagli armchair
TZO630-3333
yellow



Zoagli sofa
TZO620-3333
yellow



Zoagli pouf
TZO640-3333
yellow



Pestello ashtray
TCC980-1511
Sivec marble/brass



Products



Pagoda Piantana lamp
TPG400-2920
terracotta/sandstone



Zoagli armchair
TZO630-2222
manganese/white cushions



Zoagli sofa
TZO620-2222
manganese/white cushions



Zoagli pouf
TZO640-2222
manganese/white cushions



Arezano Wireless lamp
TAR330-0965
brass



Pestello ashtray
TCC980-1511
Sivec marble/brass

Fabric proposals



DEDAR Amuleto



DEDAR Farniente

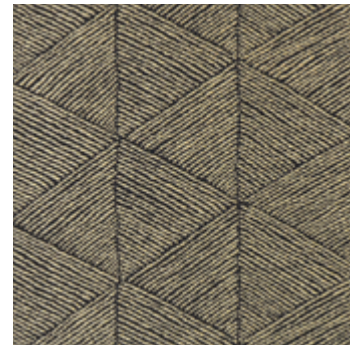

DEDAR Fr Alaya

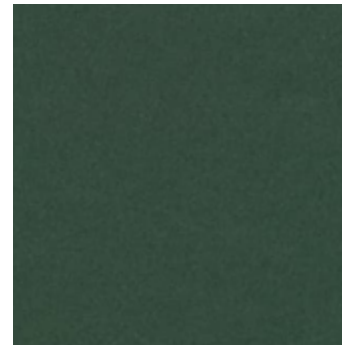

KVADRAT Divina 3



KVADRAT Hero Heather



KVADRAT Maple



DEDAR Lindon R



DEDAR Nimbus



DEDAR Tiger Beat

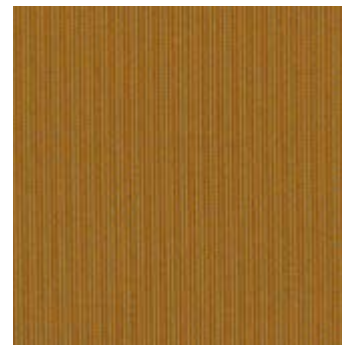

KVADRAT Patio

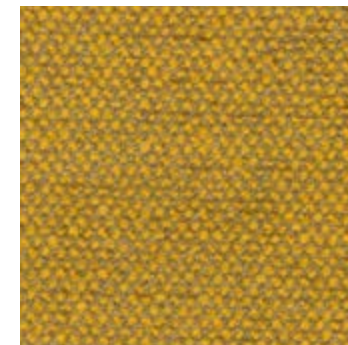

KVADRAT Safire



KVADRAT Steelcut Trio



RUBELLI Derby Toile



RUBELLI Fabthirty



RUBELLI Fabthirty+



KVADRAT Vidar 4



TATO Selection Lario Velvet



TATO Selection Florida Leather

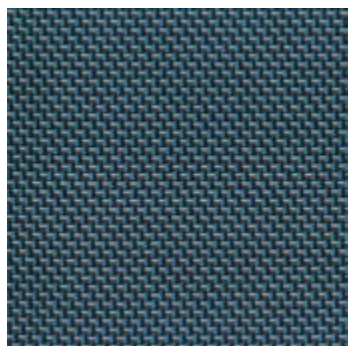

RUBELLI Nexus



RUBELLI Rattoppato



RUBELLI Scott

Marble



Carrara

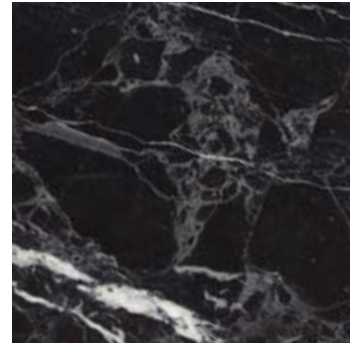

Marquinia

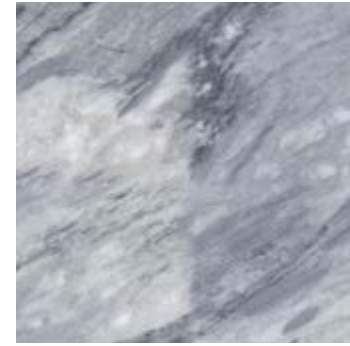

Grey

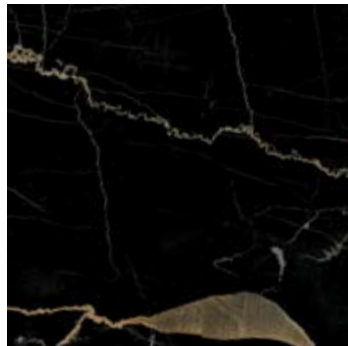

Portoro



Emperador

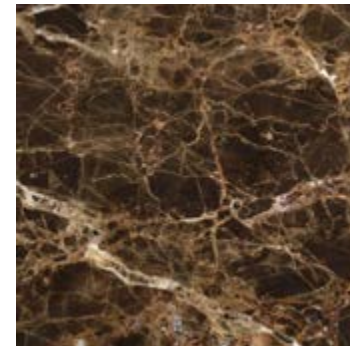

Emperador Dark

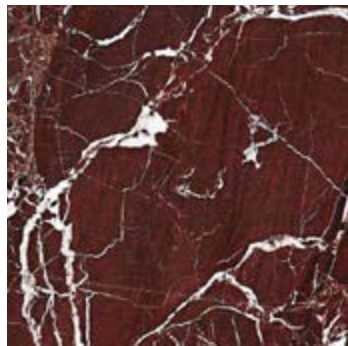

Lepanto



Alpi



Siena

Wood



Satin walnut



Glossy lacquer
(RAL Classic chart)



Satin lacquer
(RAL Classic chart)



Brown durmast



Black durmast

CREDITS

Concept & Styling

Alessandro Pasinelli Studio

Graphic design

TATO

Photos

Antonio Maniscalco, Tiziano Sartorio, Unidea,
Davide Arena, Pauliina Salonen, Annabel Elston

Image production

ZoneLab
TATO

Printed by

Tipografia Testori

Special Thanks

Studio Gardella, Gio Ponti Archives,
Lorenza Bozzoli Design, Studio Matteo Nunziati,
Azalea Seratoni Gualdoni

All products, specifications and data could be subject to change
without notice to improve reliability, function, design or otherwise.
Pictures and information present on the website and catalogues
don't have any contractual value.
All product dimensions are in cm.



All products are according to the EC directives

©2024 TATO, all rights reserved

No text, layout or pictures may be used or reproduced for commercial purposes by third parties, including dealers,
retailers, internet shops and other, without prior approval by TATO.



