

Modern



MODERN

PAESAGGI DOMESTICI

DOMESTIC LANDSCAPES

Questo volume vuole raccontare il nuovo approccio di Elledue al design. Uno stile moderno che predilige linee pulite senza però rinunciare a materiali pregiati e a dettagli raffinati. Ambienti che esprimono un lusso equilibrato, da vivere e da condividere. Scenografie della casa in cui ad essere protagonisti sono arredi, imbottiti ed elementi di fit-out eleganti, che rispondono alle attuali esigenze dell'abitare.

This volume aims to portray Elledue's new approach to design. A modern style that favors clean lines without compromising precious materials and refined details. Spaces that exude a balanced luxury to be experienced and shared. Home scenarios that frame elegant furniture, upholstery and fit-out elements as the main stars which cater to the demands of contemporary life.





L'ARTE DI COMBINARE ARTIGIANALITÀ E INNOVAZIONE

WHERE ART MEETS INNOVATION AND CRAFTSMANSHIP

La Qualità come stile di vita. Creare abbinamenti cromatici personalizzati, scegliere i materiali più pregiati e abbinarli meticolosamente, lavorarli con maestria per valorizzarli al meglio. È così che lavoriamo, coinvolgendo nel processo creativo e produttivo maestri artigiani locali, tanto ambiziosi quanto noi.

Quality as a lifestyle. Creating customised chromatic combinations, choosing the finest materials and meticulously matching them, working on them with competence to highlight their features. Our work involves local master artisans, who are as ambitious as us, in the creative and manufacturing process.

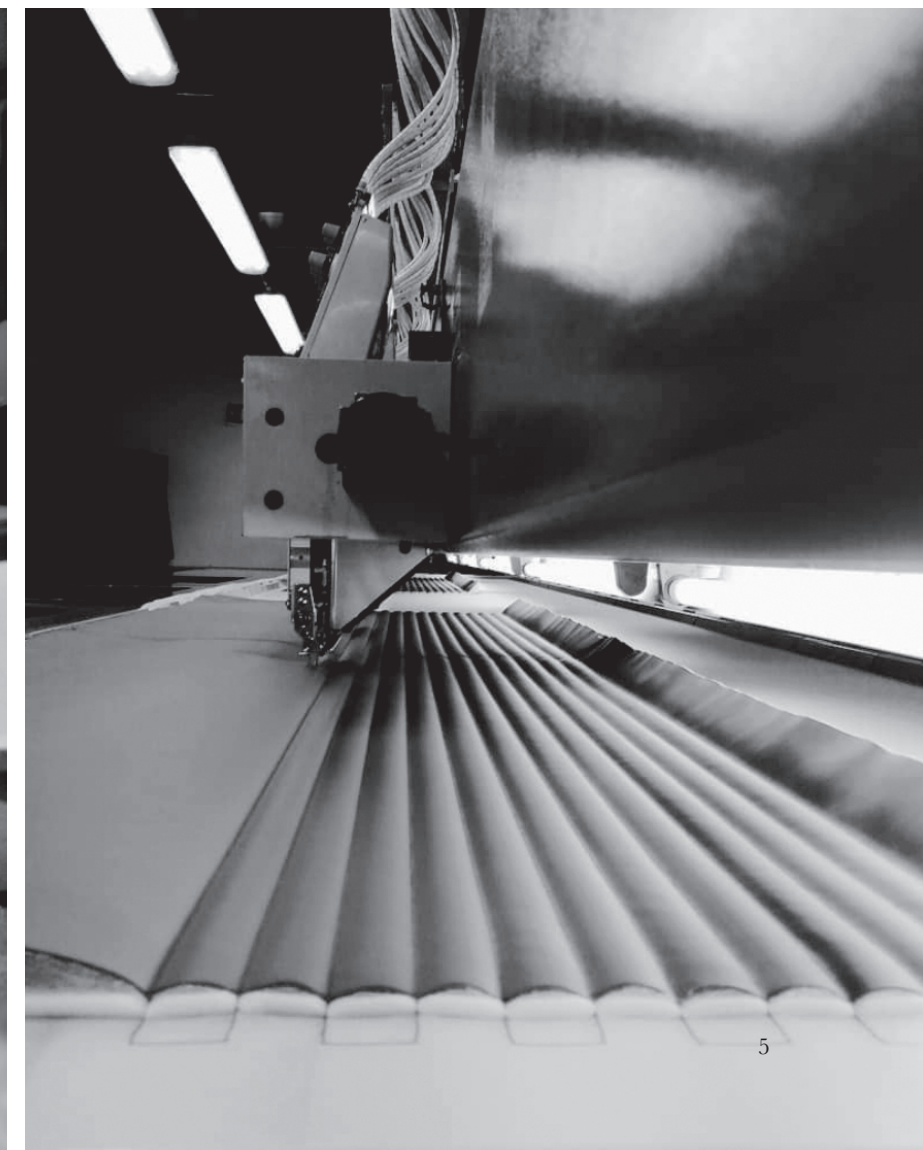
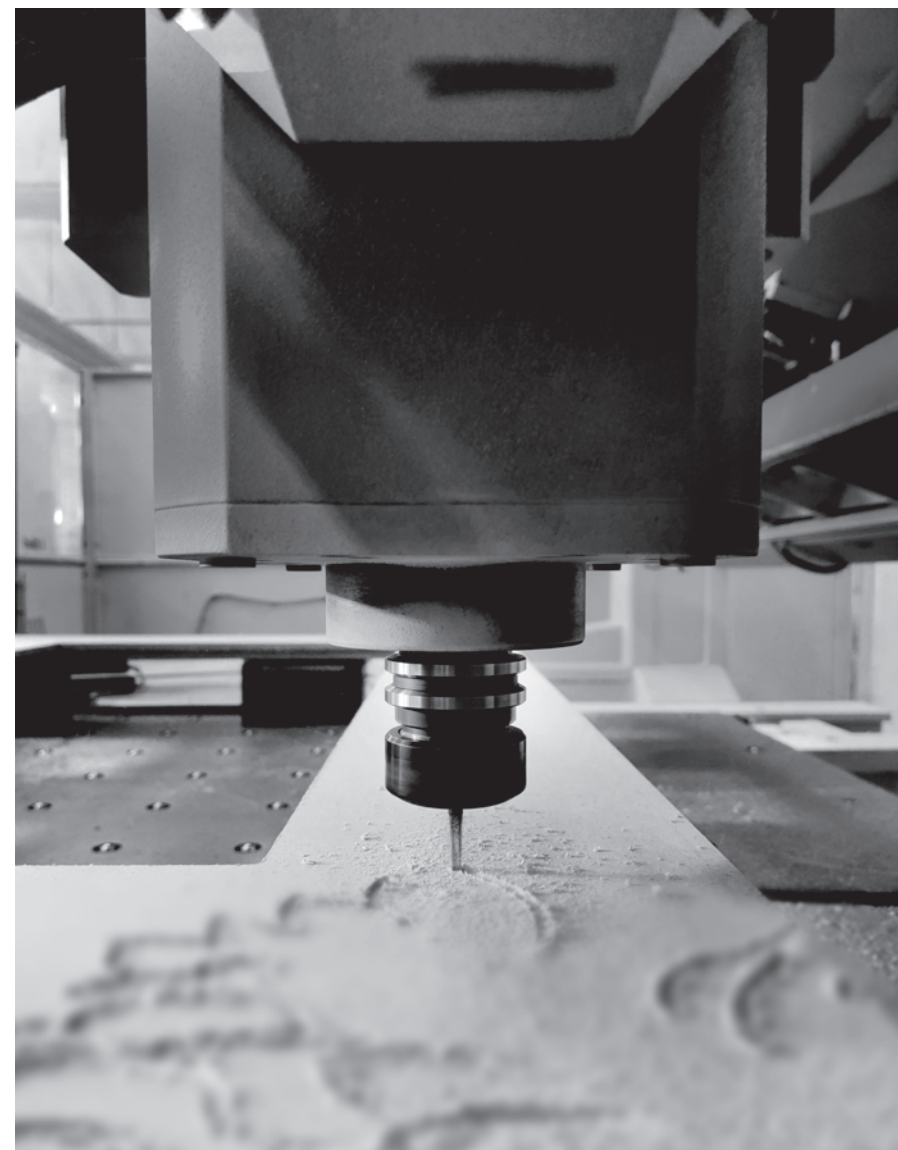



Modern

LIVING
08, 48, 70

DINING
80

BEDROOMS
112, 126, 144, 156

HOME OFFICE
160

KITCHEN
170

DOORS
184

BOISERIE
200



Living
CULTURA
DELLA CASA
A PASSION FOR INTERIORS

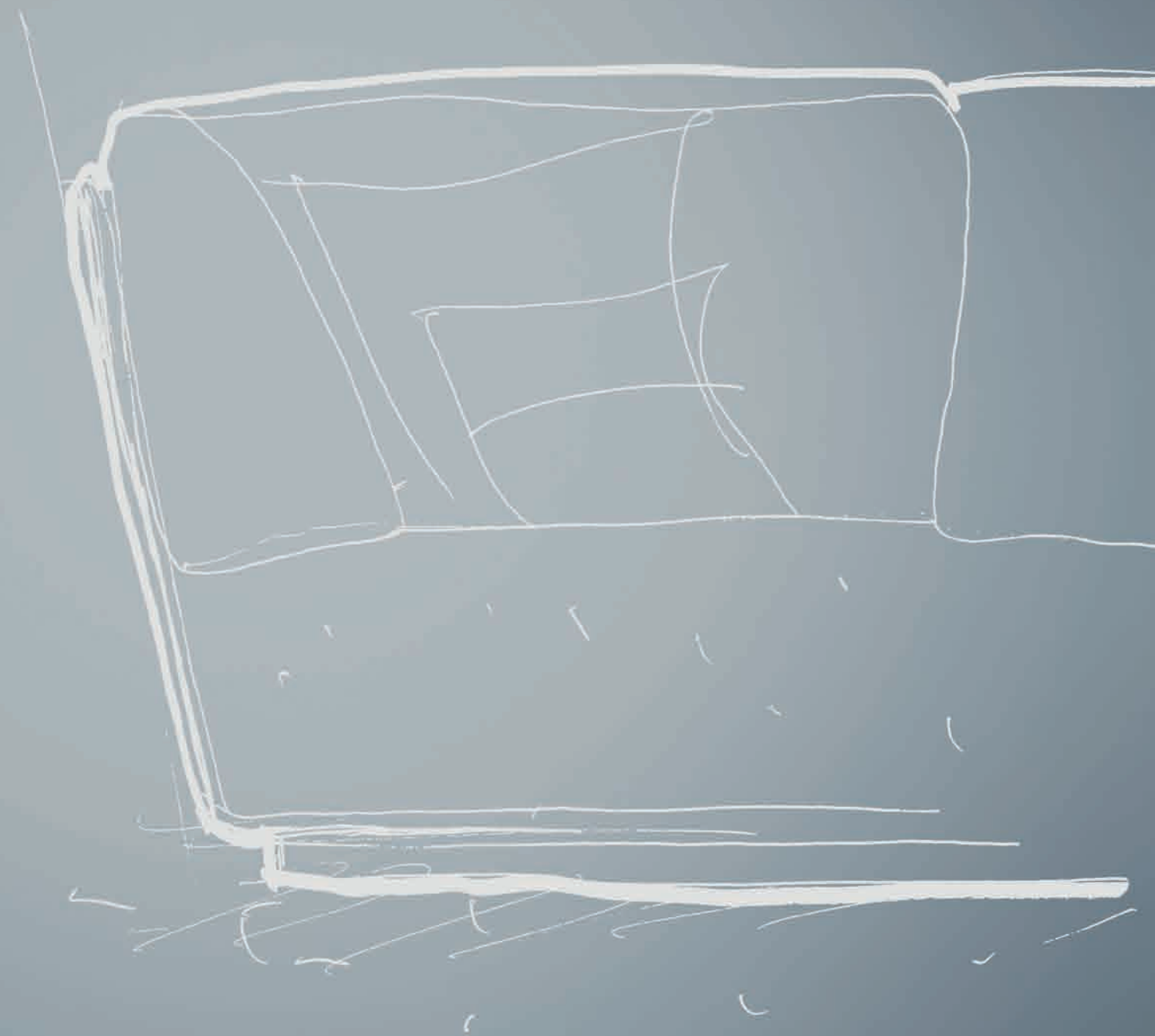

ARREDARE CON CLASSE E SEDUZIONE

FURNISHED WITH CLASS AND CHARM

Ambienti eleganti sono al centro della scena. Progettati con attenzione in modo che ogni singolo pezzo possa spiccare nella sua unicità. Arredi che seducono e trasformano la scena domestica in una vetrina di emozioni.

Elegant living spaces take the centre stage. Finely designed so that each individual piece can stand out in its uniqueness. Furniture that captivates and turns the domestic scene into a showcase of emotions.







VESTA Composition 2
Modular sofa
Cm. 260x93x78h.

VESTA Composition 3
Modular sofa
Cm. 308x93x78h.

VESTA Composition 4
Modular sofa
Cm. 298x298x78h.



VESTA E I SUOI BRACCIOLI CON INSERTO IN OTTONE
O INTERAMENTE RIVESTITI IN PELLE.
LUSSO PERSONALIZZABILE



VESTA AND ITS ARMRESTS WITH BRASS INSERT
OR FULLY UPHOLSTERED IN LEATHER.
CUSTOMISABLE LUXURY



VESTA S 1504
Armchair
Cm. 110x93x78h.



VESTA S 1501 SX
Terminal element
Cm. 103x93x78h.

VESTA S 1501 DX
Terminal element
Cm. 103x93x78h.



VESTA AT 1502
Coffee table
Cm. Ø120x40h.

VESTA AT 1501
Coffee table
Cm. Ø55x60h.





VESTA AT 1503
Coffee table
Cm. Ø115x36h.





VESTA AC 1502
Back sofa console
Cm. 185x45x55h.





VESTA AC 1501
Console
Cm. 185x45x77h.

VESTA M 1501
Mirror
Cm. Ø100h.

VESTA M 1503
Mirror
Cm. 104x204h.



PENELOPE LA 1016
Little armchair
Cm.69,5x77,5x69h.





ZEUS S 3013
3 seater sofa
Cm. 229x105x80h.





ETRA AT 1413
Coffee table
Cm. Ø74x41h.





ETRA AT 1413
Coffee table
Cm. Ø74x41h.



ETRA AT 1414
Coffee Table with Sliding Mechanism
Cm. Ø74x41/59h.



LA BELLEZZA È UNA SCELTA PERSONALE

BEAUTY IS A PERSONAL CHOICE



Zebano Ulivo Olive tree Noce Canaletto Canaletto Walnut Radica Pipa Pipe Burl



Palissandro Rosewood Paduk Laccato nero Black lacquered Plexiglass



Quarzo Quartz Quarzo rosa Pink Quartz Quarzo Fumè Smoke Quartz Alabastro Alabaster



Diaspro orbicolare Orbicular Jasper Labradorite Lapis blu Lapis blue Diaspro rosso Red Jasper



Oro Gold Cromo Chrome Satinato Satin Nickel nero Black Nickel

Scegliete la combinazione di materiali che più si avvicina al vostro stile.

Select the material combination that closely matches your style.





ETRA AT 1401
Coffee table
Cm.48,7x48,7x41,5h.



ETRA LA 1402
Armchair
Cm. 85x84x74h.





VESTA F 1501
Flower box
Cm. Ø36x106h.

VESTA F 1502
Flower box
Cm. Ø42x66h.



PROPOSTE

PROPOSALS

In queste pagine presentiamo alcune soluzioni d'arredo per la zona living realizzabili con le collezioni di imbottiti Elledue. Grazie alla flessibilità della nostra azienda, non vincolata alle rigide logiche della produzione in serie, seguiamo ogni progetto individualmente e siamo in grado di offrire ai nostri clienti infinite possibilità di scelta. Per questo, le nostre creazioni si possono definire alto artigianato contemporaneo.

In these pages we present some furnishing solutions for the living area that can be made with Elledue upholstered furniture collections. Thanks to the flexibility of our company, which is not bound to the rigid logic of mass production, we follow each project individually and we are able to offer our clients endless possibilities. For this reason, our creations can be defined as high contemporary craftsmanship.



01
COMPOSITION



02
COMPOSITION



03
COMPOSITION



Living
DEFINIRE UN LUOGO
E UN'ATMOSFERA
RENDENDOLI UNICI

A SPACE AND ATMOSPHERE DEFINED
BY THEIR UNIQUENESS

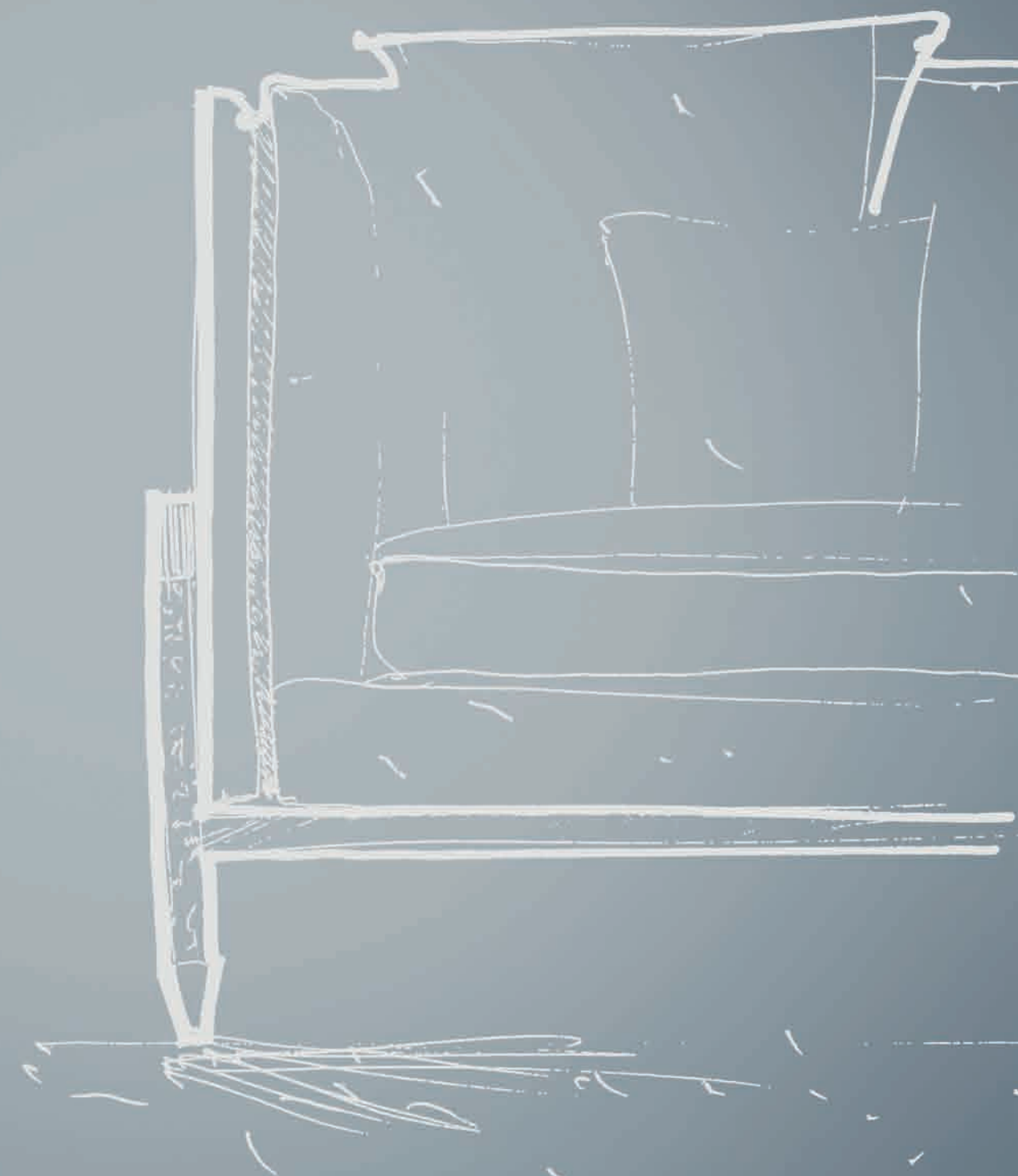



IL GIUSTO EQUILIBRIO

STRIKING THE PERFECT BALANCE

Creatività e cultura del design: i cardini di un approccio che persegue l'armonia. Artigianalità e gusto raffinato creano il giusto equilibrio tra materiali diversi che ben si fondono nel dare forma a luoghi pensati per la convivialità.

Creativity and design culture: the cornerstones of an attitude that pursues harmony. Craftsmanship and refined taste create the perfect balance between different materials, which blend harmoniously in shaping places designed for conviviality.

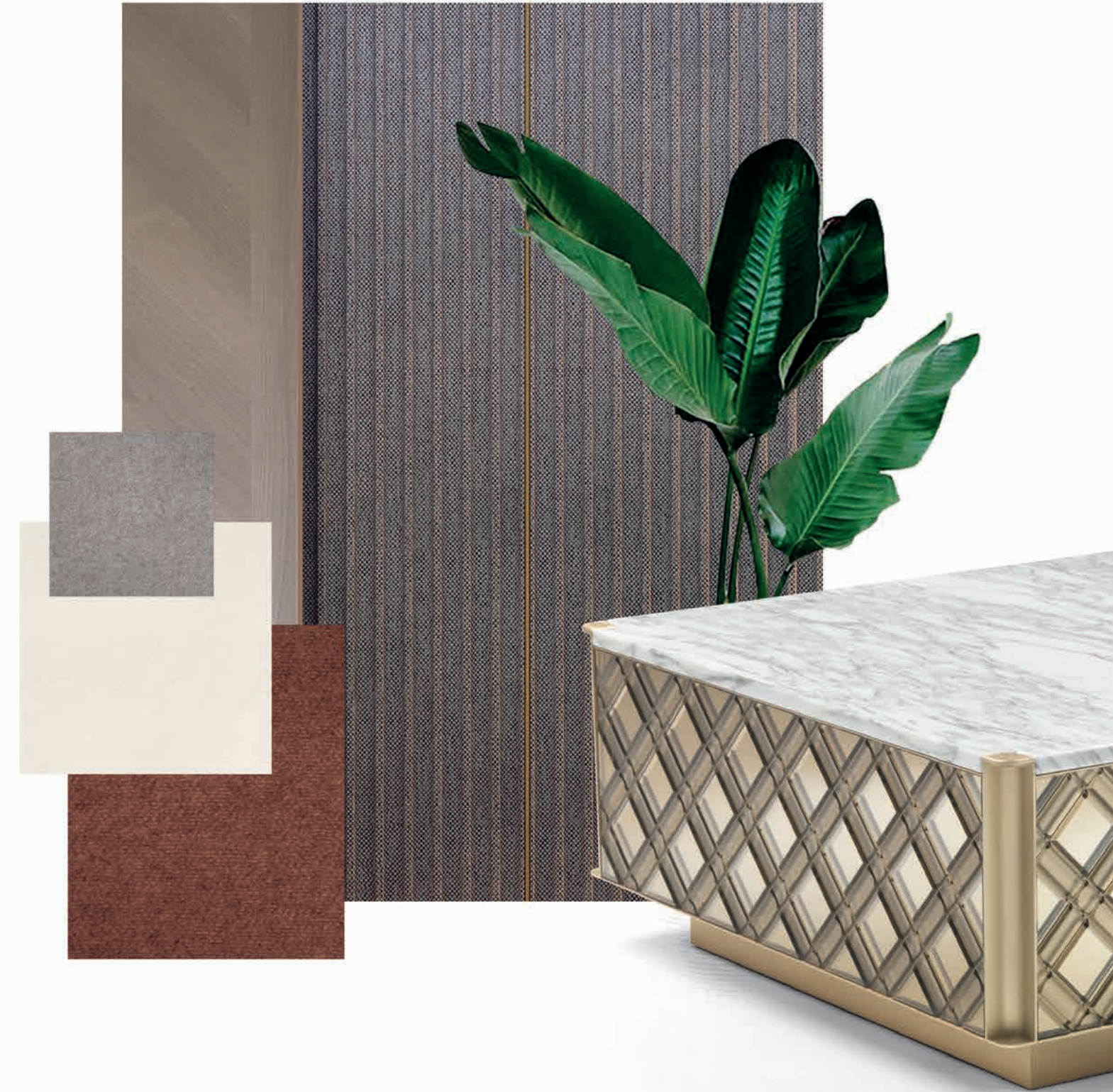





ETRA LA 1401
Armchair
Cm.73x73x68h.







ETRA S 1403
3 seaters sofa
Cm. 241x92x75h.



UNO STILE RAFFINATO,
FRUTTO DI UNA COSTANTE
RICERCA ESTETICA

A REFINED STYLE, THE RESULT OF
CONSTANT AESTHETIC RESEARCH



TESEO AT 1301
Coffee table
Cm. 87x87x36h.



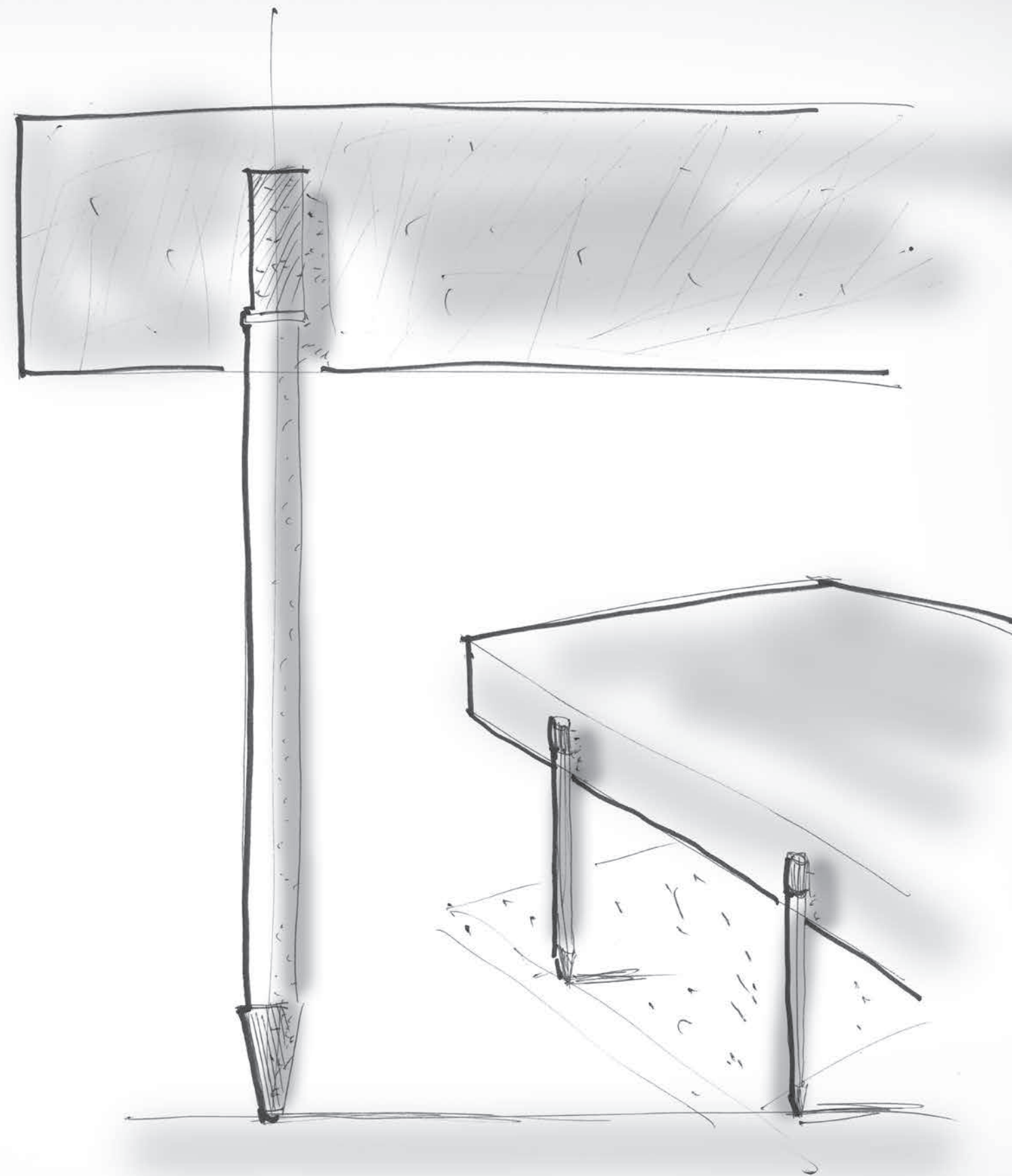

ETRA AT 1411
Long coffee table
Cm. 153x49x45h.



ETRA C 1401-MA
High sideboard with central marble
Cm.120x51x163h.

ETRA C 1404-MA
4 doors sideboard with marble top
Cm.240x51x87h.





ETRA LA 1404
Armchair
Cm.73x68x74h.





PROPOSTE

PROPOSALS



04
COMPOSITION



05
COMPOSITION



Living
L'ELEGANZA COME
SEGNO DISTINTIVO

ELEGANCE AS A DISTINGUISHING TRAIT

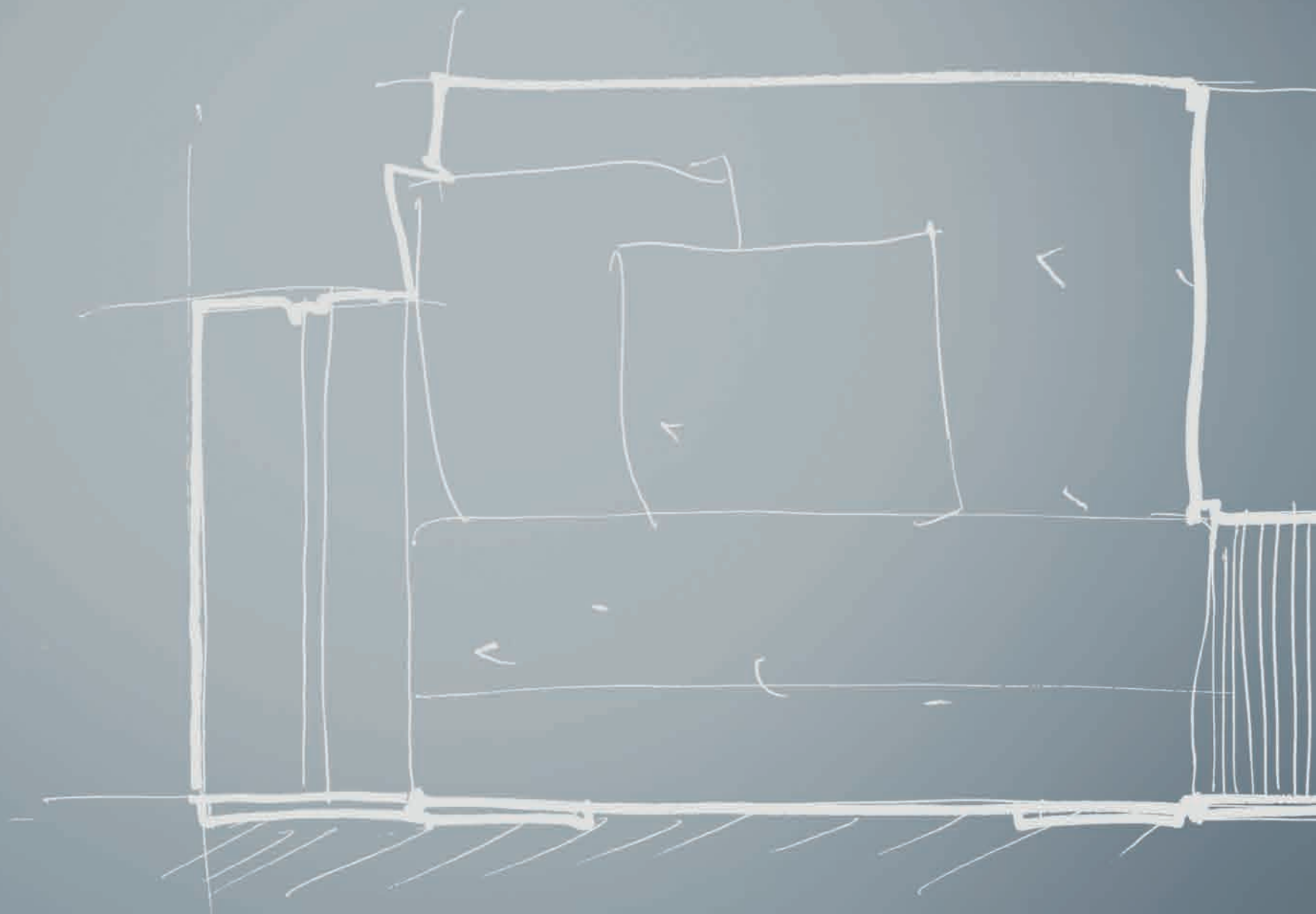

UN LINGUAGGIO PROGETTUALE RAZIONALE E CONTEMPORANEO

A RATIONAL AND CONTEMPORARY DESIGN APPROACH

Il living proposto da Elledue, con il nuovo divano Etra, è un ambiente piacevole che trasmette benessere. Niente è lasciato al caso, e ogni dettaglio è meticolosamente concepito per esprimere l'idea di un lusso discreto ed affascinante.

The living room presented by Elledue, showcasing the new Etra sofa, is a beautiful space that exudes wellness. Nothing is left to chance, and every detail is carefully conceived to express the art of subtle and intriguing luxury.







ETRA LINE Composition 01
Modular sofa
Cm.177x102x96h.

ETRA LINE Composition 02
Modular sofa
Cm.300x102x96h.

ETRA LINE Composition 03
Modular sofa
Cm.423x102x96h.

ETRA LINE Composition 05
Modular sofa
Cm.423x173x96h.



PROPOSTE

PROPOSALS



06
COMPOSITION



07
COMPOSITION



Dining
SCENARI DI CLASSE
CHE EMANANO
ELEGANZA

HIGH-CLASS SCENARIOS THAT EXUDE ELEGANCE



DEDICATO AI CULTORI DEL BELLO

DEDICATED TO BEAUTY LOVERS

Una collezione esclusiva che lascia trapelare l'incredibile passione alla base della sua creazione. Tra i dettagli spiccano finiture sofisticate, piani in marmo pregiato, rivestimenti in pelle ed esclusivi inserti in metallo. Sono i piccoli dettagli a costituire il valore aggiunto di questa collezione e a renderla unica.

An exclusive collection that reveals the incredible passion behind its creation. The details include sophisticated finishes, fine marble tops, leather upholstery and exclusive metal inserts. It is the small details that make up the added value of this collection and make it unique.







UN TAVOLO A MISURA
DI DESIDERIO

A TABLE FIT FOR WISHES



VESTA T 1501
Table
Cm. 380x130x76h.



VESTA T 1502
Table
Cm. 270x110x76h.



VESTA T 1503
Table
Cm. Ø160x76h.

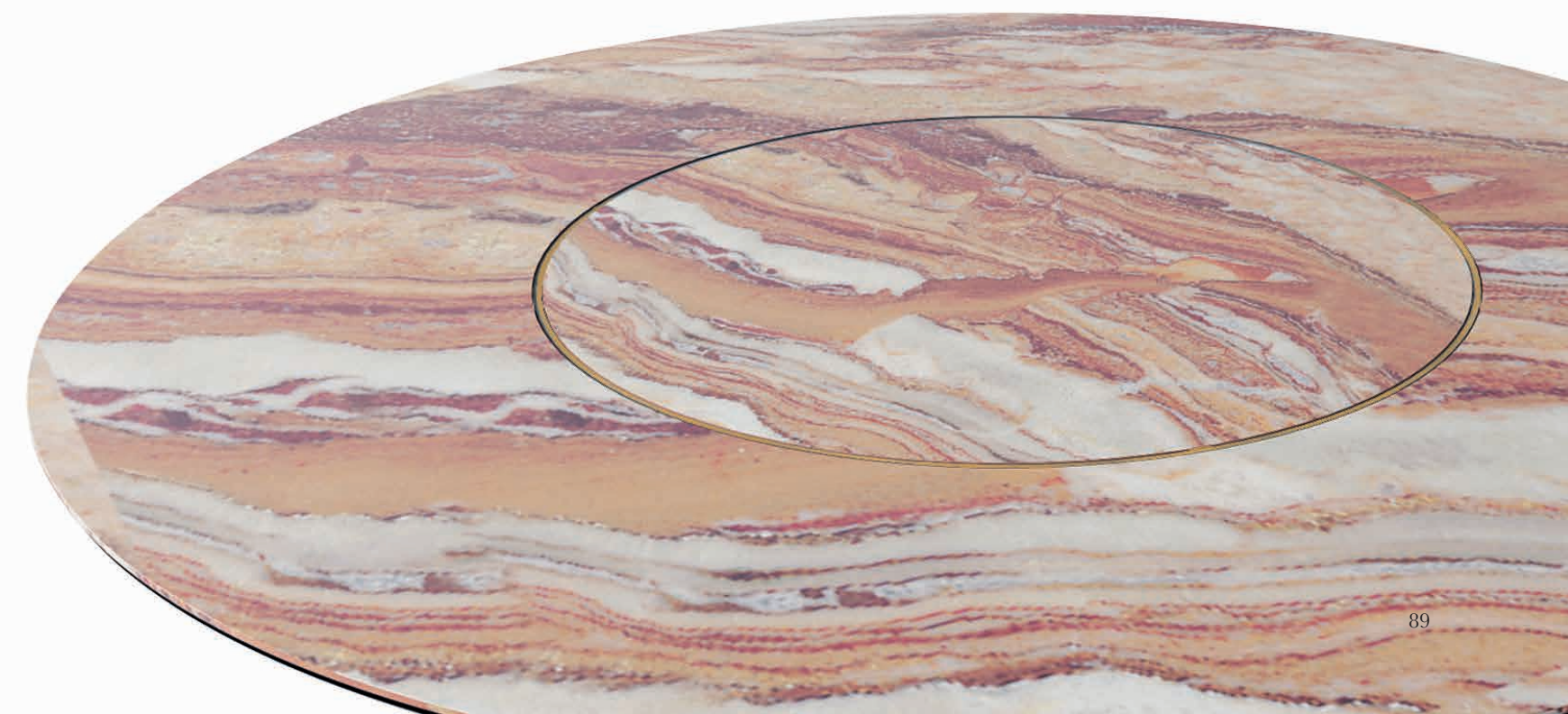



VESTA T 1503
Table
Cm. Ø180x76h.



VESTA LA 1503
Chair
Cm.63x63x86h.



VESTA LA 1504
Chair
Cm. 62x55x86h.



VESTA LA 1502
Chair
Cm. 69,5x77,5x69h.





VESTA LA 1501
Chair
Cm. 63x57x80h.





VESTA C 1502-B
Bar high sideboard
Cm. 134x61x178h.





VESTA C 1501
Sideboard
Cm. 223x52x78h.





LA BELLEZZA DELLA FORMA,
IL VALORE DELLA
FUNZIONALITÀ

THE BEAUTY OF FORM,
THE VALUE OF FUNCTIONALITY



VESTA AH 1502
TV holder
Cm.223x51x58h.

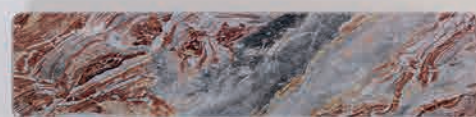

08
COMPOSITION



09
COMPOSITION



10
COMPOSITION



11
COMPOSITION



Bedroom
UNA NUOVA
INTERPRETAZIONE
DELLO SPAZIO NOTTE

A NEW INTERPRETATION OF THE NIGHT SPACE

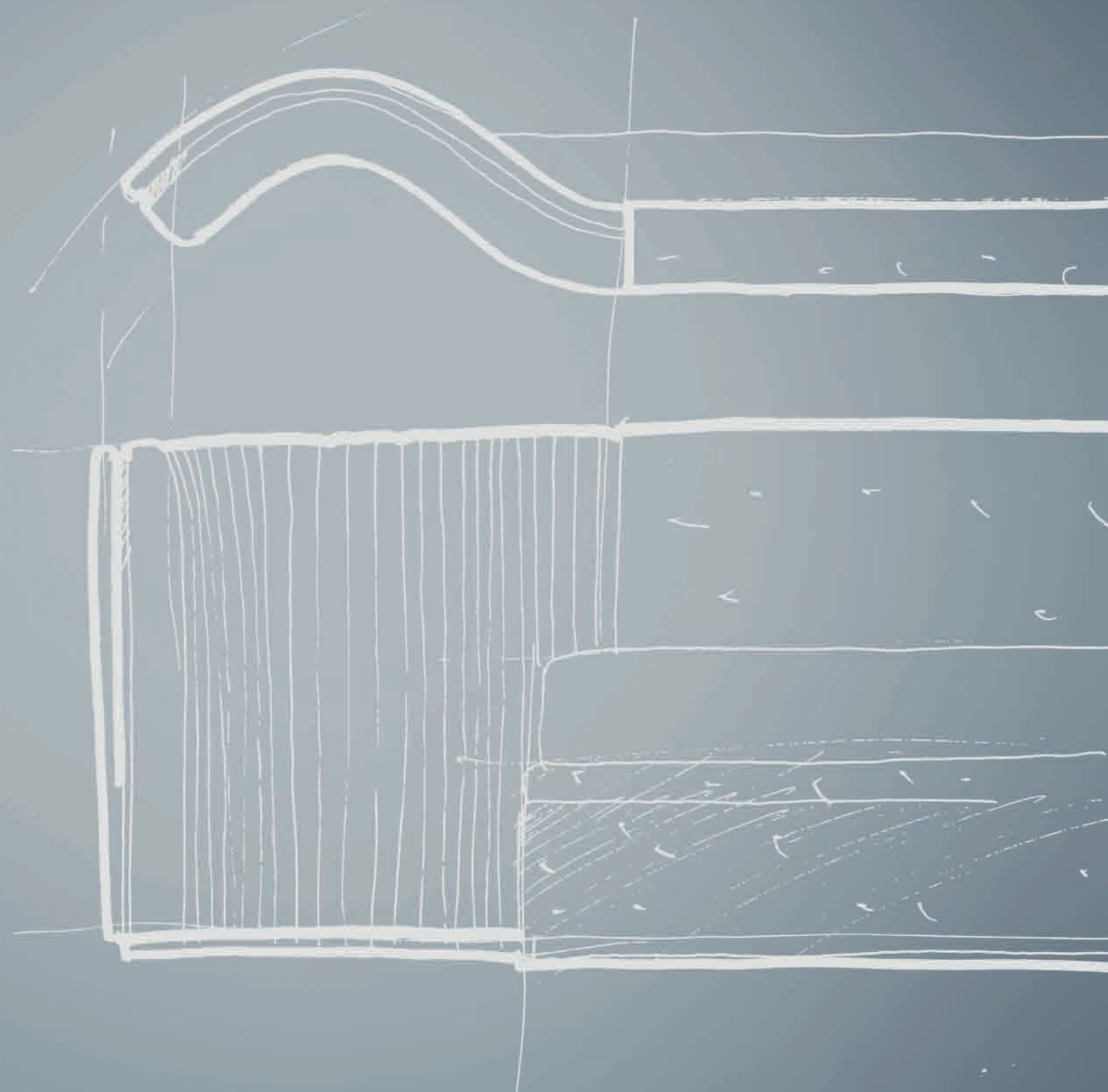

DALLA TRADIZIONE ALL'INNOVAZIONE

FROM TRADITION TO INNOVATION

Elledue propone un nuovo modo di vivere lo spazio notte, con progetti alternativi in cui la creatività e l'innovazione hanno come alleato la tradizione. Spazi che infondono relax e benessere, in cui il comfort è un valore imprescindibile.

Elledue proposes a new way of experiencing the sleeping space, with alternative designs in which creativity and innovation have tradition as their ally. Spaces that infuse relaxation and well-being, where comfort is an essential value.

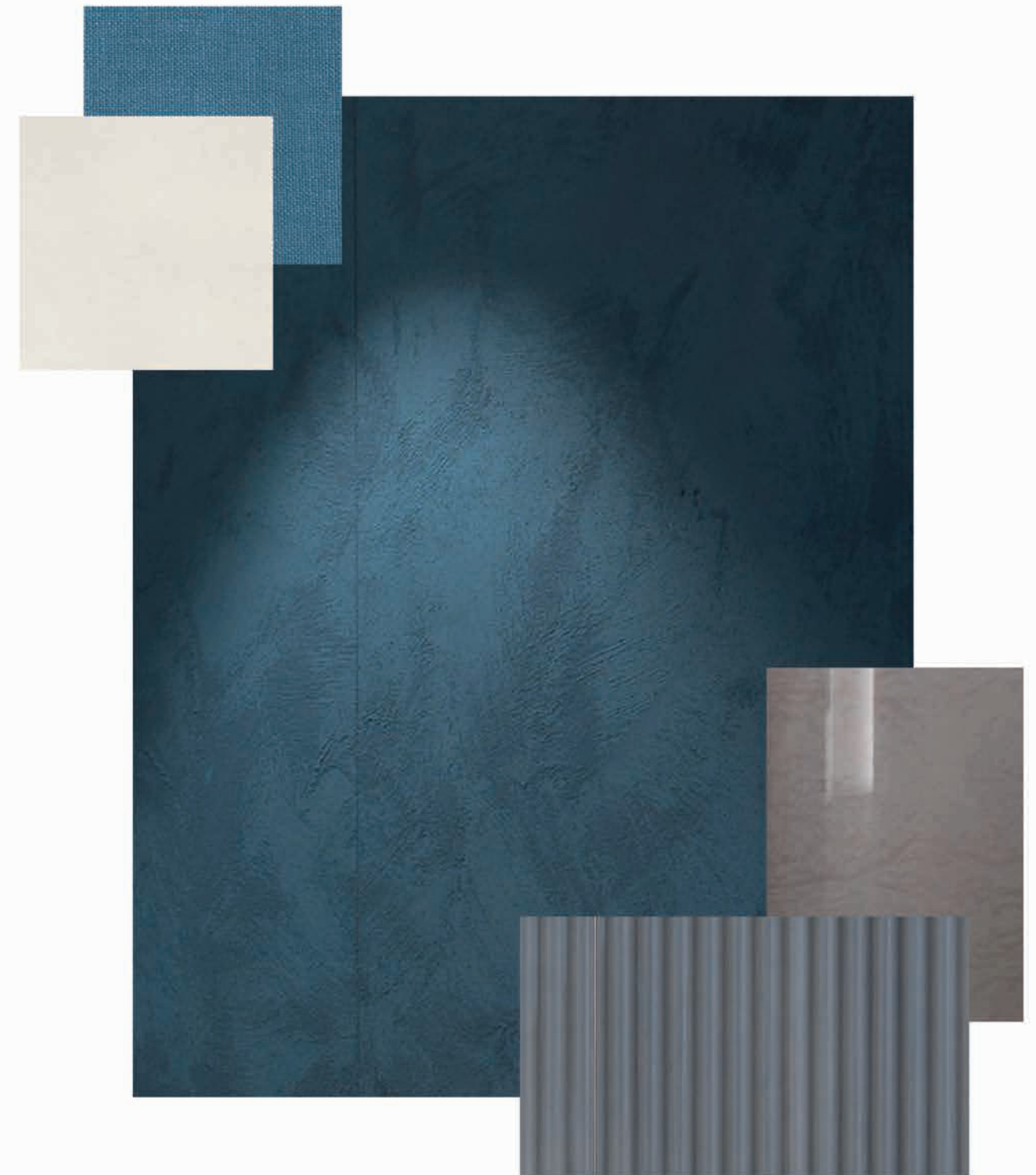





ETRA B 1410
Bed
Cm.400x216x118h.

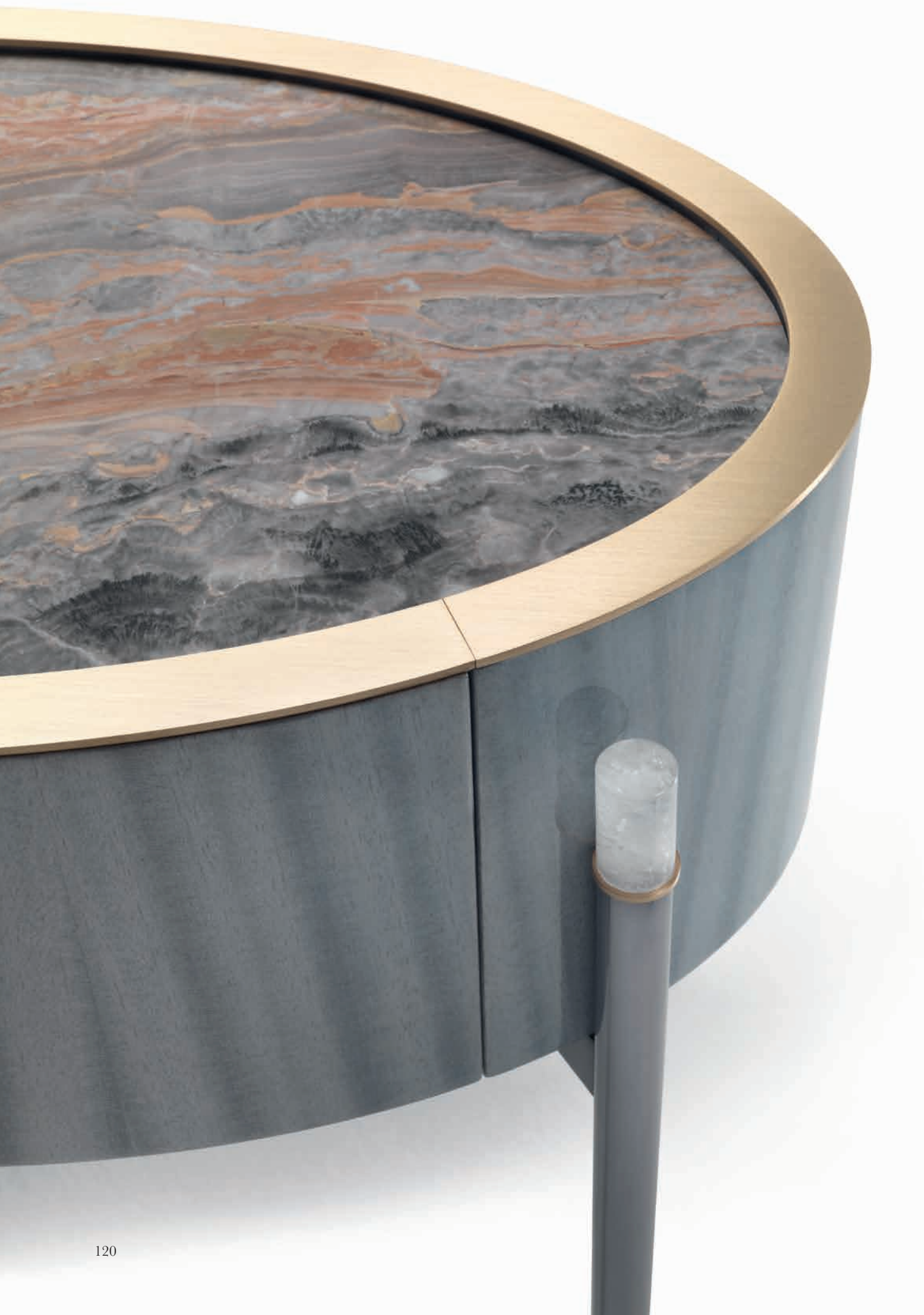

ETRA B 1414
Bedside table
Cm. 61x37x45h.



ETRA LA 1402
Armchair
Cm. 85x84x74h.



ETRA LA 1403
Chair
Cm. 62x62x82h.



PASSIONE PER I DETTAGLI

PASSION FOR DETAILS



ETRA AS 1401
Desk
Cm. 125,6x55x8x74h.

ETRA LA 1403
Chair
Cm. 62x62x82h.





Bedroom
LA MAGIA
DEI DETTAGLI
THE MAGIC OF DETAILS



VOLUMI IMPORTANTI E SENSO DELLE PROPORZIONI

SIGNIFICANT VOLUMES AND SENSE OF PROPORTION

L'incessante lavoro di ricerca del bello sfocia nella creazione di accostamenti inediti e di piacevoli contrasti. Come in questa proposta per la zona notte, ambientata in un'elegante casa e caratterizzata dall'accostamento di forme pure e contemporanee. Styling moderno e perfetti accostamenti cromatici creano una nuova armonia, capace di affascinare e sorprendere nel tempo.

The relentless pursuit of beauty results in the creation of unusual combinations and delightful contrasts, such as the ones characterising this night space proposal. Set in an elegant home, this bedroom features a combination of pure, contemporary shapes. Modern styling and perfect colour matches create a new harmony that will fascinate and surprise over time.







VESTA B 1502
Bed
Cm. 234x244x124h.

VESTA B 1503
Bedside table
Cm. 60x40x43h.







VESTA B 1504
Chest of drawers
Cm. 180x56x80h.







IL NUOVO LINGUAGGIO STILISTICO PER LA ZONA NOTTE

THE NEW DESIGN LANGUAGE
FOR THE SLEEPING AREA



VESTA B 1501
Bed
Cm. 250x225x112h.



Bedroom
FORME ELEGANTI
E MORBIDI VOLUMI

ELEGANT SHAPES AND SOFT VOLUMES

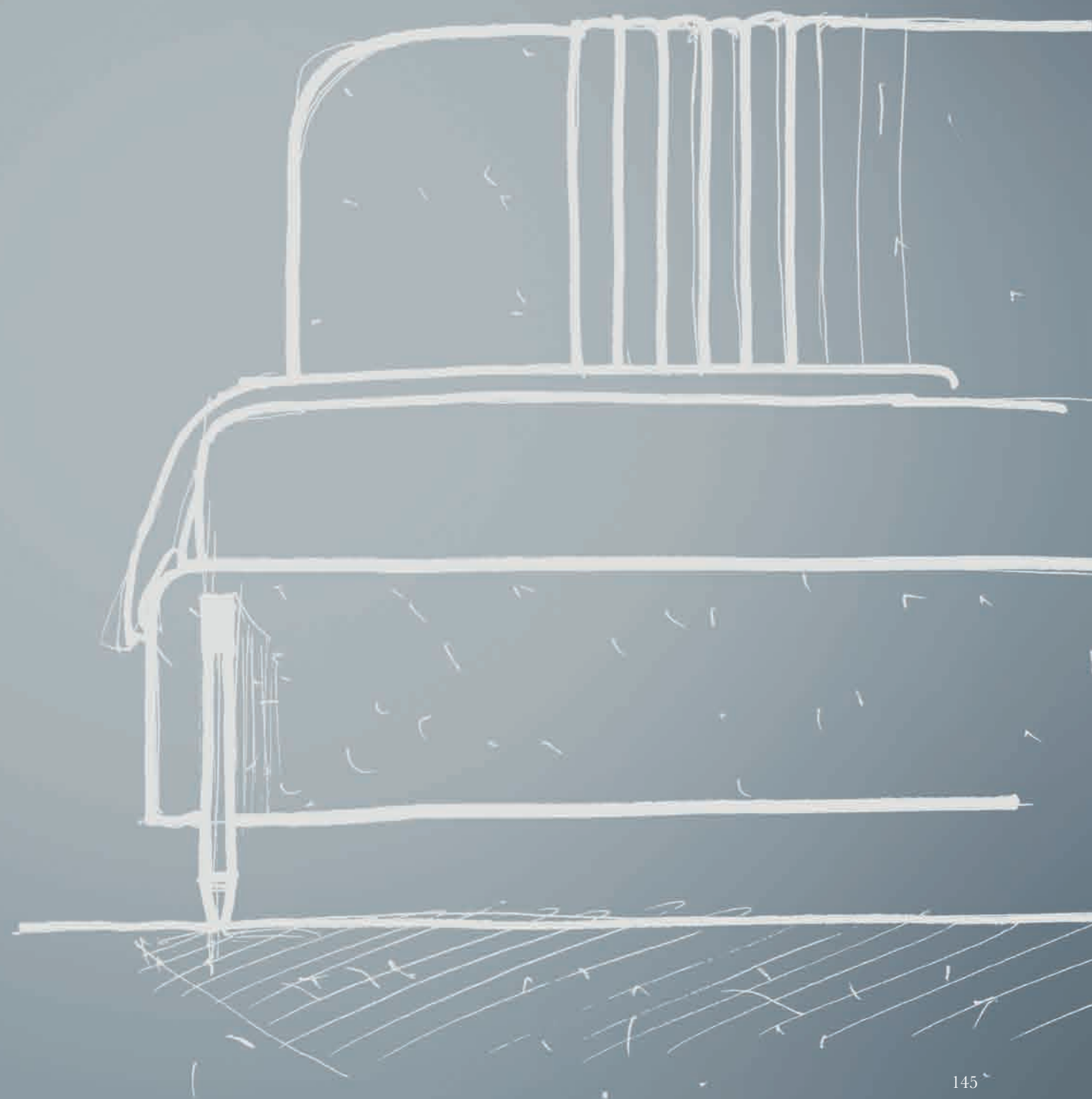

UN DESIGN MODERNO ED ESSENZIALE

A MODERN AND ESSENTIAL DESIGN

Un'area notte dalle proporzioni contemporanee, le cui forme lineari sono impreziosite ed esaltate da nuances ricercate. Uno spazio esclusivo studiato all'insegna della leggerezza che si distingue per il design moderno ed essenziale.

A sleeping area with contemporary proportions, whose linear forms are embellished and enhanced by sophisticated nuances. An exclusive space conceived in the name of lightness that stands out for its modern and essential design.







ETRA B 1401
Bed
Cm.221,5x210x180h.

ETRA B 1402 SX/DX
Bedside table
Cm.61x51x43h.



PENELOPE LA 1021
Armchair
Cm.64x58x69h.



L'ELEGANZA NON
È UN'OPINIONE

ELEGANCE IS NOT AN OPINION



ETRA S 1401
Armchair
Cm. 122x92x75h.





FORME RIGOROSE PER
UNO STILE ESCLUSIVO
RIGOROUS SHAPES FOR AN EXCLUSIVE STYLE



ETRA P 1402
Bench
Cm. 207x80x52h.



Bedroom
IL QUOTIDIANO
VIVERE TRA
ELEGANZA E DESIGN
EVERYDAY LIVING BETWEEN ELEGANCE AND DESIGN



ETRA B 1406

Bed
Cm. 248x224x132h.

ETRA B 1402 SX/DX

Bedside table
Cm. 61x51x43h.

ETRA B 1403

Chest of drawers
Cm. 116,6x52,8x74h.



Home office
LINEE CONTEMPORANEE
PER UN NUOVO
CONCETTO DI
HOME OFFICE

CONTEMPORARY LINES FOR A
NEW HOME OFFICE CONCEPT

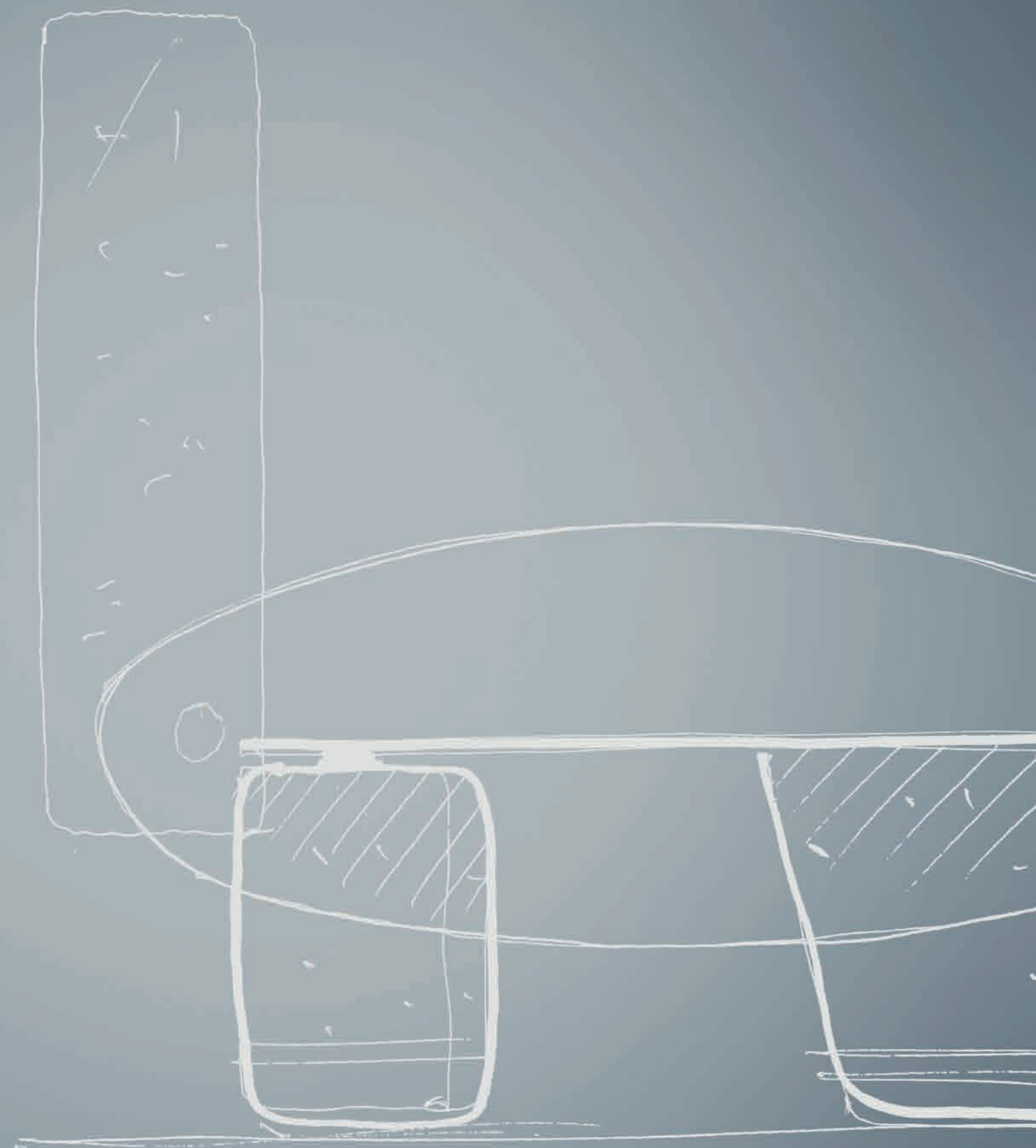



RAFFINATE CROMIE CREANO UN NUOVO MOOD

REFINED HUES CREATE AN EXQUISITE MOOD

La sintesi di un progetto per l'Home Office particolarmente riuscito, che spicca per l'unicità del design e per la sua disinvolta eleganza. Una sensazione di calda accoglienza che rende il luogo del pensiero confortevole e raccolto.

The synthesis of a particularly successful home office project, which stands out for its unique design and casual elegance. A warm, welcoming feeling that makes the workspace comfortable and cosy.







VESTA USC 1501
Desk
Cm. 270x202x87h.

VESTA USC 1502
Desk
Cm. 270x120x87h.

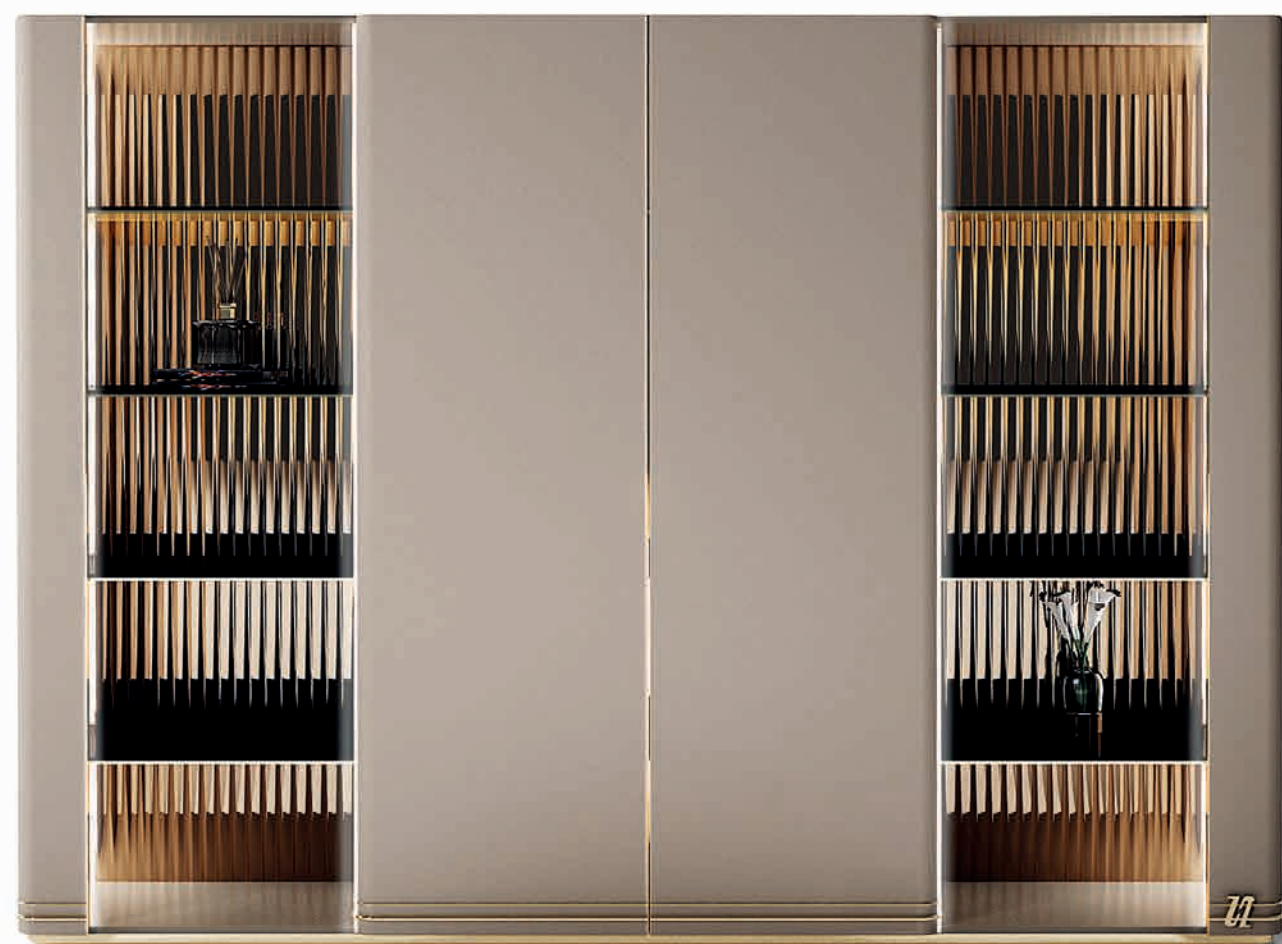

VESTA UMB 1501
Tv holder
Cm. 265x55x178h.



VESTA UMB 1502
Bookshelf
Cm. 180x55x178h.



Kitchen
L'UNICITÀ DELLE CUCINE
ELLEDUE, TRA FUNZIONALITÀ
ED EMOZIONE

ELLEDUE UNIQUE KITCHENS:
BETWEEN FUNCTIONALITY AND EMOTION

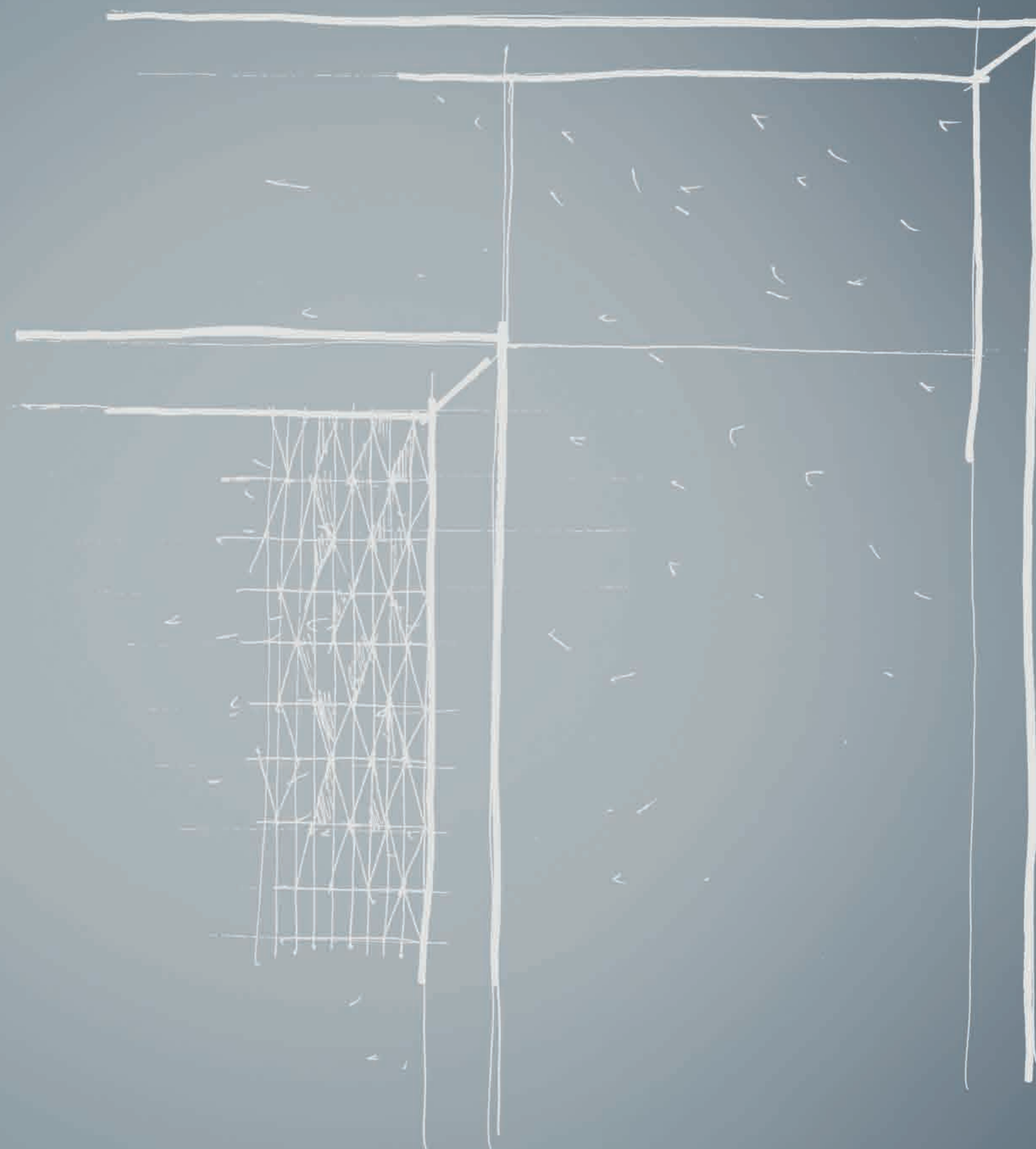

LA CUCINA È IL CUORE DELLA CASA

THE KITCHEN: THE HEART OF THE HOME

C'è molto carattere nelle proposte per la cucina di Elledue, dove un'attenta progettazione cura le proporzioni, i volumi e i dettagli, mantenendo altissimi i livelli di funzionalità ed estetica. Soluzioni d'arredo in perfetto equilibrio tra eleganza e un nuovo modo di riscoprire il bello e l'esclusività.

There is a lot of character in Elledue's kitchen proposals, where careful design takes care of proportions, volumes and details, while maintaining high levels of functionality and aesthetics. Furnishing solutions in perfect harmony between elegance and a new way of rediscovering beauty and exclusivity.













ETRA LA 1407
Stool
Cm. Ø46x68h.





Doors
PORTE PER INTERNI
PERSONALIZZATE
BESPOKE INTERIOR DOORS

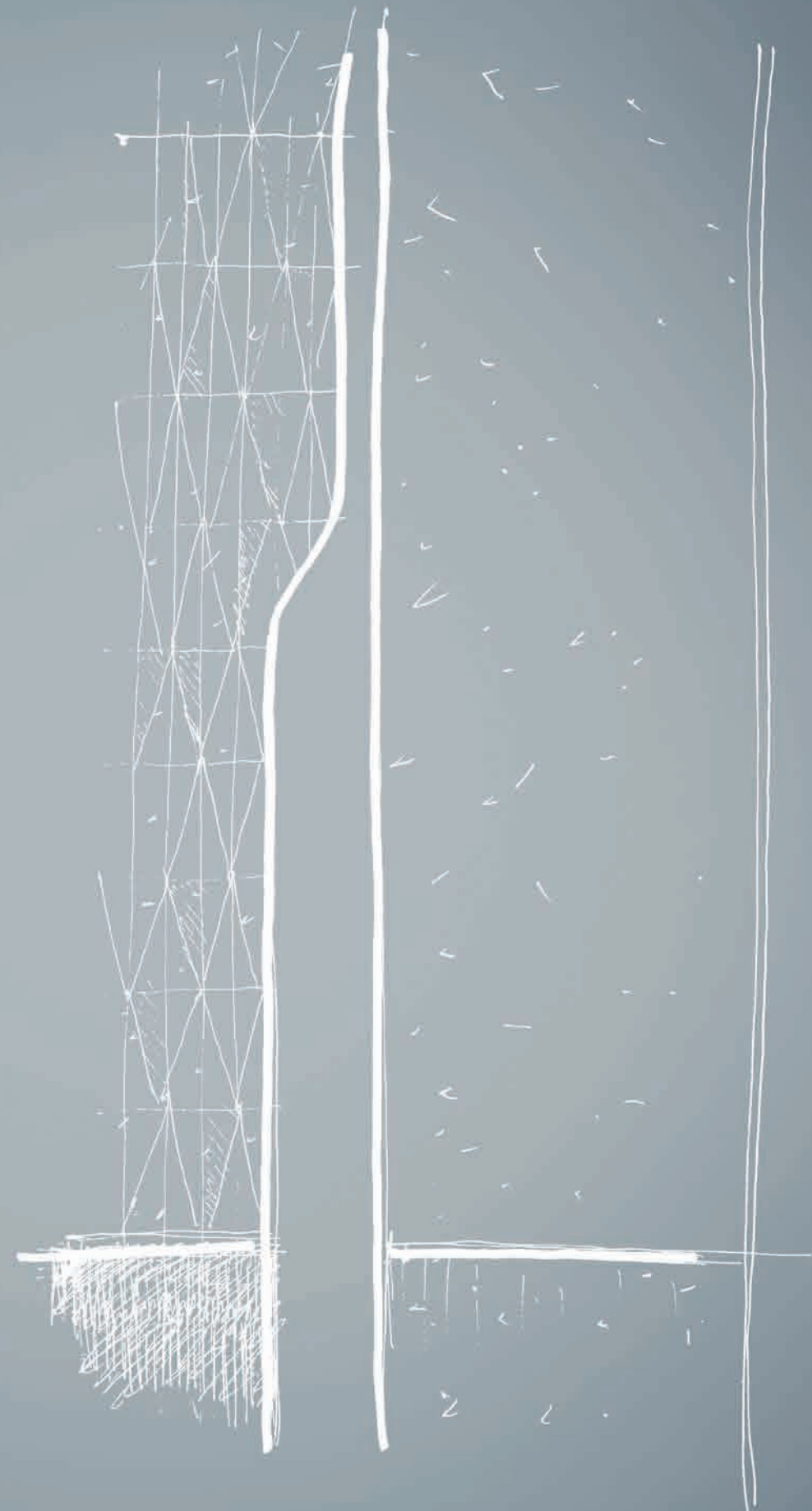

PORTE PER INTERNI PERSONALIZZATE

BESPOKE INTERIOR DOORS

Oltre alla loro funzione pratica, le porte sono veri e propri elementi d'arredo con un forte valore estetico. Crediamo che una porta su misura possa davvero fare la differenza in un progetto di interior design di lusso. Le nostre porte fanno parte di un approccio fluido e flessibile al design: dividono senza separare e perfezionano gli spazi con un mood unico. Ogni porta Elledue può essere personalizzata in termini di dimensioni, tipo di serratura, maniglie, mix di materiali e finiture.

Besides their practical function, doors are true furnishing elements with a strong aesthetic value. We believe that a custom-made door can truly make a difference in a luxury interior design project. Our doors are part of a fluid and flexible approach to design: they divide without separating and perfect spaces with a unique mood. Each Elledue door can be customised in terms of size, type of lock, handles, material mix and finish.





PENELOPE D 1502
Door
Cm.300x310h.



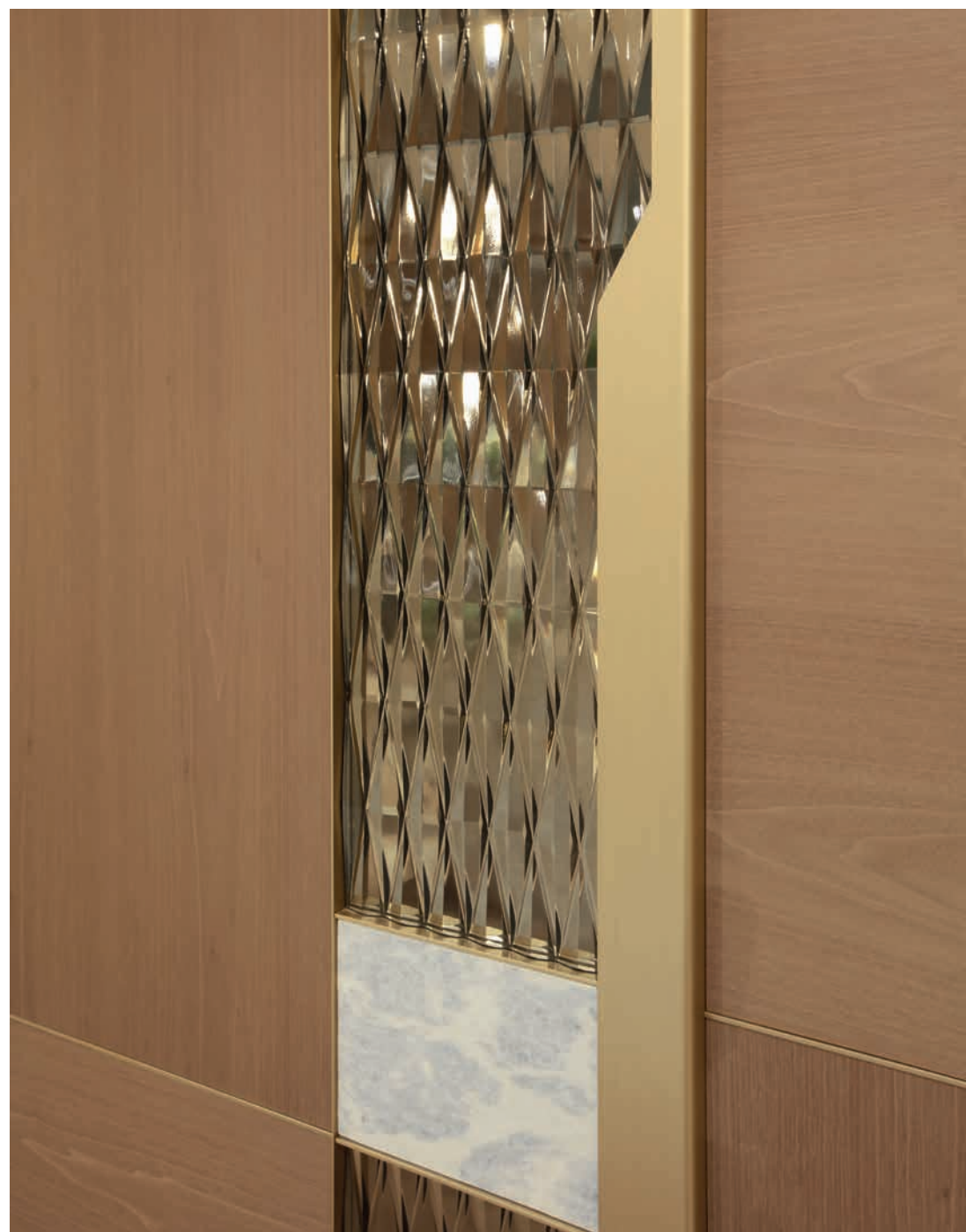

PENELOPE D 1502
Door
Cm.300x310h.





DECÒ
Door
Cm. 162x274h.



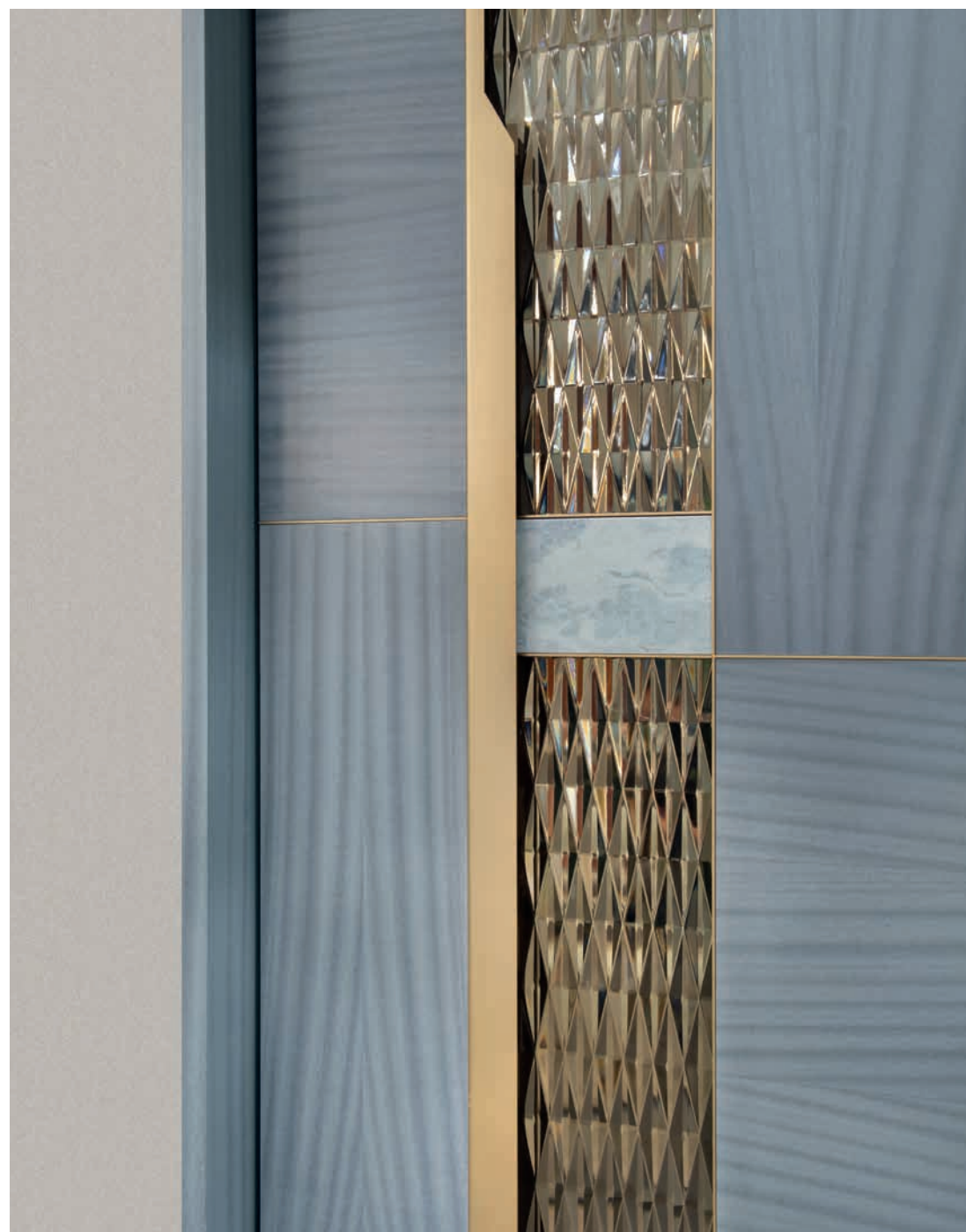

PENELOPE D 1501
Door
Cm. 150x310h.





TWENTY
Door
Cm.201x285h.





ALBION
Door
Cm. 243x297h.



Boiserie
LA BOISERIE,
LA NUOVA SCENOGRAFIA
DELLA CASA

BOISERIE: THE NEW HOME DECOR

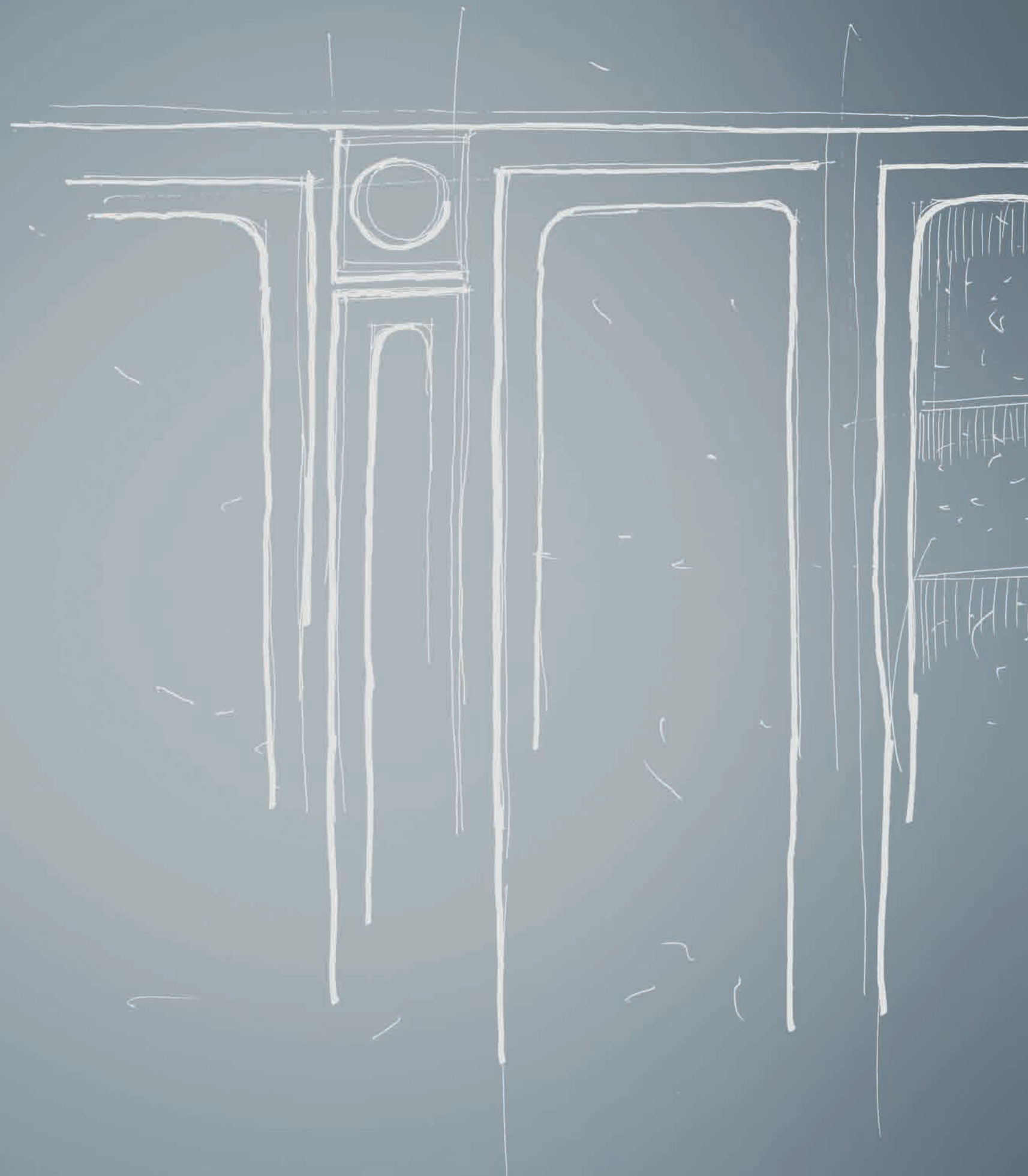





ALBION
Boiserie





ALBION
Boiserie



VESTA
Boiserie





GREEK

BOISERIE





LAVINIA

BOISERIE

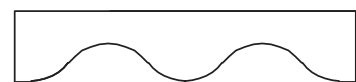



IONICA

BOISERIE

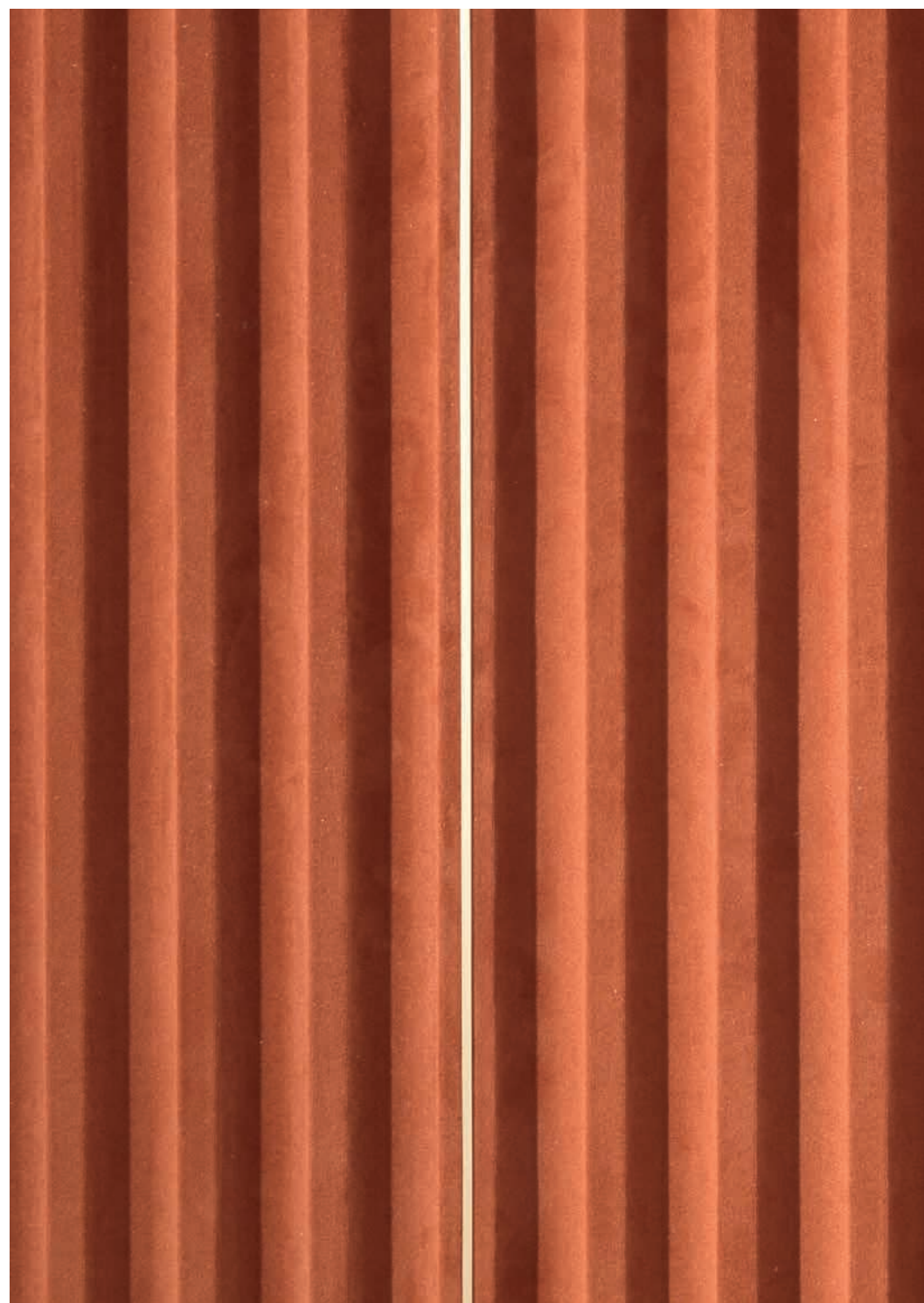



Finishes
ABBINAMENTI
CROMATICI E
FINITURE

COLOR COMBINATIONS AND FINISHES



ESSENZE WOOD VENEERS



Shiny white Erable
RE:242/S



Matt white Erable
RE:242/M



Shiny Eucalyptus ivory
RE:244/S

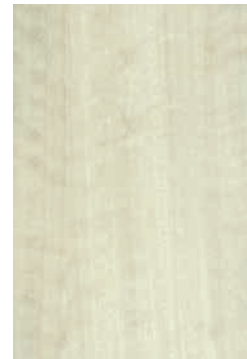

Matt Eucalyptus ivory
RE:244/M



Matt ice Ash
RE:225/M open pore



Matt ice Ash
RE:225/M



Shiny Pama
RE:207/S



Matt Pama
RE:207/M

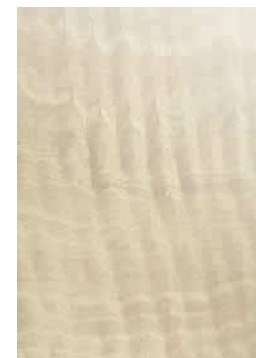

Shiny light Frisè
RE:205/S



Matt light Frisè
RE:205/M



Cherry Milano
RE:187

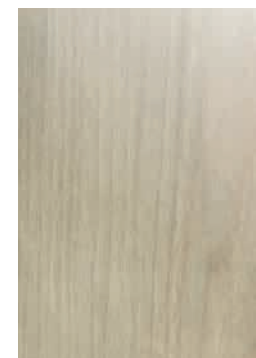

Shiny grey Canaletto
RE:222/S



Matt grey Canaletto
RE:222/M

ESSENZE WOOD VENEERS



Shiny grey Eucalyptus
RE:245/S



Matt grey Eucalyptus
RE:245/M



Stripe grey Wood shiny
RE:232/S



Stripe grey Wood matt
RE:232/M



Shiny turtledove Erable
RE:212/S



Matt turtledove Erable
RE:212/M



Shiny white Briar
RE:251/S A100



Matt white Briar
RE:251/M A20



Matt grey Birch
RE:238/M



Matt light Oak
RE:248/M open pore



Touch light Walnut
RE:201/T

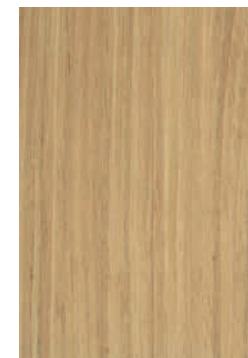

Matt light Walnut
RE:201/M



Matt natural Erable
RE:184/M



Matt natural Myrtle Briar
RE:108/M



Matt olive Ash
RE:185/M

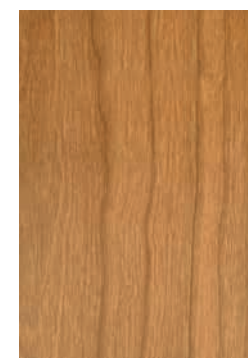

Matt Cherry
RE:101/M

ESSENZE WOOD VENEERS



Shiny Bubinga Briar
RE:155/S



Birch shiny Briar
RE:112/S

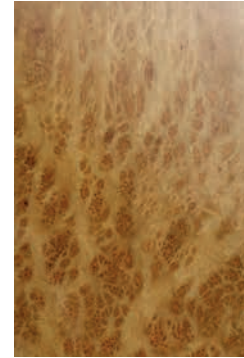

Shiny Myrtle Briar
RE:109/S

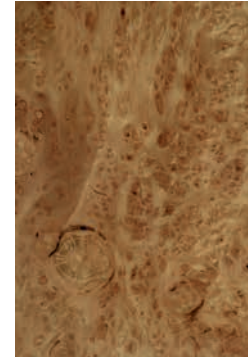

Matt Myrtle Briar
RE:109/M



Shiny Ash Briar dark
honey RE:224/S



Matt Ash Briar dark
honey RE:224/M



Shiny Elm Briar
RE:107/S

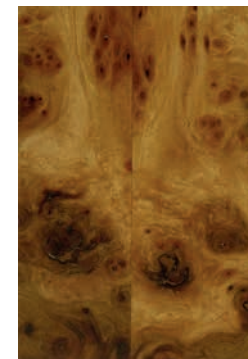

Matt Elm Briar
RE:107/M



Shiny pink Erable
RE:241/S

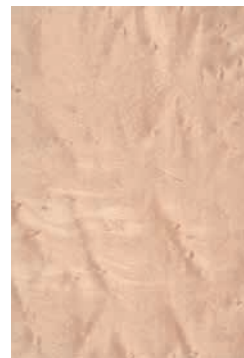

Matt pink Erable
RE:241/M



Feathered Mahogany
RE:246/SM



Feathered Walnut
RE:229/SM



Shiny tobacco Rosewood
RE:173/S



Matt tobacco Rosewood
RE:173/M

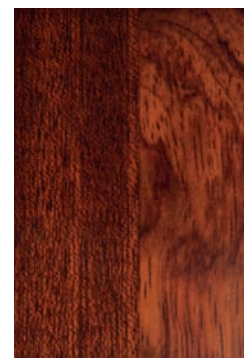

Matt Mahogany-
Bubinga Briar RE:103/M



Matt natural Bubinga
Briar RE:156/M

ESSENZE WOOD VENEERS



Matt Walnut
RE:114/M



Matt old Walnut
RE:172/M

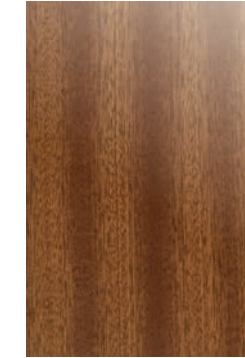

Shiny Mahogany
RE:102/S



Matt Mahogany
RE:102/M

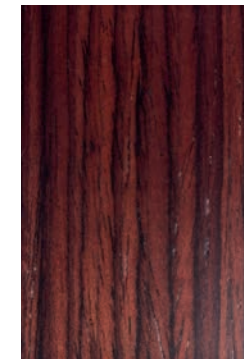

Matt East Rosewood
RE:166/M



Matt Sycamore Frisé
RE:105/M



Shiny Cinnamon
RE:253/S A100



Matt Cinnamon
RE:253/M A20

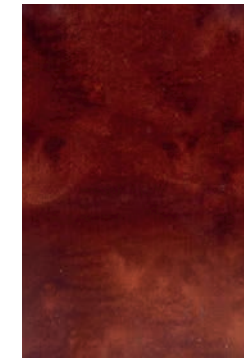

Matt Madrona Briar
RE:113/M



Matt California matt
Briar RE:133/M

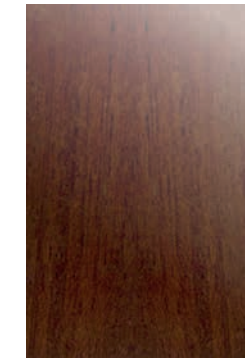

Shiny India Rosewood
RE:154/S



Matt India Rosewood
RE:154/M

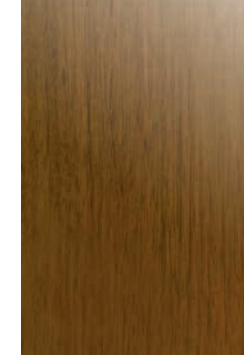

Shiny dark Walnut
RE:158/S



Matt dark Walnut
RE:158/M



Matt Ash fango
RE:178/M

ESSENZE WOOD VENEERS

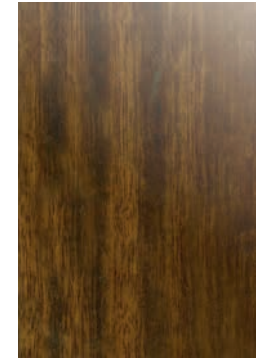

Shiny Thermo Eucalyptus
RE:240/S



Matt Thermo Eucalyptus
RE:240/M



Matt Eucalyptus Frisé
RE:197/M

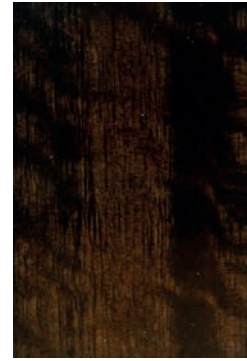

Matt Eucalyptus Fumè
RE:198/M



Shiny Eucalypto Terra
RE:252/S A100



Matt Eucalypto Terra
RE:252/M A20

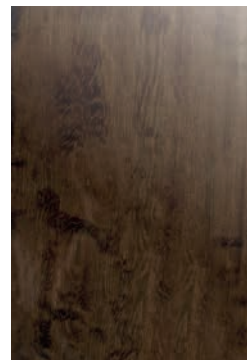

Shiny moka Eucalypto
RE:230/S



Matt moka Eucalypto
RE:230/M

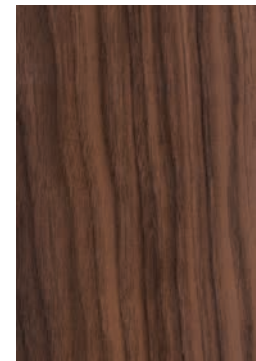

Matt Canaletto Walnut
RE:188/M



Matt Erable fango
RE:183/M



Shiny dark grey Ash
RE:204/S



Matt dark grey Briar
RE:204/M



Shiny Zebrano
RE:181/S

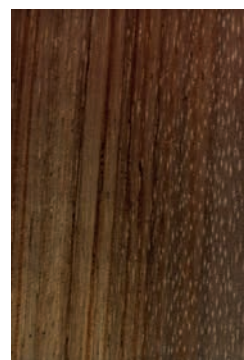

Matt Zebrano
RE:181/M

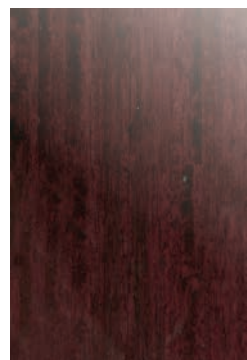

Shiny Bacco Eucalyptus
RE:193/S

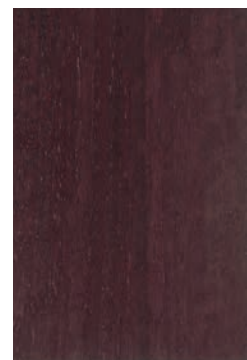

Matt Bacco Eucalyptus
RE:193/M

ESSENZE WOOD VENEERS

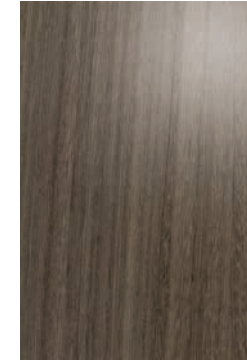

Shiny Smoke Wood
RE:221/S



Matt Smoke Wood
RE:221/M



Shiny Ebony "Alpi"
RE:180/S

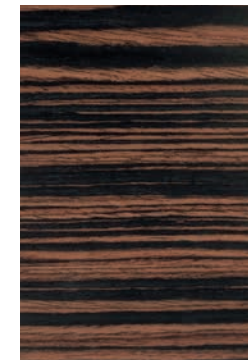

Matt Ebony "Alpi"
RE:180/M

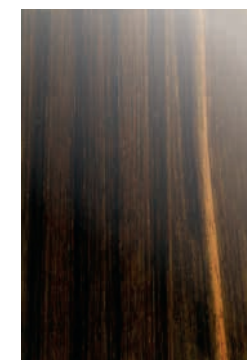

Shiny Ebony
RE:610/S

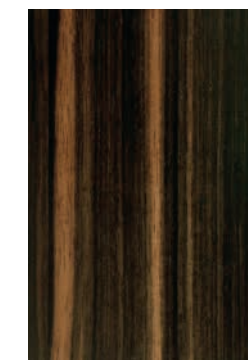

Matt Ebony
RE:610/M



Shiny black Ebony
RE:165/S



Matt black Ebony
RE:165/M

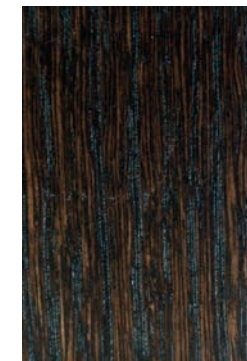

Matt paint Wengè
RE:164/M

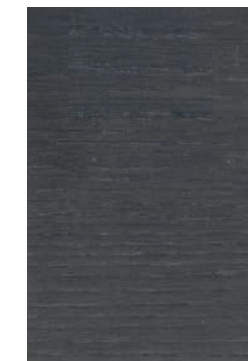

Matt iron Ash
RE:226/M

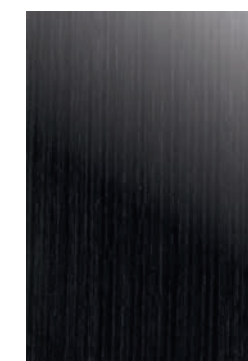

Shiny black Wood
RE:223/S

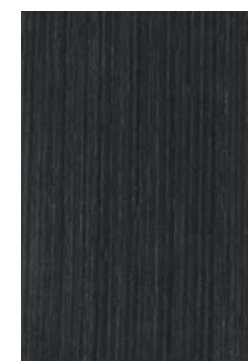

Matt black Wood
RE:223/M

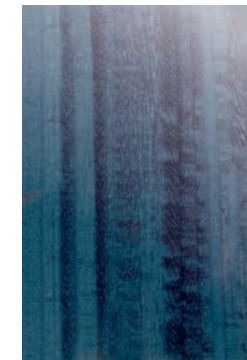

Shiny blue Eucalyptus
RE:194/S

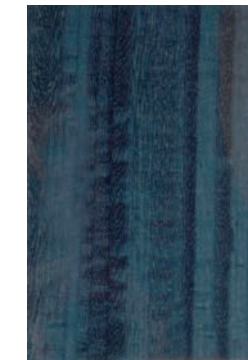

Matt blue Eucalyptus
RE:194/M



Shiny light-blu Wood
RE:255/S A100



Matt light-blu Wood
RE:255/M A20

LACCATURE LACQUERING



Hammered shiny white
RE:767/S

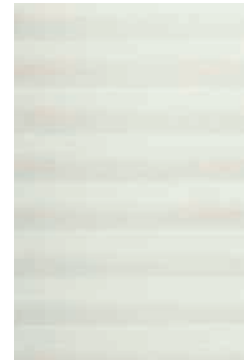

White Saraya
RE:171



Ivory Saraya
RE:179



Bronze Mother of pearl
RE:755



Shiny Glitten
RE:747/S



Matt Glitten
RE:747/M



Shiny white
RE:702/S

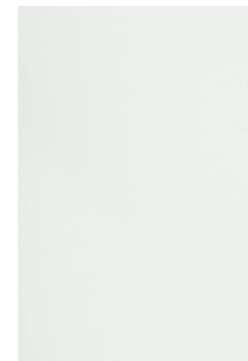

Matt white
RE:702/M



Shiny white Mother of pearl
RE:735/S

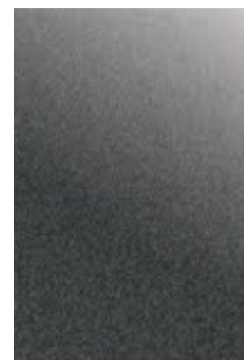

Shiny Gun Barrel
RE:727



Shiny grey Mother of pearl
RE:765/S



Matt grey Mother of pearl
RE:765/M



Shiny grey
RE:764/S



Matt grey
RE:764/M

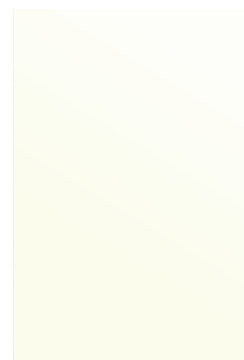

Shiny ivory
RE:703/S



Shiny dark grey
RE:758/S

LACCATURE LACQUERING



Matt dark grey
RE:758/M



Shiny greige
RE:722/S



White Silk
RE:731

Possiamo realizzare laccature in qualsiasi colore.
Lacquering can be done in any colour.

LACCATURE EFFETTO METALLO METAL EFFECT LACQUERING



Varnish satin Burnished
RE:775/MT



Varnish natural satin
Brass RE:751/MT



Varnish satin Lady
bronze RE:776/MT



Varnish satin black
London RE:780/MT



Varnish satin Titanium
RE:753/MT



Varnish Nickel satin
RE:761/MT



Varnish Rose Gold
RE:754/MT



Varnish Champagne
RE:778/MT

Questi trattamenti possono essere eseguiti esclusivamente su metallo.
These treatments can only be applied to metal.

LACCATURE SU METALLO O LEGNO LACQUERED METAL OR WOOD

METALLO IN GALVANICA GALVANIC METAL COATING

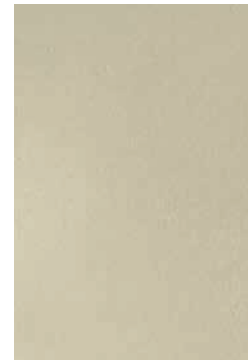

Varnish Titanium
RE:753



Varnish natural Brass
RE:751

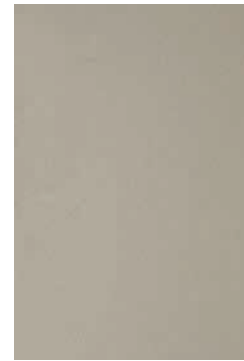

Varnish Lady bronze
RE:776



Varnish Nickel
RE:761

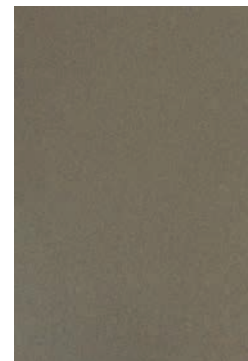

Varnish Burnished
RE:775

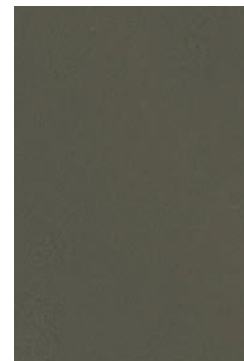

Varnish black London
RE:780

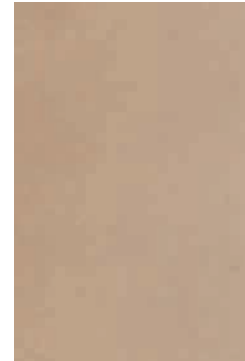

Varnish Rose Gold
RE:754



Champagne
Emperador
RE:778



Brass



Bronze



Satin Nickel



Champagne



Gold

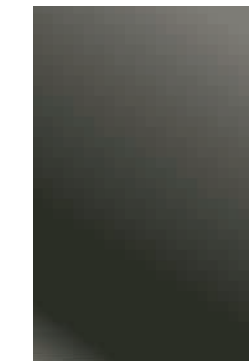

Black Nickel



Chrome

Questi trattamenti possono essere eseguiti sia su metallo che su legno.
These treatments can be applied to metal and wood.

MARMI MARBLES



Biancone



Arabescato



Calacatta Gold

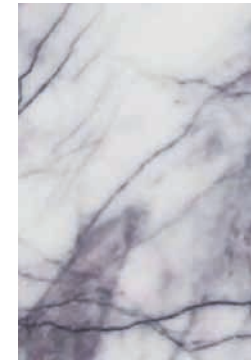

Lilac



Dover white



Arabescato viola

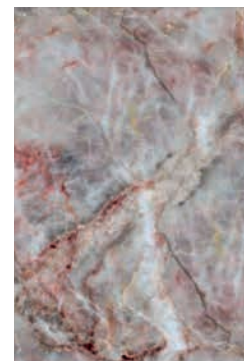

Fior di pesco



Grey Bardiglio

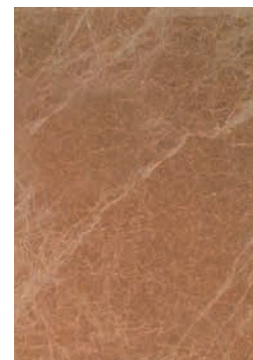

Emperador light



Travertino Noce



Botticino



Travertino Gold



London Grey

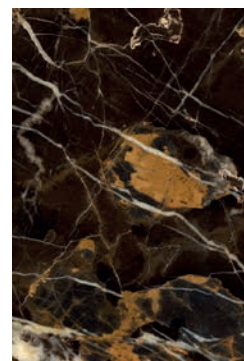

Black gold

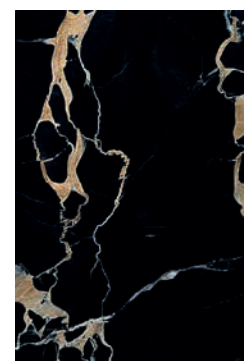

Portoro

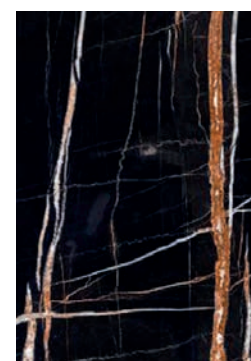

Sahara noir

MARMI MARBLES



Onice verde



Greenish Gold

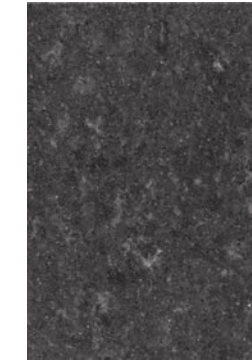

Stone Grey Lux



Red Orobico Shiny

Le immagini sono indicative essendo il marmo un materiale naturale e mutevole.
The images are indicative as marble is a natural and changing material.

Le lastre di marmo vengono selezionate di volta in volta secondo le nostre condizioni generali di vendita.
The marble slabs are selected according to our general conditions of sale.

VETRO & SPECCHIO GLASS & MIRROR



Transparent glass
Bronze



Transparent glass grey
Smoke



Europe grey mirror



Bronze mirror



Golden mirror



Natural mirror

VETRO DECORATIVO DECORATIVE GLASS



Trinity with bronze mirror
RE:1012



Tartan with bronze mirror
RE:1011



Diamond with bronze mirror
RE:1010



Technical BOOK

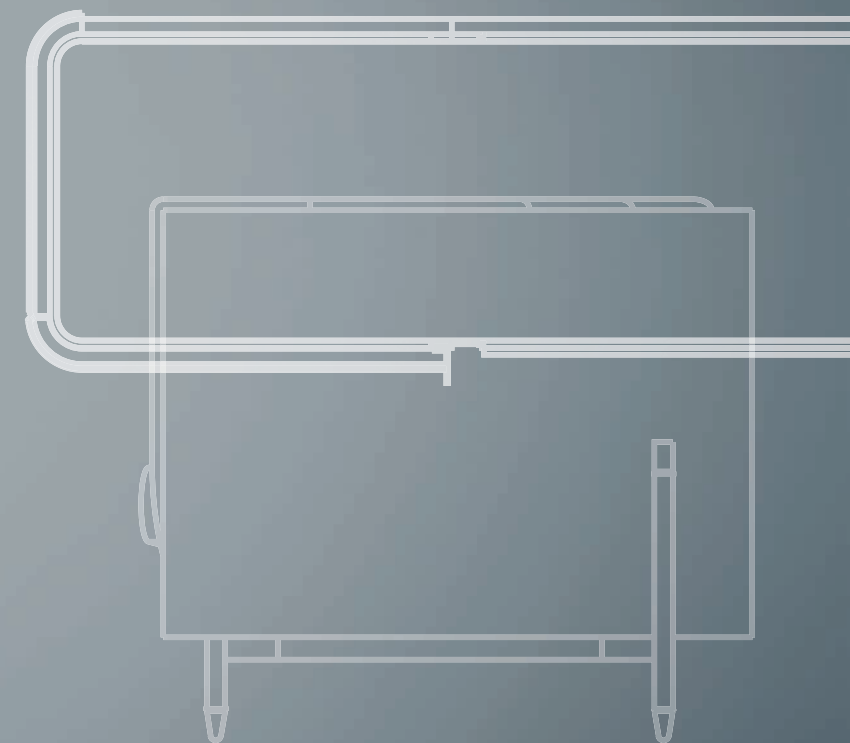
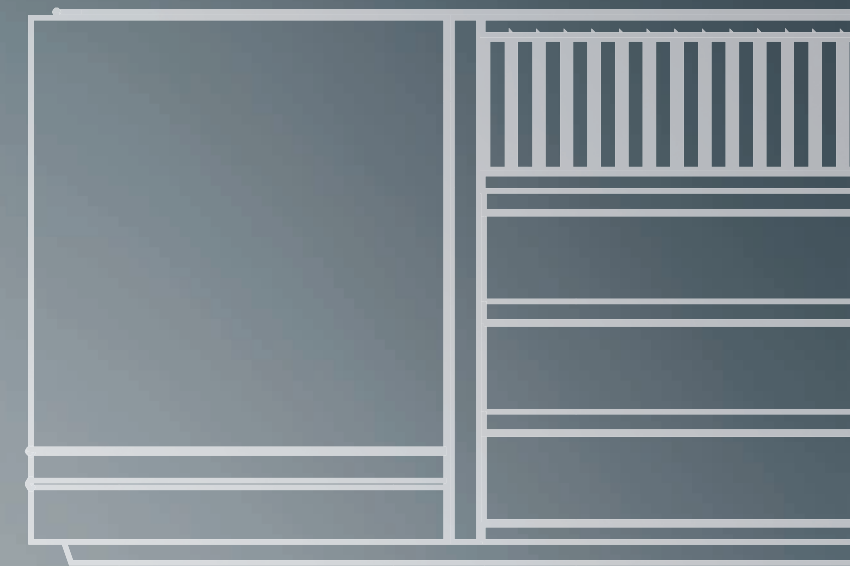

VESTA Composition 01

Divano modulare
Modular sofa

Cm.206x93x78h.

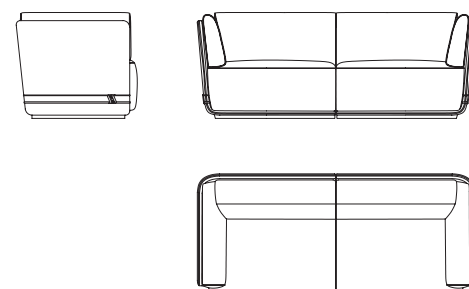

VESTA Composition 02

Divano modulare
Modular sofa

Cm.260x93x78h.

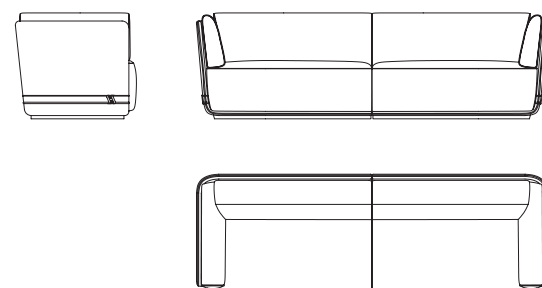

VESTA Composition 03

Divano modulare
Modular sofa

Cm.308x93x78h.

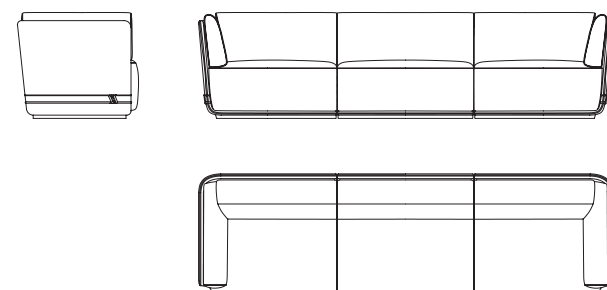

VESTA Composition 04

Divano angolare
Sectional sofa

Cm.298x298x78h.

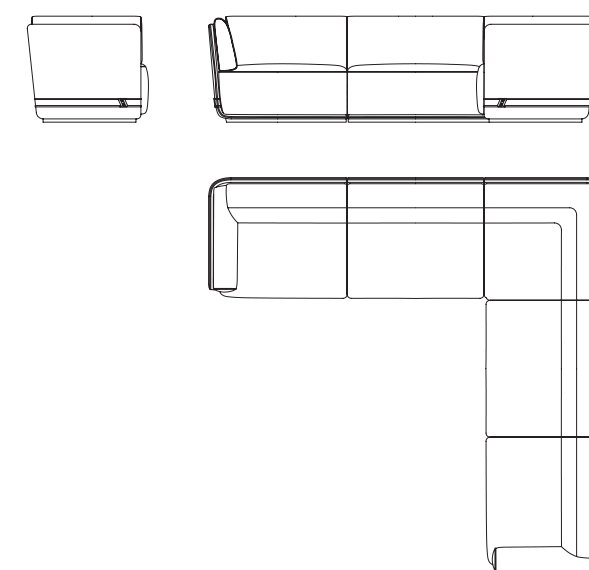

VESTA S 1501/SX-DX

Elemento terminale
Terminal element

Cm.103x93x78h.

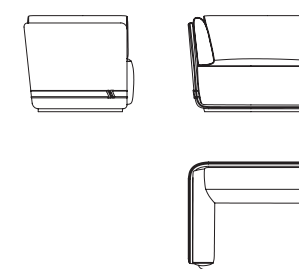

VESTA S 1502

Elemento centrale
Central element

Cm.102x93x78h.

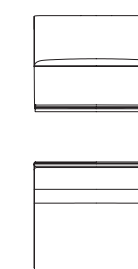

VESTA S 1503

Elemento angolare
Corner element

Cm.93x93x78h.

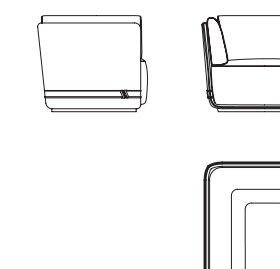

ETRA LINE Composition 01

Divano componibile
Modular sofa

Cm.177x102x96h.

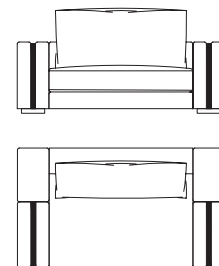

ETRA LINE Composition 02

Divano componibile
Modular sofa

Cm.300x102x96h.

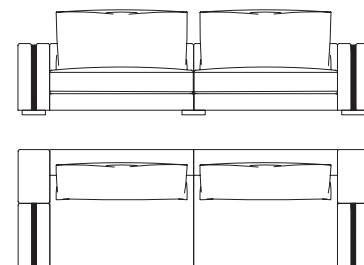

ETRA LINE Composition 03

Divano componibile
Modular sofa

Cm.423x102x96h.

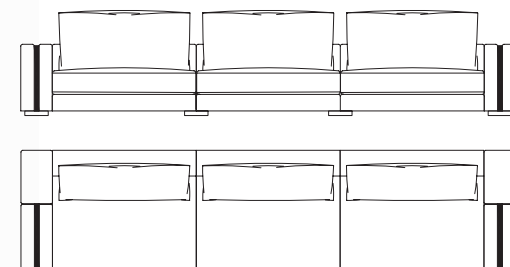

ETRA LINE Composition 05

Divano componibile
Modular sofa

Cm.423x173x96h.

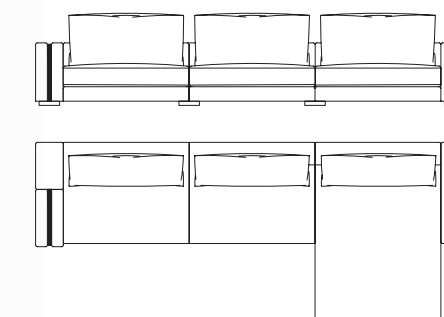

ETRA LINE S 1404

Elemento *Element*

Cm.102x102x96h.

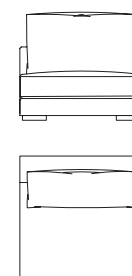

ETRA LINE S 1405

Elemento *Element*

Cm.123x102x96h.

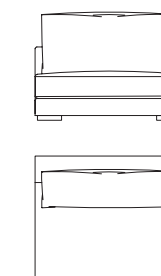

ETRA LINE S 1406

Elemento *Element*

Cm.102x137x96h.

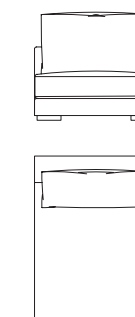

ETRA LINE S 1407

Elemento *Element*

Cm.123x137x96h.

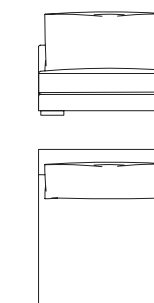

ETRA LINE S 1408

Elemento *Element*

Cm.102x173x96h.

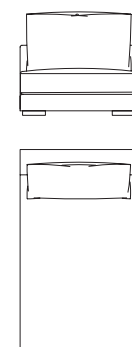

ETRA LINE S 1409

Elemento *Element*

Cm.123x173x96h.

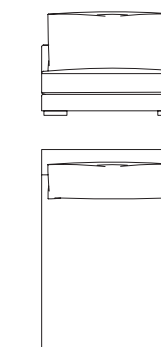

ETRA LINE S 1410

Elemento angolare
Corner *element*

Cm.102x102x96h.

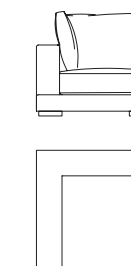

ETRA LINE AR 1411/1412

Bracciolo *Arm*

Cm.27x102x62h.

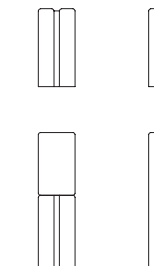

ETRA S 1402

Divano 2 posti
2 seaters sofa

Cm.199x92x75h.

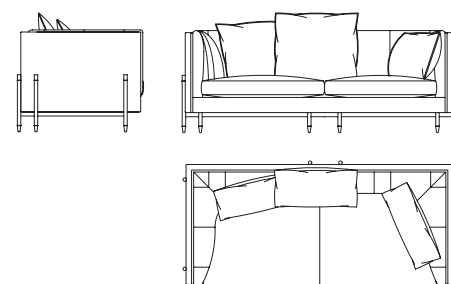

ETRA S 1403

Divano 3 posti
3 seaters sofa

Cm.241x92x75h.

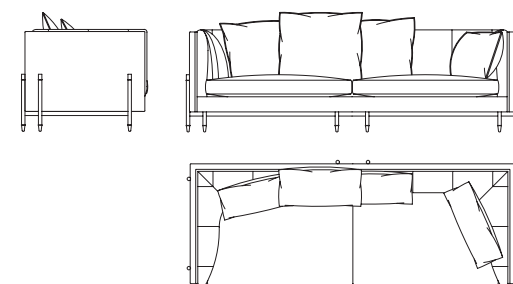

ZEUS S 3013

Divano 3 posti
3 seaters sofa

Cm.229x105x80h.

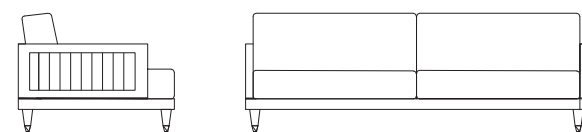

VESTA S 1504

Poltrona Armchair

Cm.110x93x78h.

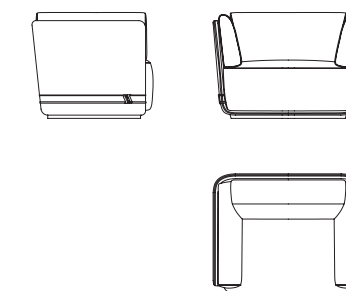

VESTA S 1501 SX/DX

Elemento terminale
Terminal element

Cm.103x93x78h.

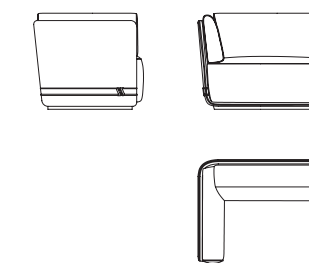

ETRA LA 1401

Poltrona Armchair

Cm.73x73x68h.

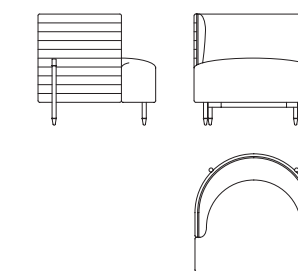

ETRA LA 1402
Poltrona *Armchair*

Cm. 85x84x74h.

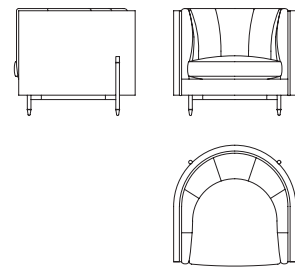

ETRA S 1401
Poltrona *Armchair*

Cm. 122x92x75h.

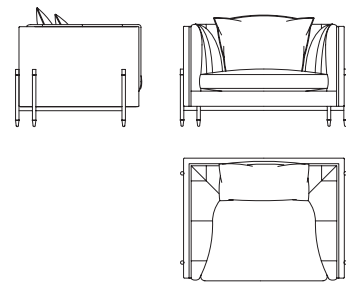

ETRA LA 1405
Poltrona *Armchair*

Cm. 98x90x72h.

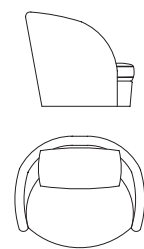

ETRA LA 1404
Poltrona *Armchair*

Cm. 73x68x74h.

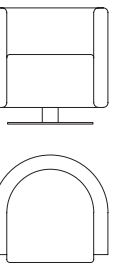

PENELOPE LA 1021
Poltrona *Armchair*

Cm. 64x58x69h.

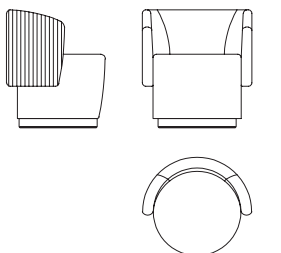

PENELOPE LA 1016
Poltroncina *Little armchair*

Cm. 69,5x77,5x69h.

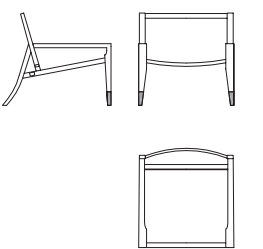

ETRA P 1404
Pouf Pouff

Cm. Ø75x38h.

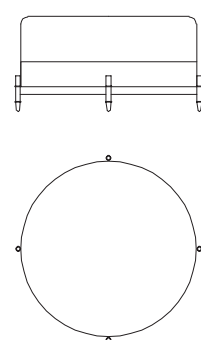

ULYSSE P 742
Pouff Pouf

Cm. Ø45x45h.

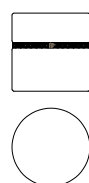

ETRA P 1402
Panca Bench

Cm. 207x80x52h.

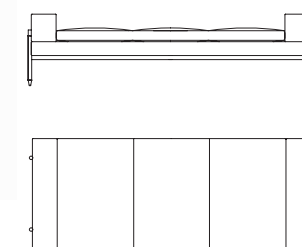

ETRA P 1401
Panca Bench

Cm. 152x80x52h

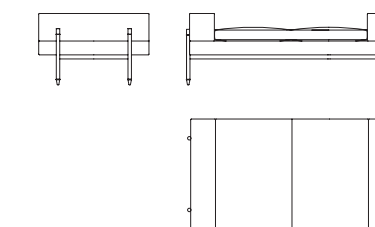

ETRA P 1403
Panca Bench

Cm. 100x45x48h.

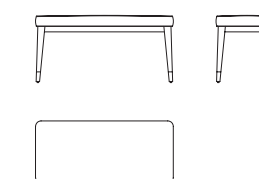

LATINO P 1210
Panca Bench

Cm. 140x50x46h.

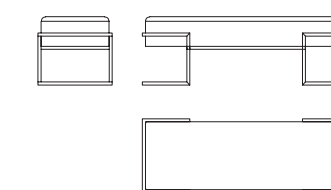

ETRA LA 1403
Sedia Chair

Cm.62x62x82h.

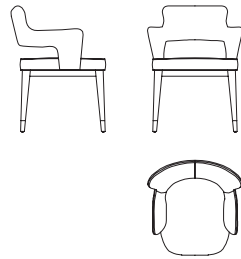

PENELOPE LA 1012
Sedia Chair

Cm.60x56x90h.

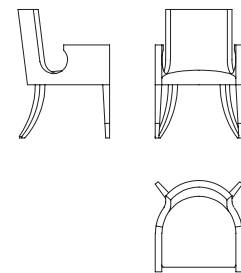

VESTA LA 1501
Sedia Chair

Cm.63x57x80h.

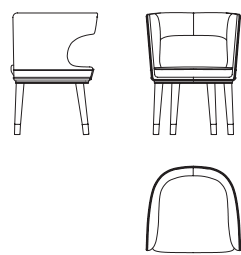

LATINO LA 1211
Sedia Chair

Cm.63x60,5x80h.



VESTA LA 1503
Sedia Chair

Cm.63x63x86h.

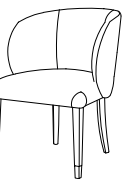

VESTA LA 1504
Sedia Chair

Cm.62x55x86h.



VESTA LA 1502

Sedia *Chair*

Cm.69,5x77,5x69h.



ETRA LA 1407

Sgabello *Stool*

Cm.Ø46x68h.

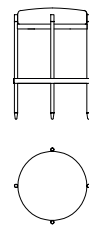

LATINO LA 1212

Sgabello *Stool*

Cm.63x60,5x95h.

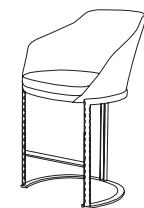

VESTA T 1503

Tavolo *Table*

Cm.Ø160x76h.

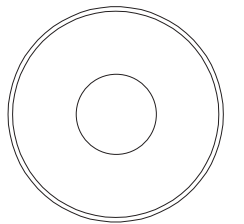
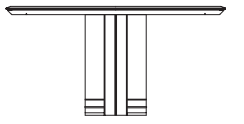

VESTA T 1503

Tavolo *Table*

Cm.Ø180x76h.

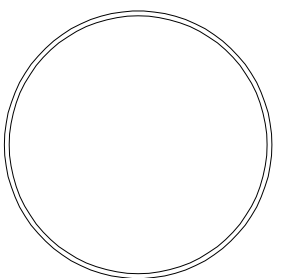
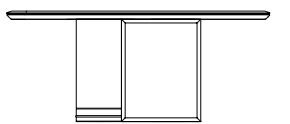

VESTA T 1501
Tavolo Table

Cm. 380x130x76h.

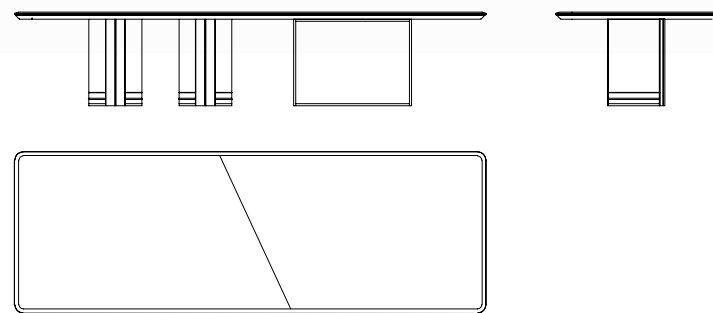

VESTA T 1502
Tavolo Table

Cm. 270x110x76h.

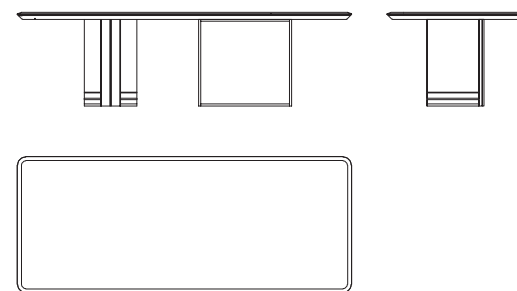

VESTA T 1504
Tavolo Table

Cm. 300x130x76h.

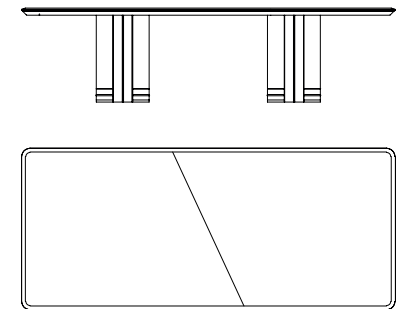

VESTA T 1506
Tavolo Table

Cm. 200x200x76h.

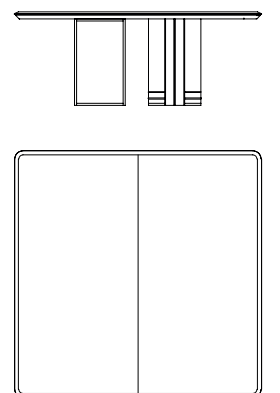

VESTA T 1505
Tavolo Table

Cm. Ø230x76h.

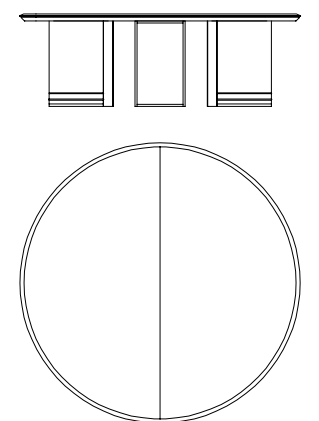

VESTA AT 1501
Tavolino Coffee table
Cm. Ø55x60h.

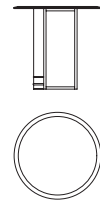

VESTA AT 1502
Tavolino Coffee table
Cm. Ø120x40h.

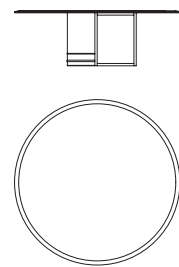

VESTA AT 1503
Tavolino Coffee table
Cm. Ø115x36h.

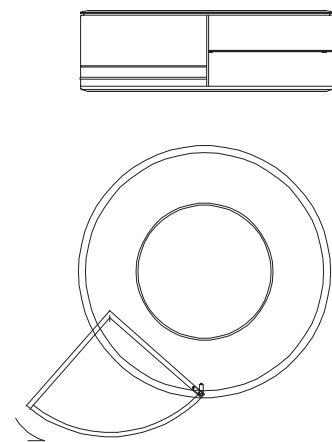

ETRA AT 1404
Tavolino Coffee table
Cm. 80x80x42h.

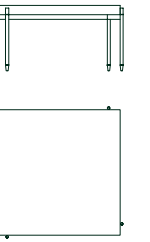

ETRA AT 1401
Tavolino Coffee table
Cm. 48,7x48,7x41,5h.

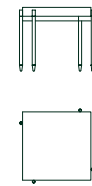

ETRA AT 1407
Tavolino Coffee table
Cm. 90x90x42h.

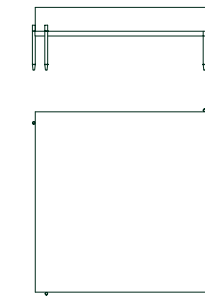

ETRA AT 1408
Tavolino Coffee table
Cm. 120x120x42h.

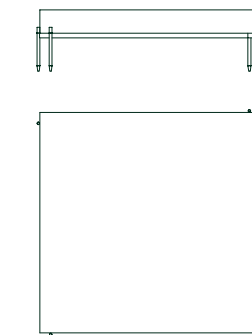

ETRA AT 1406
Tavolino Coffee table
Cm. 70x140x42h.

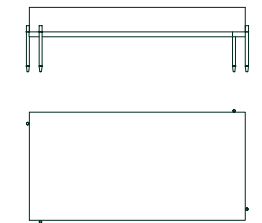

ETRA AT 1402
Tavolino Coffee table
Ø58x42h.



ETRA AT 1405
Tavolino Coffee table
Ø90x42h.

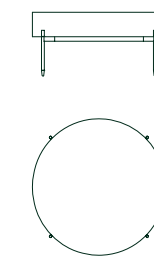

ETRA AT 1409
Tavolino Coffee table
Ø90x33h.

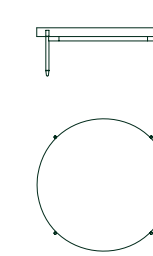

ETRA AT 1410
Tavolino lungo
Long coffee table

Cm. 194x49x45h

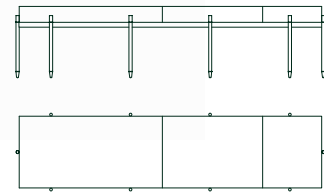

ETRA AT 1411
Tavolino lungo
Long coffee table

Cm. 153x49x45h

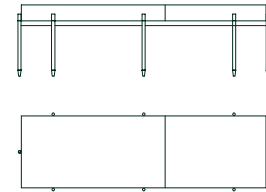

ETRA AT 1413
Tavolino Coffee Table

Cm. Ø74x41h.

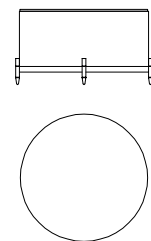

ETRA AT 1414
Tavolino con saliscendi
Coffee Table with Sliding Mechanism

Cm. Ø74x41/59h.

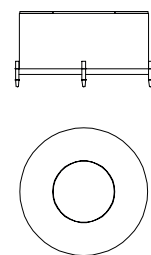

TESEO AT 1301
Tavolino Coffee table

Cm. 87x87x36h.

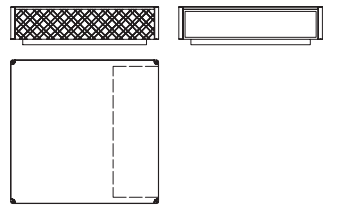
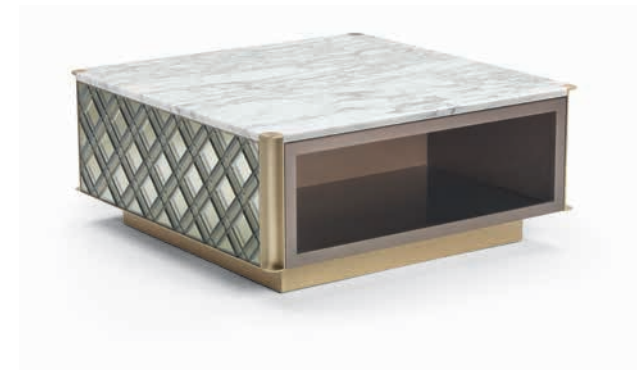

TESEO AT 1305
Tavolino Coffee table

Cm. 59x59x48h.

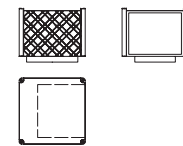

TESEO AT 1302
Tavolino Coffee table

Cm. 91x91x27h.

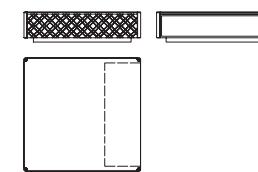

TESEO AT 1303
Tavolino Coffee table

Cm. 138x138x36h.

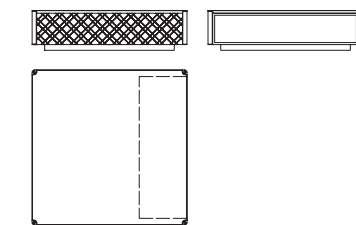

TESEO AT 1304
Tavolino Coffee table

Cm. 142x142x27h.

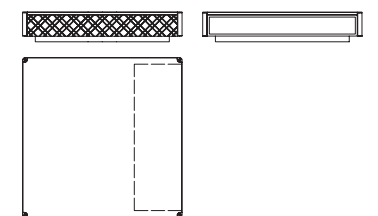

ULISSE AT 760/44-MA
Tavolino con piano in marmo
Coffee table with marble top

Cm. Ø60x44h.

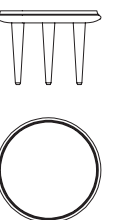

ETRA C 1404-MA

Credenza 4 ante con piano in marmo
4 doors sideboard with marble top

Cm. 240x51x87h.

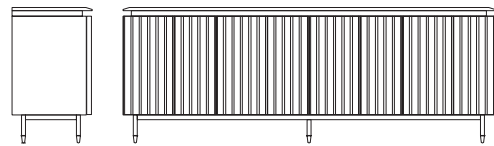

ETRA C 1402-MA

Credenza 2 ante con piano in marmo
2 doors sideboard with marble top

Cm. 121x51x87h.

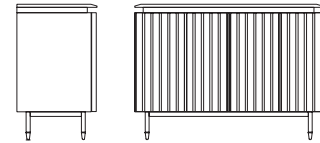

ETRA C 1403-MA

Credenza 3 ante con piano in marmo
3 doors sideboard with marble top

Cm. 182x51x87h.

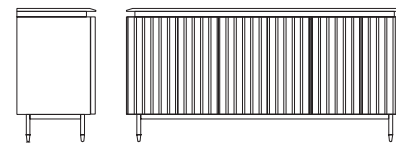

ETRA C 1414

Credenza 4 ante
4 doors sideboard

Cm. 202x52x68h

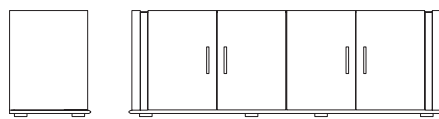

ETRA C 1412

Credenza 2 ante
2 doors sideboard

Cm. 113x52x68h

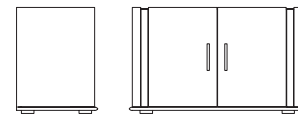

ETRA C 1413

Credenza 3 ante
3 doors sideboard

Cm. 158x52x68h

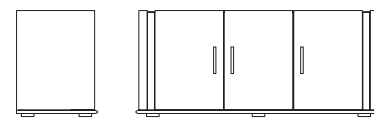

PENELOPE C 1023-L

Credenza 3 ante
3 doors sideboard

Cm. 165x50x85h.

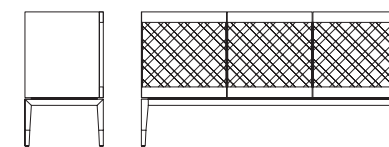

PENELOPE C 1022

Credenza 2 ante
2 doors sideboard

Cm. 110x50x85h.

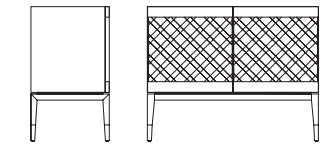

PENELOPE C 1024-L

Credenza 4 ante
4 doors sideboard

Cm. 220x50x85h.

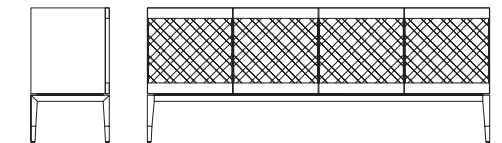

ULYSSE C 794

Credenza 4 ante
4 doors sideboard

Cm. 228,5x56,7x94,5h

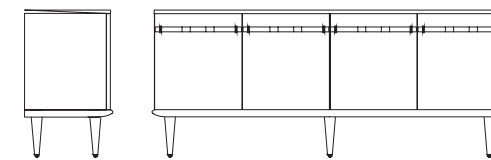

ULYSSE C 793

Credenza 3 ante
3 doors sideboard

Cm. 172x56,7x94,5h

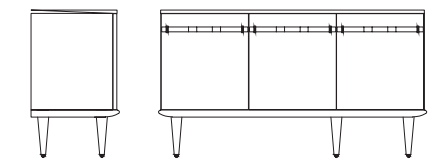

VESTA C 1501

Credenza Sideboard

Cm. 223x52x78h.

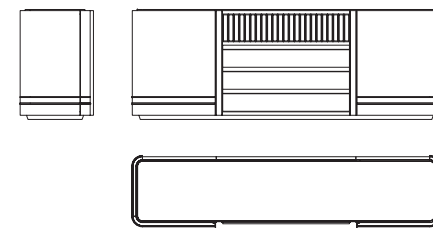

VESTA C 1502

Credenza alta High sideboard

Cm. 134x61x178h.

VESTA C 1502-B

Credenza alta High sideboard

Cm. 134x61x178h.

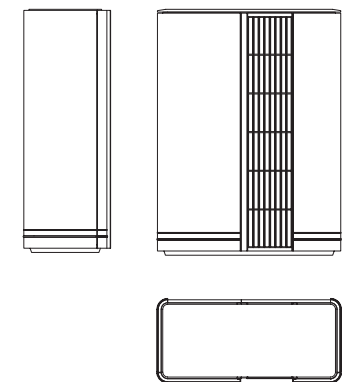

ETRA C 1401-MA

Madia 2 ante con fascia centrale in marmo
High sideboard with central marble

Cm. 120x51x163h.

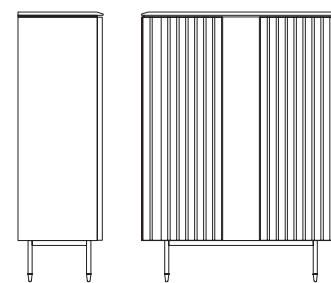

ULYSSE BC 751

Libreria Bookcase

Cm. 100x25x240h

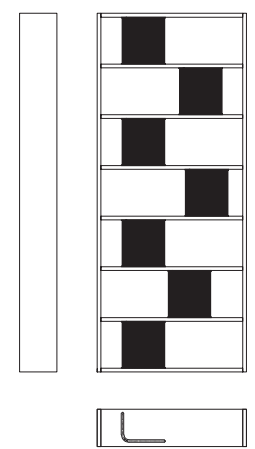

ETRA AH 1401
Porta tv Tv holder
Cm.206x53x45h

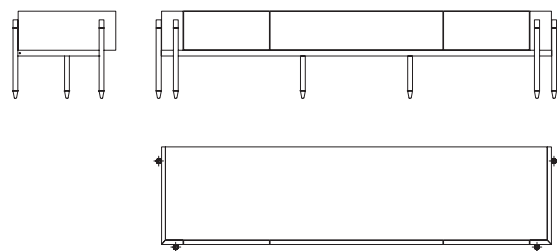

PENELOPE AH 1013-L
Porta tv Tv holder
Cm.165x50,5x60h.

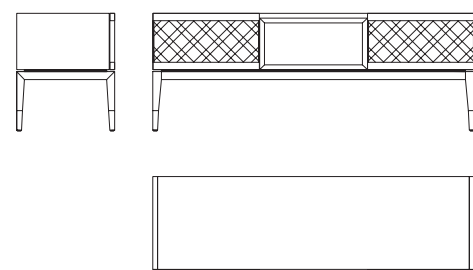
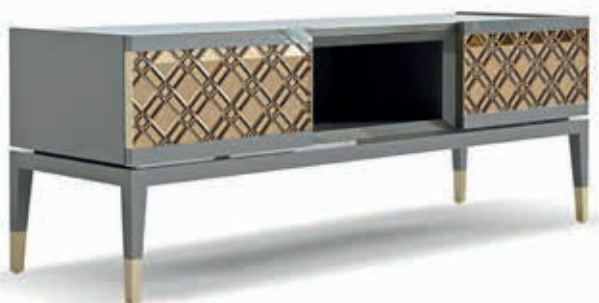

VESTA AH 1502
Porta tv Tv holder
Cm.223x51x58h.

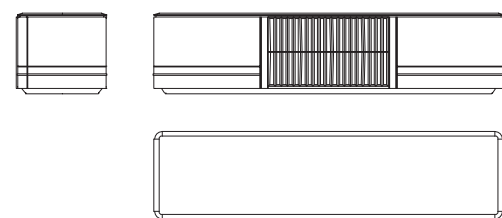

VESTA AC 1502
Consolle retro divano Back sofa console
Cm.185x45x55h.

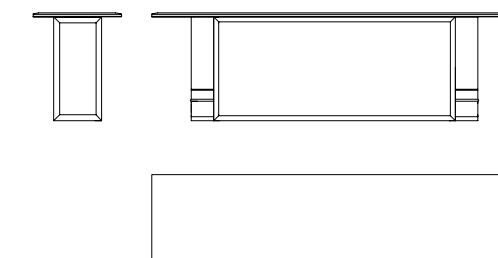

VESTA AC 1501
Consolle Console
Cm.185x45x77h.

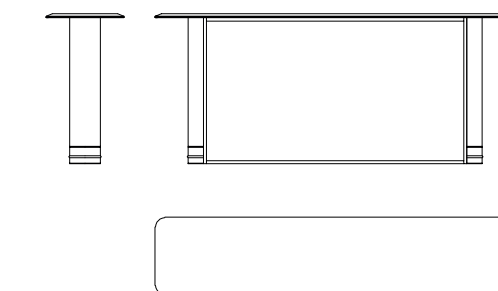

ETRA AT 1401
Consolle Console
Cm.125,6x42,8x85h.

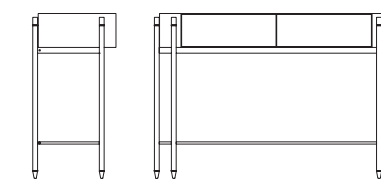

ETRA AS 1401

Scrivania *Desk*

Cm. 125,6x55,8x74h.

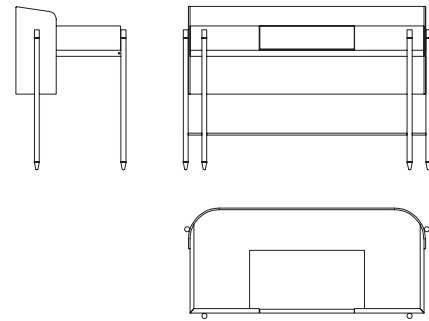

ULYSSE AC 740

Consolle *Console*

Cm. 150x45x80h.

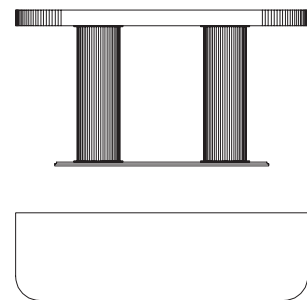

LATINO AC 1212

Consolle *Console*

Cm. 150x45,5x75h.

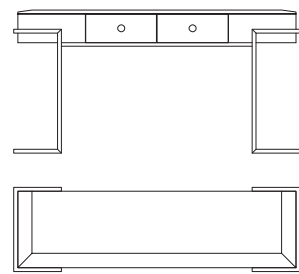

LATINO AC 1210

Consolle apribile
Opening console

Cm. 229x49x79h.

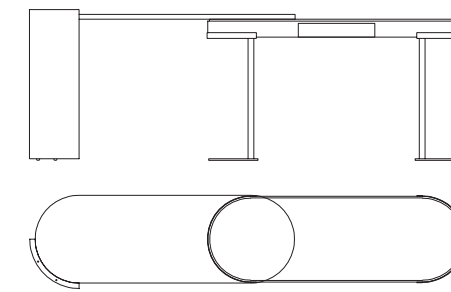

LATINO AC 1211-MA
Consolle con top in marmo
Console with marble top

Cm. 135,5x45,5x74h.

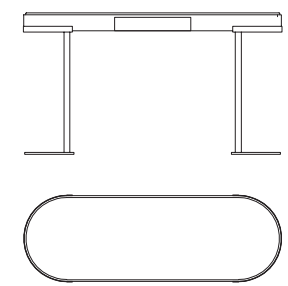

ETRA M 1401

Specchiera decorativa
Decorative mirror

Cm.131x7x91h.

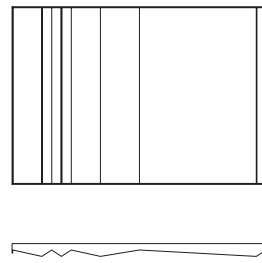

PENELOPE M 1011

Specchiera Mirror

Cm.80x170h.

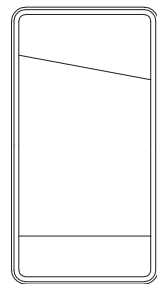

PENELOPE M 1010

Specchiera Mirror

Cm.200x5x45h.

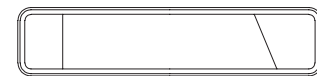

VESTA M 1501

Specchiera Mirror

Cm.Ø100h.

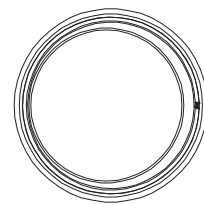

VESTA M 1502

Specchiera Mirror

Cm.Ø200h.

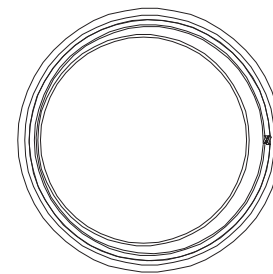

VESTA M 1503

Specchiera Mirror

Cm.104x204h.

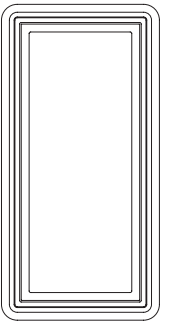

VESTA F 1501

Vaso Flower box

Cm.Ø36x106h.



VESTA F 1502

Vaso Flower box

Cm.Ø42x66h.

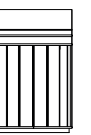

ETRA B 1410

Letto Bed

Cm.400x216x118h.



Materasso *Mattress*
Cm.195x195

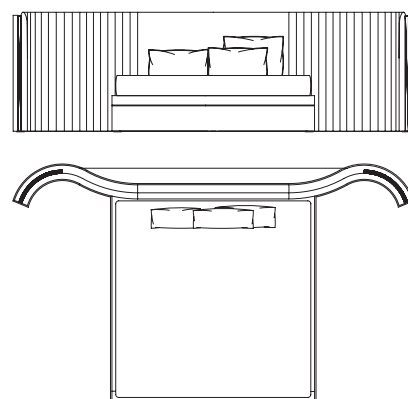

ETRA B 1406

Letto Bed

Cm.248x224x132h.

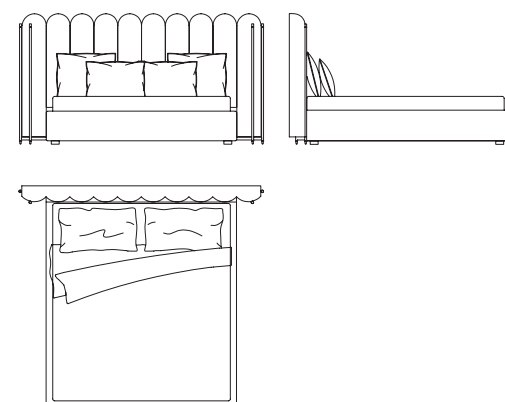

ETRA B 1404

Letto Bed

Cm.193x216x121h.

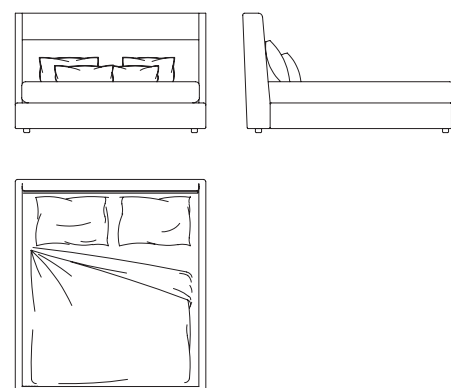

ETRA B 1405

Letto Bed

Cm.191x215x200h.

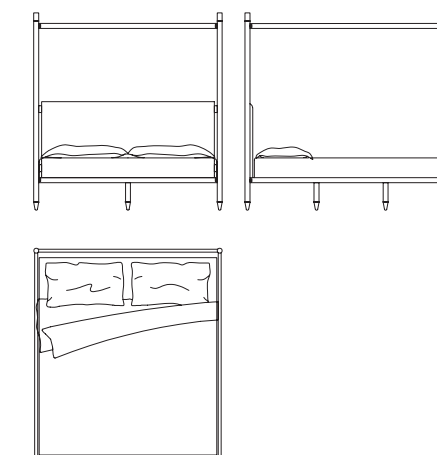

ETRA B 1401

Letto Bed

Cm.221,5x210x180h.

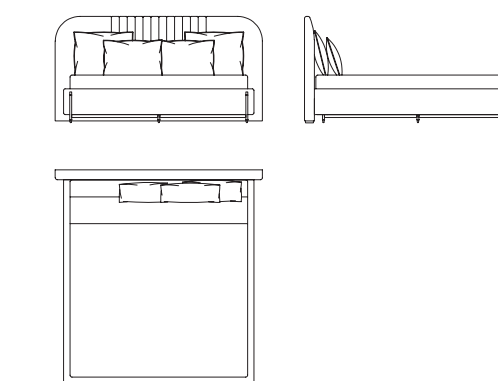

ETRA B 1408

Letto Bed

Cm.259x228x130h.

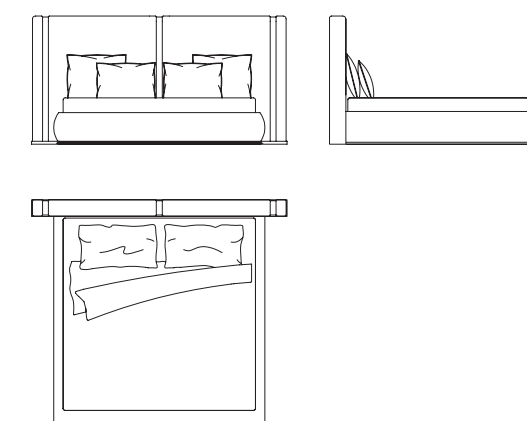

ETRA B 1409

Letto Bed

Cm.256x224x145h.

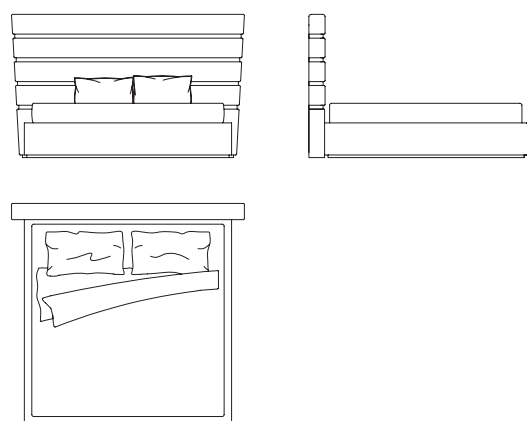

ETRA B 1407

Letto Bed

Cm.220x224x120h.

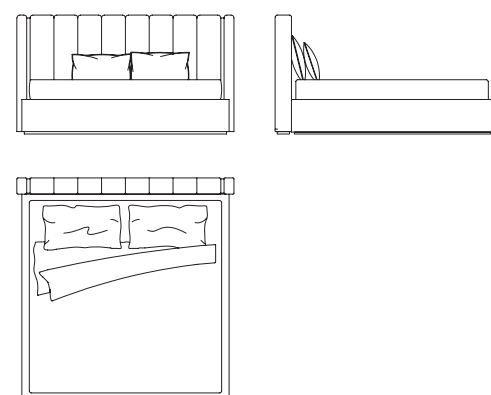

VESTA B 1501

Letto Bed

Cm.250x225x112h.

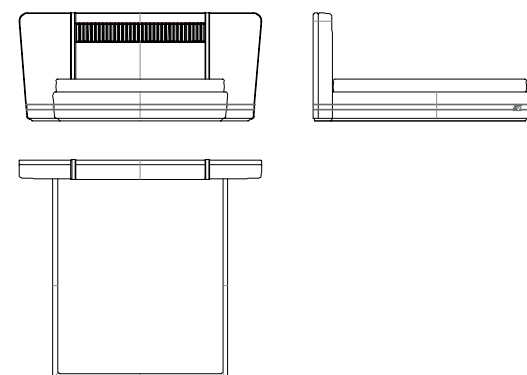

VESTA B 1502

Letto Bed

Cm.234x244x124h.

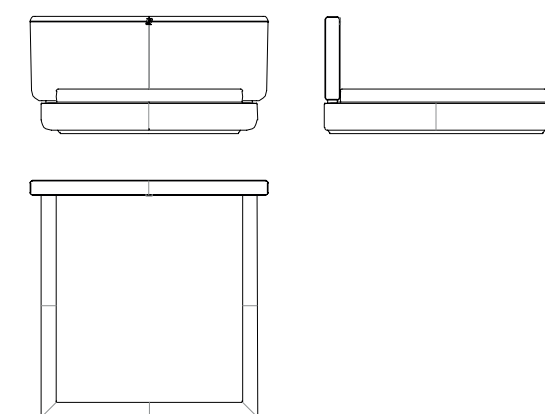

VESTA B 1503

Comodino Bedside table

Cm.60x40x48h.

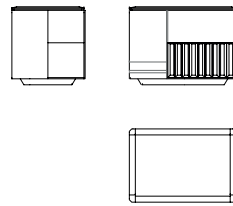

ULYSSE B 754

Comodino Bedside table

Cm.Ø50x57h.

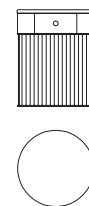

ETRA B 1412

Comodino Bedside table

Cm.67x48x46,5h.

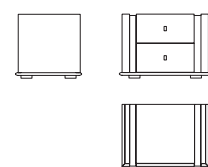

ETRA B 1414

Comodino Bedside table

Cm.61x37x45h.

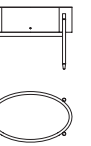

ETRA B 1402 SX/DX

Comodino Bedside table

Cm.61x51x43h.

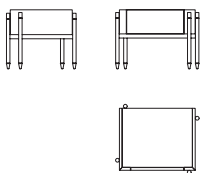

ETRA B 1403

Comò Chest of drawers

Cm.116,6x52,8x74h.

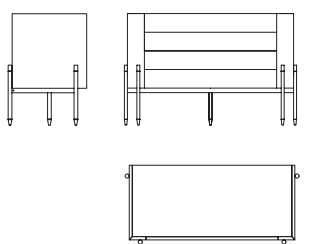

ETRA B 1415
Comò Chest of drawers
Cm. 180x58x84h.

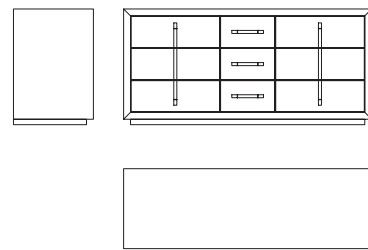

ETRA B 1413
Comò Chest of drawers
Cm. 134x53x75h.

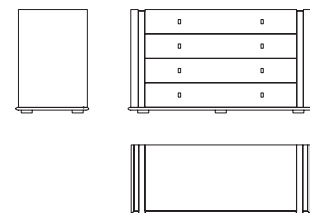

VESTA B 1504
Comò Chest of drawers
Cm. 180x56x80h.

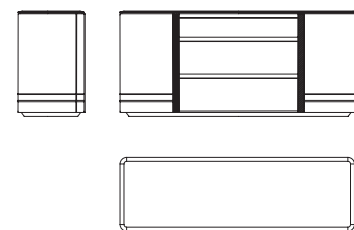

VESTA USC 1501
Scrivania Desk
Cm. 270x202x87h.

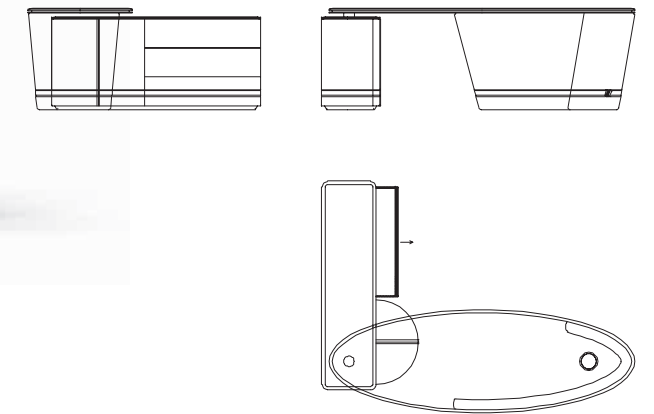

VESTA USC 1502
Scrivania Desk
Cm. 270x120x87h.

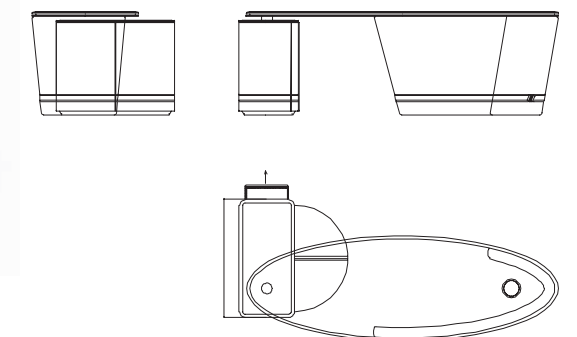

VESTA UMB 1501
Mobile tv Tv holder
Cm.265x55x178h.

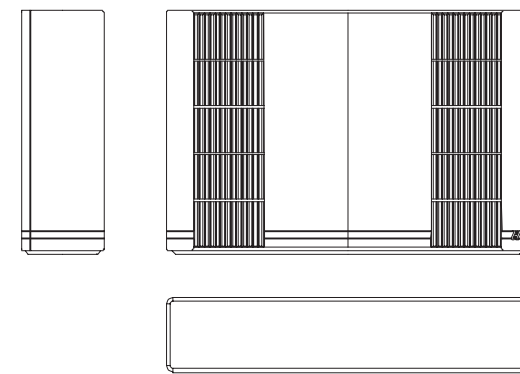

VESTA UMB 1502
Libreria Bookshelf
Cm.180x55x178h.

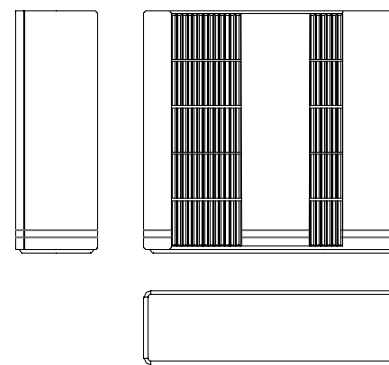

OPUS
Boiserie in legno
Wood wall paneling
Customisable on request



DECÒ
Misura massima senza giunzioni pannello in legno
Wood panel max size without joint
Cm.105x370h.

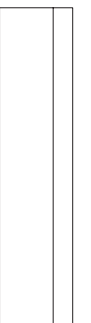
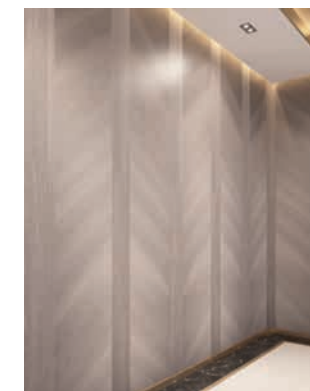

DECÒ
Boiserie in legno
Wood wall panel
Customisable on request

LAVINIA
Misura massima senza giunzioni pannello in legno
Wood panel max size without joint
Cm.105x370h.

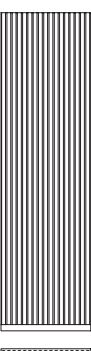
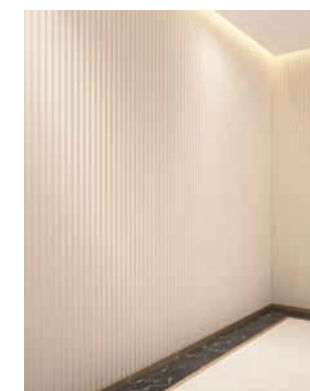

LAVINIA
Boiserie in tessuto
Fabric wall panel
Customisable on request

TESEO

Misura massima senza giunzioni pannello in legno
Wood panel max size without joint

Cm. 140x240h.



TESEO
Boiserie in vetro
Glass wall panel

Customisable on request

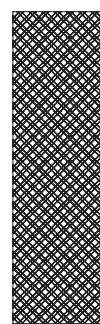

LAVINIA

Boiserie Boiserie

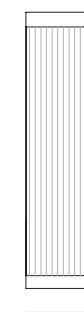
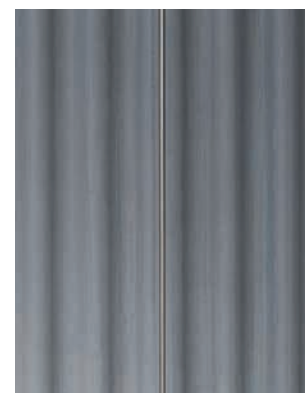

GREEK

Boiserie Boiserie

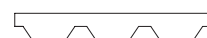
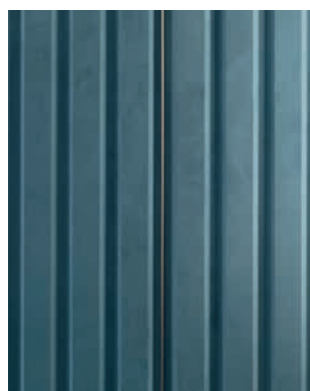

ALBION

Boiserie Boiserie

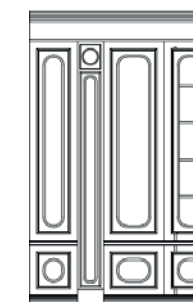

IONICA

Boiserie Boiserie



VESTA

Boiserie Boiserie

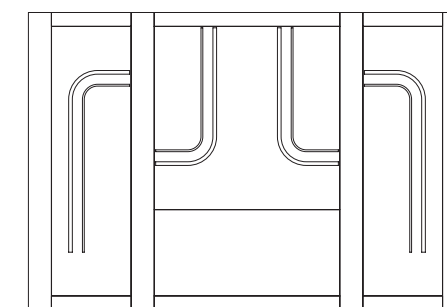

PENELOPE D 1502

Porta Door

Cm.300x310h.

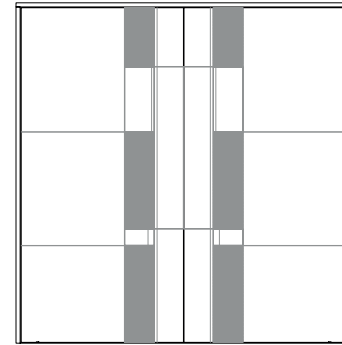
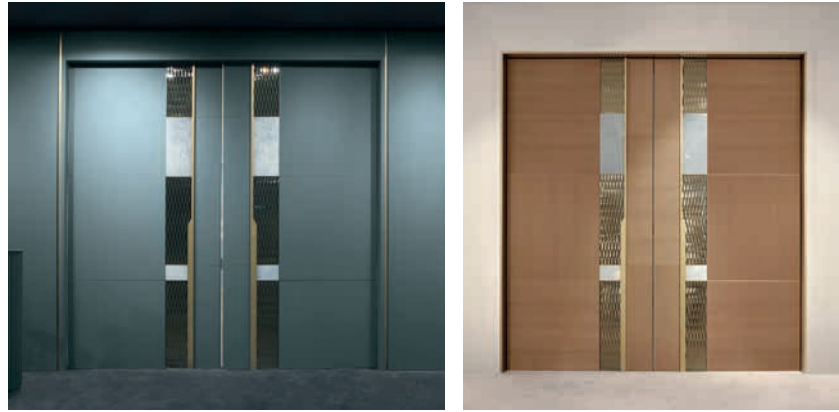

PENELOPE D 1501

Porta Door

Cm.150x310h.

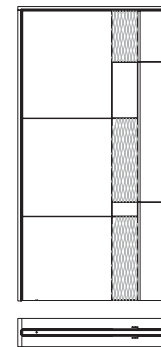

DECÒ

Porta Door

Cm.162x274h.

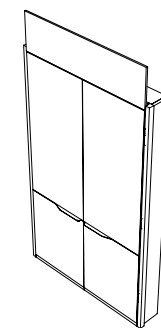
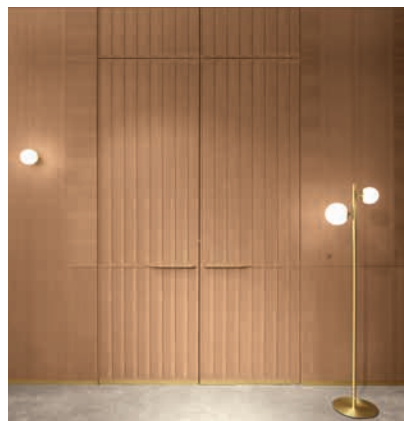

TWENTY

Porta Door

Cm.201x285h.

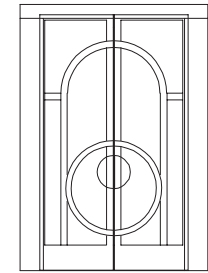

ALBION

Porta Door

Cm.243x297h.

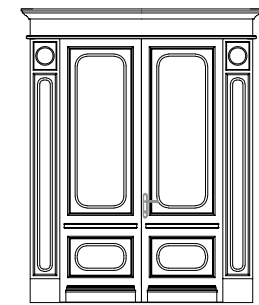

Nessuna parte di questo catalogo, testo o fotografia può essere riprodotta o trasmessa in qualsiasi forma o tramite mezzo elettronico o meccanico, comprese le fotocopie, senza previo permesso scritto da parte della società ELLEDUE S.r.l.

I colori dei legni, delle laccature, dei tessuti e delle pelli presenti in questo catalogo sono suscettibili dei procedimenti di stampa. Fa fede il campionario dell'azienda. ELLEDUE S.r.l si riserva la facoltà di modificare in qualunque momento e senza preavviso le caratteristiche tecniche (misure, finiture, tessuti e pelli) dei suoi prodotti.

No part of this catalogue, text or photograph may be reproduced or transmitted in any shape or form, through electronic or paper-based communication, including photocopies, without the prior express written consent of ELLEDUE S.r.l.

Wood, lacquer, fabric and leather colours are not binding and may vary due to printing.

Please refer to the company sets of samples. ELLEDUE S.r.l reserves the right to modify the technical specifications of the products (sizes, finishes, leather and fabrics) featured in this catalogue at any time and without prior notice.



OFFICE & FACTORY

Via Indipendenza, 194
20821 - Meda (MB) - Italy

www.elleduearredamenti.com

